



Bharat Heavy Electricals Limited

(A Govt. Of India Undertaking)

Power Sector, Eastern Region

BHEL Bhawan, Plot No. DJ-9/1, Sector- II,
Salt Lake City, Kolkata, WEST BENGAL, INDIA

Phone: 033-23398220, 23211690, FAX: 033-
23211960

NOTICE INVITING TENDER (NIT)

OFFERS ARE INVITED FROM REPUTED & EXPERIENCED BIDDERS (MEETING PRE-QUALIFICATION CRITERIA AS MENTIONED) **THROUGH NIC E-PROCUREMENT PORTAL <https://eprocurebhel.co.in> ONLY** for THE SUBJECT JOB BY THE UNDERSIGNED ON BEHALF OF BHARAT HEAVY ELECTRICALS LIMITED AS PER THE TENDER DOCUMENT. ISSUE OF TENDER TO ANY BIDDER SHALL NOT CONSTRUCT THAT THE BIDDER IS CONSIDERED TO BE QUALIFIED. FOLLOWING POINTS RELEVANT TO THE TENDER MAY PLEASE BE NOTED AND COMPLIED WITH.

Salient Features of NIT

SL NO	ISSUE	DESCRIPTION	
i	E-TENDER NUMBER	PSER:PUR:CESC-S501:22 (ENQ:22:PP:0015:PUR:91) Date 25/11/2022.	
ii	Broad Scope of job	“OVERHAULING OF TURBINE (HP & LP), GENERATOR AND AUXILIARY WORKS AT UNIT-3, 250 MW (KWU DESIGN), BUDGE BUDGE, CESC, WEST BENGAL”.	
iii	ISSUE OF TENDER DOCUMENTS	a) <i>Online through e-procurement platform at https://eprocurebhel.co.in</i> b) In BHEL website (www.bhel.com & CPP Portal) : For tender view purpose only Start date of the tender: 25/11/2022	1. Applicable 2. Applicable
iv	DUE DATE & TIME OF OFFER SUBMISSION	<i>Date: 28/11/2022, Time: 14-00 Hrs. IST</i> <i>(Offer to be submitted online only through e-procurement platform at https://eprocurebhel.co.in)</i>	Applicable
v	TECHNO-COMMERCIAL BID OPENING OF TENDER	<i>Date: 28/11/2022, Time: 16-30 Hrs. IST</i> <i>(online only through e-procurement platform at https://eprocurebhel.co.in, participating bidders may witness the same online only)</i>	Applicable
vi	EMD AMOUNT	<i>INR 1,66,713.00 (Indian Rupees One Lakh Sixty Six Thousand Seven Hundred Thirteen Only)</i> <i>[To be submitted in the form and manner as mentioned below]</i>	Applicable
vii	COST OF TENDER	--	Not Applicable
viii	LAST DATE FOR SEEKING CLARIFICATION	<i>Date: 28/11/2022 (UP TO 11:00 Hrs.)</i>	Applicable
ix	SCHEDULE OF Pre Bid Discussion (PBD)	If any, shall be intimated through Tender Change Notice (TCN)	Not Applicable
x	INTEGRITY PACT & DETAILS OF INDEPENDENT EXTERNAL MONITOR (IEM)	--	Not Applicable

xi	Latest updates	Latest updates on the important dates, Amendments, Correspondences, Corrigenda, Clarifications, Changes, Errata, Modifications, Revisions, etc. to Tender Specifications will be hosted in BHEL webpage (www.bhel.com) →Tender Notifications →View Corrigendum & CPP Portal →Tender Notice & E-PROCUREMENT PORTAL https://eprocarebhel.co.in . Bidders to keep themselves updated with all such information.	<i>Shall be intimated to bidder</i>
xii	Evaluation currency	INDIAN RUPEES (INR)	

The offer shall be submitted as per the instructions of tender document. Only One set of tender document (**in original, downloaded from website**) signed by authorised company rep. of bidder and stamped on each page shall be submitted as detailed further, as given below. Bidders to note specifically that all pages of tender document, including these NIT pages etc. appearing in the website for this particular tender shall be submitted by them (after signing/stamping on each page) as a part of their offer. **Price shall not be mentioned by them anywhere in the techno-commercial portion of offer. Price shall be mentioned in the relevant price schedule only and to be submitted in e-procurement portal/platform in the form and manner mentioned in tender.**

For E-PROCUREMENT ASSISTANCE & TRAINING, NIC PORTAL HELPDESK CONTACTS AS PER FOLLOWING: -

For any technical related queries please call at 24 x 7 Help Desk Number
0120-4001 002

0120-4200 462

0120-4001 005

0120-6277 787

Email Support

Address: A) For any Issues or Clarifications relating to the published tenders, bidders are requested to contact the respective Tender Inviting Authority

Technical - support-eproc@nic.in

or for any difficulty in downloading the tender from internet website, they should contact this office (Dy. Engineer, Purchase or Manager, Purchase or DGM, Purchase Phone no. 033-23398261/8223/8220). No alteration/changes by bidders is permitted in the tender/NIT appeared in the website.

- 1.0 Successful bidder shall have to submit additional set of tender/sign on tender document provided by BHEL, if so decided by BHEL.
- 2.0 **Earnest Money Deposit (EMD) of INR 1,66,713.00 (Indian Rupees One Lakh Sixty Six Thousand Seven Hundred Thirteen Only)** in the form & manner prescribed in tender, shall be submitted by bidder as mentioned below, failing which the bidder's offer is liable for rejection.

SCAN COPY OF DOCUMENTS IN SUPPORT OF SUBMISSION OF EMD TO BE UPLOADED ALONG WITH TECHNO-COMMERCIAL OFFER IN NIC E-PROCUREMENT PORTAL/PLATFORM. IN CASE OF EMD SUBMISSION THROUGH BANKER'S CHEQUE/PAY ORDER/DEMAND DRAFT, SAME TO BE SUBMITTED IN SEALED ENVELOPE (SUPERSCRIBING TENDER REFERENCE) TO DGM-PURCHASE/MANAGER-PURCHASE/DY. ENGINEER-PURCHASE, BHEL BHAWAN, DJ-9/1, SECTOR-2,

KARUNAMOYEE, SALT LAKE CITY, KOLKATA-700091, WEST BENGAL PRIOR TO LATEST DUE DATE OF SUBMISSION OF OFFER.

One time EMD of Rs. 5,00,000/- (Rupees Five Lakh only) for BHEL-PSER, SAS jobs will also be valid for all such PSER-SAS jobs. Parties/bidders who have submitted/submits One Time EMD (OEMD) in this Power Sector Region (i.e. BHEL-PSER) for Service After Sales (SAS) a sum of amount Rs. 5,00,000/- (Rupees Five Lakh only) are exempted from payment of E.M.D. on each such tender in that unit on case to case basis. (evidence of deposit must be submitted in scanned copy and to be uploaded along with techno-commercial offer in NIC E-PROCUREMENT portal/platform) will be exempted from submission of EMD with this tender. The followings may be noted:

In case the bidder deposits separate EMD as mentioned above, there will be no change

- a) In existing clauses of this tender.
- b) In case of bidders having one time EMD; one time EMD can not be used for SD purpose.
- c) Security deposit shall be submitted as per provision of tender.
- d) **The EMD shall be enclosed with the Techno-Commercial Bid in the form and manner as mentioned above.**

3.0 This is an E-tender floated online through our E-Procurement Site <https://eprocurebhel.co.in>. The bidder should respond by submitting their offer online only in our e-Procurement platform at <https://eprocurebhel.co.in>. Offers are invited in two-parts only. No Hard copy bid or bids through email/ fax shall be accepted. Bids are invited in two parts & shall be submitted as described below:

OFFER DESCRIPTION	DOCUMENTS TO BE UPLOADED & MODALITY OF UPLOADING
TECHNICAL OFFER	1. Scanned copy of Covering letter of offer (To be attached in relevant Attachment section) 2. Scanned copy of Entire tender documents signed & stamped in each page by authorized representative of the bidder except price bid (To be attached in relevant Attachment section). 3. Scanned copy of Techno-Commercial Offer (To be attached in relevant Attachment section) 4. Duly filled all annexures except price & unpriced format (To be attached in relevant Attachment section). 5. Copy of records notes of Pre-Bid Conference, if applicable/ pre-bid MOM. (To be attached in relevant Attachment section) 6. Copy of Tender change notice (TCN), if applicable (To be attached in relevant Attachment section) 7. All supporting documents/ Annexures etc. as applicable (To be attached in relevant Attachment section). 8. No deviation certificate in bidder's letterhead as per format given in Tender (To be attached in relevant Attachment section).
PRE-QUALIFICATION PART	9. Pre-qualifying documents with all credentials as per tender. (To be attached in relevant Attachment section)
UNPRICED PRICE BID	10. Price schedule – Unpriced but mentioning only quoted / unquoted against each item as per tender. (To be attached in Unpriced bid Attachment section)
PRICE BID	11. Duly filled in Price Schedule as per tender. (To be attached in price bid Attachment section) Any other document uploaded in the price bid, apart from tendered Price schedule, shall not be taken into cognizance for evaluation of offer.

SPECIAL NOTE:

- A)** Offer & documents submitted with the offer shall be signed and stamped in each page by authorised representative of the bidder. No overwriting/correction in tender documents by bidders shall be allowed. However, if correction is unavoidable, the same may be signed by authorized signatory.
- B)** All documents / Annexures submitted with the offer shall be properly annexed and placed in respective places of the offer as per enclosure list mentioned in the covering letter. BHEL shall not be responsible for any missing documents.
- 4.0 No deviation with respect to tender clauses and no additional clauses/ suggestions/clarification in Techno-commercial bid/Price bid shall normally be considered by BHEL. Bidders are requested to positively comply with the same. Offers with deviation are liable for rejection.
- 5.0 BHEL reserves the right to accept or reject any or all offer without assigning any reasons thereof. BHEL also reserve the right to cancel the tender wholly or partly without assigning any reason thereof. BHEL also reserve the right to split/part award the job. Also, BHEL shall not entertain any correspondence from bidders in this matter (except for the refund of EMD).
- 6.0 Since the job shall be executed at site, the bidders must visit site/ work area and study the job content, facilities available, availability of materials, prevailing site conditions including Law and Order situation, applicable Wage structure, Wage rules, present condition of machines etc. before quoting for this tender. They may also consult this office before submitting their offers, for any clarifications regarding scope of work, facilities available at sites or on terms and conditions. No additional claim shall be entertained by BHEL in future, on account of non-acquaintance of site/machine conditions at the time of bidding.
- 7.0 For any clarification on the tender document, you may seek the same in writing or through e-procurement portal/platform as per specified format within the last date of seeking clarification as per tender. BHEL shall not be responsible for receipt of queries after due date of seeking clarification due to postal delay, and receipt of any query after due date shall not be entertained.
- 8.0 BHEL may decide holding Pre-bid Discussion [PBD] with all intending bidders. On such communication from BHEL, the bidder shall ensure participation for the same at the appointed time, date and place as may be decided by BHEL. Outcome of PBD (if any) shall also form part of tender.
- 9.0 In case of absence of any queries from bidder(s), their quoted price will be PRESUMED to be final and complete with reference to the tender documents (including Tender change notes (TCNs), clarifications, corrigendum issued by BHEL, if any). Bidders are requested to study the tender documents in detail and prepare their queries/clarifications accordingly. All such queries / clarifications shall be cleared/replied by BHEL. Such clarification letters, corrigendum and/or Tender change notes (TCNs), if issued by BHEL, shall form part of tender document.
- 10.0 In the event of any conflict between requirement of any clause of this specification/ documents /drawings /data sheets etc. or requirements of different codes/ standards specified/ contradictions between any two clauses of tender document, the same to be brought to the knowledge of BHEL by bidders in writing for clarification before due date of seeking clarification, otherwise, more stringent requirement as may be interpreted by BHEL shall prevail and shall be binding on you. Any typing error/missing pages/ other clerical errors in the tender documents, noticed by you must be pointed out before submission of offer, or else, BHEL's interpretation shall prevail & binding on you.
- 11.0 Unless specifically mentioned otherwise, bidder's quoted price shall deemed to be in compliance with tender including PBD.

- 12.0 Tender document containing above mentioned volumes shall be signed & stamped in all pages including this covering letter. Price bid shall be furnished in the specified format enclosed with the tender. Any additional copy, if required, may be taken by photocopying from the tender document given in the web.
- 13.0 **The Bidder has to satisfy the Pre-Qualifying Requirements stipulated for this Tender in order to be qualified. The Price Bids of only those bidders will be opened, who will qualify for the subject job on the basis of pre-qualification evaluation & Techno-Commercial bids etc. BHEL reserves the right to reject the bidders with unsatisfactory past performance in the execution of a contract. BHEL's decision in this regard shall be final & binding.**
- 14.0 While BHEL reserve the right to open the price bid of the offers in camera, the date & time to open the PRICE BID, tender opening shall be intimated to the bidders in case BHEL decides it to be 'Public opening' and in such a case, one authorised representative of the bidder shall be allowed to attend.
- 15.0 **Validity of the offer shall be for Six months from the due date of offer submission (including extension, if any) unless specified otherwise.**
- 16.0 **Firm prices are to be quoted in whole rupees, in the place meant for price or on the price schedule enclosed as applicable for the full scope of work given in tender. The rates quoted must be in figures and words as well (Prices quoted must be workable too for the job involved). Prices quoted by the bidders should be inclusive of all taxes and duties leviable by any Statutory Authority for this job as on the date of the tender opening (excluding GST & BOCW Cess).**
- 17.0 Price Bids shall be evaluated in the manner as prescribed in Price Schedule. However, Unit Rates shall also be furnished if applicable in the Price Schedule.
- 18.0 ***Bid should be free from correction, overwriting, using corrective fluid, etc. Any interlineation, cutting, erasure or overwriting shall be valid only if they are attested under full signature(s) of person(s) signing the bid else bid shall be liable for rejection.***
- 19.0 **Bidders are required to submit their BEST price as per tender Price Schedule format in e-procurement portal/platform in the form & manner as mentioned in tender.**
- 20.0 ***"BHEL shall be resorting to Reverse Auction (RA) (Guidelines as available on www.bhel.com) for this tender. RA shall be conducted among the techno-commercially qualified bidders.***
- Price bids of all techno-commercially qualified bidders shall be opened and same shall be considered for RA. In case any bidder(s) do(es) not participate in online Reverse Auction, their sealed envelope price bid along with applicable loading, if any, shall be considered for ranking."***
- 21.0 *Bidders are requested to note that the accepted / agreed tender terms (technical, commercial or on Reverse Auction) in their original offer can not be altered / withdrawn by their own during the processing of tender.*
- 22.0 **The Bidder along with its associate/collaborators/sub-contractors/sub-vendors/consultants/service providers shall strictly adhere to BHEL Fraud Prevention Policy displayed on BHEL website <http://www.bhel.com> and shall immediately bring to the notice of BHEL management about any fraud or suspected fraud as soon as it comes to their notice.**

23.0 **The offers of the bidders who are on the banned list as also the offer of the bidders, who engages the services of the banned firms, shall be rejected. The list of banned firms is available on BHEL web site www.bhel.com.**

l) Integrity commitment, performance of the contract and punitive action thereof:

a) Commitment by BHEL:

BHEL commits to take all measures necessary to prevent corruption in connection with the tender process and execution of the contract. BHEL will during the tender process treat all Bidder(s) in a transparent and fair manner, and with equity.

b) Commitment by Bidder/ Supplier/ Contractor:

b. i) The bidder/ supplier/ contractor commit to take all measures to prevent corruption and will not directly or indirectly influence any decision or benefit which he is not legally entitled to nor will act or omit in any manner which tantamount to an offence punishable under any provision of the Indian Penal Code, 1860 or any other law in force in India.

b. ii) The bidder/ supplier/ contractor will, when presenting his bid, disclose any and all payments he has made, and is committed to or intends to make to agents, brokers or any other intermediaries in connection with the award of the contract and shall adhere to relevant guidelines issued from time to time by Govt. of India/ BHEL.

b. iii) The bidder/ supplier/ contractor will perform/ execute the contract as per the contract terms & conditions and will not default without any reasonable cause, which causes loss of business/ money/ reputation, to BHEL.

If any bidder/ supplier/ contractor during pre-tendering/ tendering/ post tendering/ award/ execution/ post-execution stage includes in mal-practices, cheating, bribery, fraud or and other misconduct or formation of cartel so as to influence the bidding process or influence the price or acts or omits in any manner which tantamount to an offence punishable under any provision of the Indian Penal code, 1860 or any other law in force in India, then, action may be taken against such bidder/ supplier/ contractor as per extant guidelines of the company available on www.bhel.com and/ or under applicable legal provisions.

24.0 **The bidder shall submit documents in support of possession of 'Qualifying Requirements' duly self certified and stamped/ digitally signed (as applicable) by the authorized signatory, indexed and properly linked in the format for PQR. In case BHEL requires any other documents/proofs, these shall be submitted immediately.**

25.0 **The bidder may have to produce original document for verification if so decided by BHEL.**

26.0 Suspension of Business dealings with Suppliers/ Contractors: BHEL reserves the right to take action against contractors who fail to perform or indulge in malpractices, by suspending business dealings with them as detailed in Annexure-A.

27.0 **PREFERENCE TO MAKE IN INDIA:**

For this procurement, the local content to categorize a supplier as a Class-I local supplier/ Class-II local supplier/ Non-Local supplier and purchase preference to Class-I local supplier, is as defined in Public Procurement (Preference to Make in India), Order 2017 dated 04-06-2020 issued by DPIIT. In case of subsequent orders issued by the Nodal

Ministry, changing the definition of local content for the items of the NIT, the same shall be applicable even if issued after issue of this NIT, but before opening of Part-II bids against this NIT.

Duly filled & signed Form-1 (Format for local content), as applicable, to be submitted by bidders along with their techno-commercial offer.

- 28.0 MSE suppliers can avail the intended benefits in respect of the procurements related to the Goods and Services only (Definition of Goods and Services as enumerated by Govt. of India vide Office Memorandum F. No. 21(8)/2011-MA dtd. 09/11/2016 office of AS & DC, MSME) if they submit along with the offer, attested copies of either Udyam Registration Certificate or EM II certificate having deemed validity (five years from the date of issue of acknowledgement in EM II) or valid NSIC certificate or Udyog Aadhar Memorandum (UAM) & Acknowledgement or EM II certificate along with attested copy of a CA certificate (Format enclosed at Annexure – B where deemed validity of EM II certificate of five years has expired) applicable for the relevant financial year (latest audited). Date to be reckoned for determining the deemed validity will be the date of bid opening (Part 1 in case of two part bid). Non submission of such documents will lead to consideration of their bid at par with other bidders. No benefit shall be applicable for this enquiry if any deficiency in the above required documents are not submitted before price bid opening. If the tender is to be submitted through e-procurement portal, then the above required documents are to be uploaded on the portal. Documents should be notarized or attested by a Gazetted officer.

Any Bidder falling under MSME category, shall furnish the following details & submit documentary evidence/Govt. Certificate etc. in support of the same along with their techno-commercial offer: -

Type under MSME	SC/ST owned	Women owned	Others (excluding SC/ ST & Women Owned)
Micro			
Small			
Medium			

Note: - If the bidder does not furnish the above, offer shall be processed construing that the bidder is not falling under MSME category.

29.0 Compliance to Restrictions under Rule 144 (xi) of GFR 2017

- I. Any bidder from a country which shares a land border with India will be eligible to bid in this tender only if the bidder is registered with the Competent Authority. The Competent Authority for the purpose of this Clause shall be the Registration Committee constituted by the Department for Promotion of Industry and Internal Trade (DPIIT).
- II. "Bidder" (including the term 'tenderer', 'consultant' or 'service provider' in certain contexts) means any person or firm or company, including any member of a consortium or joint venture (that is an association of several persons, or firms or companies), every artificial juridical person not falling in any of the descriptions of bidders stated hereinbefore, including any agency branch or office controlled by such person, participating in a procurement process.
- III. "Bidder from a country which shares a land border with India" for the purpose of this Clause means: -
 - a. An entity incorporated established or registered in such a country; or
 - b. A subsidiary of an entity incorporated established or registered in such a country; or
 - c. An entity substantially controlled through entities incorporated, established or registered in such a country; or

- d. An entity whose beneficial owner is situated in such a country; or
 - e. An Indian (or other) agent of such an entity; or
 - f. A natural person who is a citizen of such a country; or
 - g. A consortium or joint venture where any member of the consortium or joint venture falls under any of the above
- IV. The beneficial owner for the purpose of (III) above will be as under:
1. In case of a company or Limited Liability Partnership, the beneficial owner is the natural person(s), who, whether acting alone or together or through one or more juridical person, has a controlling ownership interest or who exercises control through other means.
- Explanation
- a. "Controlling ownership interest" means ownership of or entitlement to more than twenty-five per cent of shares or capital or profits of the company.
 - b. "Control" shall include the right to appoint majority of the directors or to control the management or policy decisions including by virtue of their shareholding or management rights or shareholders agreements or voting agreements.
2. In case of a partnership firm, the beneficial owner is the natural person(s) who, whether acting alone or together, or through one or more juridical person, has ownership of entitlement to more than fifteen percent of capital or profits of the partnership.
 3. In case of an unincorporated association or body of individuals, the beneficial owner is the natural person(s), who, whether acting alone or together, or through one or more juridical person has ownership of or entitlement to more than fifteen percent of the property or capital or profits of the such association or body of individuals.
 4. Where no natural person is identified under (1) or (2) or (3) above, the beneficial owner is the relevant natural person who holds the position of senior managing official;
 5. In case of a trust, the identification of beneficial owner(s) shall include identification of the author of the trust, the trustee, the beneficiaries with fifteen percent or more interest in the trust and any other natural person exercising ultimate effective control over the trust through a chain of control or ownership.
- V. An Agent is a person employed to do any act for another, or to represent another in dealings with third person.
- VI. The successful bidder shall not be allowed to sub-contract works to any contractor from a country which shares a land border with India unless such contractor is registered with the Competent Authority.

Note:

- (i) The bidder shall provide undertaking for their compliance to this Clause, in the Format provided in Form-2.
- (ii) Registration of the bidder with Competent Authority should be valid at the time of submission as well as acceptance of the bids.

30.0 GeMAR and PTS ID: GEM/GARPTS/23112022/ZUK9S8D3N7VS

31.0 The Bidder declares that they will not enter into any illegal or undisclosed agreement or understanding, whether formal or informal with other Bidder(s). This applies in particular to prices, specifications, certifications, subsidiary contracts, submission or non-submission of bids or any other actions to restrict competitiveness or to introduce cartelization in the bidding process.

In case, the Bidder is found having indulged in above activities, suitable action shall be taken by BHEL as per extant policies/ guidelines.

Bidder shall submit duly filled & signed Annexure-VII along with their techno-commercial offer.

32.0 In the course of evaluation, if more than one bidder happens to occupy L-1 status, effective L-1 will be decided by soliciting discounts from the respective L-1 bidders.

In case more than one bidder happens to occupy the L-1 status even after soliciting discounts, the L-1 bidder shall be decided by a toss / draw of lots, in the presence of the respective L-1 bidder(s) or their representative(s).

Ranking will be done accordingly. BHEL's decision in such situations shall be final and binding.

33.0 Order of Precedence: In the event of any ambiguity or conflict between the Tender Documents, the order of precedence shall be in the order below: -

- i) Amendments/Clarifications/Corrigenda/Errata/Tender change notice (TCN) etc. issued in respect of the tender documents by BHEL
- ii) Notice Inviting Tender (NIT)
- iii) Price Schedule
- iv) Scope of work & other details - Annexure-I, Annexure-BOCW, Annexure-SAS-I, Annexure-II, Annexure-III, Annexure for HSE & OCP and Special note to bidders.
- v) SPECIFIC TERMS AND CONDITIONS FOR SERVICES JOBS
- vi) GENERAL & SPECIAL CONDITIONS OF CONTRACT FOR SERVICES JOB

All the bidders are requested to note that all the errata / technical clarifications / corrigendum / extension etc. shall be published THROUGH E-PROCUREMENT PORTAL <https://eprocurebhel.co.in> and in website www.bhel.com & <http://eprocure.gov.in> . As such, all the bidders are requested to be in continuous touch with these websites.

for BHARAT HEAVY ELECTRICALS LTD.

MANAGER (PURCHASE)

Agency	Contact details	
BHEL, PSER, Kolkata	Address	BHARAT HEAVY ELECTRICALS LIMITED, POWER SECTOR – EASTERN REGION 2ND FLOOR, BLOCK-DJ, PLOT- 9/1, SECTOR, SALT LAKE CITY, KOLKATA – 700 091
	Phone no.	033-23398261, 23398223, 23398220, 23211690
	FAX no.	033-23211960
	E-mail ID	anima@bhel.in , anupriya.mundu@bhel.in , a_sarkar@bhel.in
NIC E- PROCUREMENT PORTAL	<p>For E-PROCUREMENT ASSISTANCE & TRAINING, NIC HELPDESK CONTACTS AS PER FOLLOWING: -</p> <p>For any technical related queries please call at 24 x 7 Help Desk Number 0120-4001 002 0120-4200 462 0120-4001 005 0120-6277 787</p> <p>Email Support Address: A) For any Issues or Clarifications relating to the published tenders, bidders are requested to contact the respective Tender Inviting Authority</p> <p>Technical - support-eproc@nic.in</p>	

ANNEXURE - IV

FORMAT FOR NO DEVIATION CERTIFICATE
(To be submitted in the bidder's letter head)

To,
Bharat Heavy Electricals Limited,
POWER SECTOR – EASTERN REGION
2nd FLOOR, Block-DJ, Plot- 9/1, SECTOR II
SALT LAKE CITY, KOLKATA – 700 091
FAX – 033-2321-1960

Job: “OVERHAULING OF TURBINE (HP & LP), GENERATOR AND AUXILIARY WORKS AT UNIT-3, 250 MW (KWU DESIGN), BUDGE BUDGE, CESC, WEST BENGAL”.

E-Tender No.: PSER:PUR:CESC-S501:22 (ENQ:22:PP:0015:PUR:91) Date 25/11/2022.

Dear Sir/Madam,

With reference to above, this is to confirm that as per tender conditions, we have visited site before submission of our offer and noted the job content & site conditions etc. We also confirm that we have not changed/modified the tender documents as appeared in the websites and in case of observance at any stage, it shall be treated as null and void.

We hereby confirm that we have not taken any deviation from tender clauses together with other references as enumerated in the above referred NIT *and confirm our acceptance to reverse auctioning process* and we hereby convey our unqualified acceptance to all terms and conditions as stipulated in the tender and NIT.

In the event of observance of any deviation in any part of our offer at a later date whether implicit or explicit, the deviations shall stand null & void.

We confirm to have submitted offer strictly in accordance with tender instructions.

Thanking you,

Yours faithfully,

(Signature, date & seal of authorized
representative of the contractor)

ANNEXURE - V**PRE – QUALIFICATION CRITERIA**

Job: “OVERHAULING OF TURBINE (HP & LP), GENERATOR AND AUXILIARY WORKS AT UNIT-3, 250 MW (KWU DESIGN), BUDGE BUDGE, CESC, WEST BENGAL”.

E-Tender No.: PSER:PUR:CESC-S501:22 (ENQ:22:PP:0015:PUR:91) Date 25/11/2022.

SL NO	CRITERIA
	PRE-QUALIFICATION CRITERIA
	PRE-QUALIFICATION CRITERIA- FINANCIAL
1.0 (a)	BIDDER SHOULD HAVE AVERAGE ANNUAL TURNOVER OF MINIMUM Rs 25.01 LAKHS DURING LAST 3 (THREE) FINANCIAL YEARS, ENDING ON 31-03-2022 AND SHOULD HAVE POSITIVE NET WORTH AS ON LATEST AUDITED ACCOUNTS AS SUBMITTED FOR PARA 1(c).
(b)	BIDDER MUST HAVE EARNED PROFIT IN ANY ONE OF THE LAST THREE FINANCIAL YEARS ENDING ON 31-03-2022. AUDITED BALANCE SHEET AND PROFIT & LOSS ACCOUNT OF THE COMPANY FOR LAST 3 (THREE) FINANCIAL YEARS, ENDING ON 31-03-2022 NEED TO BE SUBMITTED IN SUPPORT OF ABOVE.
(c)	IN CASE AUDITED BALANCE SHEET AND PROFIT & LOSS ACCOUNT HAS NOT BEEN SUBMITTED FOR ALL THREE YEARS INDICATED ABOVE THEN APPLICABLE FINANCIAL AUDITED STATEMENTS SUBMITTED BY THE BIDDER AGAINST THE REQUISITE THREE YEARS WILL BE AVERAGED FOR THREE YEARS.
(d)	IF FINANCIAL STATEMENTS ARE NOT REQUIRED TO BE AUDITED STATUTORILY, THEN INSTEAD OF AUDITED FINANCIAL STATEMENTS, FINANCIAL STATEMENTS ARE REQUIRED TO BE CERTIFIED BY CHARTERED ACCOUNTANT.
	PRE-QUALIFICATION CRITERIA -TECHNICAL
2.0	BIDDER SHOULD HAVE EXECUTED AT LEAST ONE JOB OF “ERECTION & COMMISSIONING OF STEAM TURBINE, GENERATOR & AUX. WORKS” OR “OVERHAULING OF STEAM TURBINE, GENERATOR & AUX. WORKS” OF AN UNIT OF RATING 190 MW OR ABOVE (KWU DESIGN) IN ANY UTILITY/ INDUSTRIAL PROJECT IN LAST 7 (SEVEN) YEARS, ENDING ON LATEST DUE DATE OF SUBMISSION OF OFFER. RELEVANT SUPPORTING DOCUMENTS FROM PURCHASER / END USER SHALL BE SUBMITTED.
	NOTE FOR SL NO 2.0 ABOVE
	THE WORD EXECUTED MEANS: THE WORK SHALL HAVE BEEN COMPLETED UPTO SYNCHRONISATION (FIRST SYNCHRONIZATION DATE SHALL BE CONSIDERED FOR EVALUATION) EVEN IF THE CONTRACT HAS NOT BEEN COMPLETED OR CLOSED.
3.0	BIDDER SHOULD HAVE VALID PAN. RELEVANT SUPPORTING DOCUMENTS SHALL BE SUBMITTED.
4.0	NO CONSORTIUM / JV BIDDING IS ALLOWED FOR THIS TENDER.
5.0	CONSIDERATION OF OFFER WILL BE SUBJECT TO CUSTOMER'S APPROVAL OF BIDDER.
6.0	BIDDER MUST NOT BE UNDER BANKRUPTCY CODE PROCEEDINGS (IBC) BY NCLT OR UNDER LIQUIDATION / BIFR, WHICH WILL RENDER HIM INELIGIBLE FOR PARTICIPATION IN THIS TENDER, AND SHALL SUBMIT UNDERTAKING TO THIS EFFECT.
Note	AFTER SATISFACTORY FULFILLMENT OF ALL THE ABOVE CRITERIA, OFFER SHALL BE CONSIDERED FOR FURTHER EVALUATION AS PER NIT AND ALL OTHER TERMS OF THE TENDER.

GENERAL INFORMATION:

VENDOR SHOULD FURNISH INFORMATION REGARDING PROJECTS IN HAND, DETAILS OF CURRENT LITIGATION AND ARBITRATION CASES, ORDERS REGARDING EXCLUSION/EXPULSION OR BLACK LISTING, IF ANY.

CORRIGENDUM/EXTENSION (IF ANY) OF THIS TENDER WILL BE PUBLISHED IN WEBSITES.

INTERESTED BIDDERS MEETING THE ABOVE QUALIFYING REQUIREMENTS MAY DOWNLOAD TENDER DOCUMENTS FROM AFORESAID WEBSITE(S).

i)	DOWNLOAD OF TENDER DOCUMENT STARTS	25/11/2022
ii)	TENDER DOWNLOAD CLOSING ON	28/11/2022 AT 14:00 HRS. IST
iii)	LAST DATE OF SEEKING CLARIFICATIONS	28/11/2022 UP TO 11:00 HRS. IST
iv)	PRE-BID DISCUSSION (IF REQUIRED) ON	N.A.
v)	LAST DATE OF SUBMISSION OF OFFER	28/11/2022 UP TO 14:00 HRS. IST
vi)	DATE OF TECHNO-COMMERCIAL BID OPENING	28/11/2022 AT 16:30 HRS. IST

BHEL RESERVE THE RIGHT TO ACCEPT/REJECT ANY OR ALL THE BIDS WITHOUT ASSIGNING ANY REASON THEREOF.

NOTE: PRE-BID DISCUSSION, IF TAKE PLACE, SHALL FORM PART OF THE TENDER DOCUMENT. NO CLARIFICATIONS/QUIRIES FROM THE TENDERERS AFTER **28/11/2022 (UP TO 11:00 HRS. IST) OR AFTER PRE-BID DISCUSSION (IF TAKES PLACE) SHALL BE ENTERTAINED BY BHEL.**

ENCLOSURES: -

- i) SCOPE OF WORK, TAXES AND DUTIES & OTHER DETAILS: (ANNEXURE-I: 10 PAGES)
- ii) *SPECIFIC CLAUSE WITH RESPECT TO BOCW ACT & CESS ACT: (ANNEXURE-BOCW: 02 PAGES)*
- iii) ESSENTIAL CONDITIONS TO BE FULFILLED BY SUCCESSFUL BIDDER (ANNEXURE-SAS-I: 01 PAGE)
- iv) TENTATIVE LIST OF T & P (ANNEXURE-II: 04 PAGES)
- v) LIST OF CONSUMABLES TO BE ARRANGED BY THE CONTRACTOR IN ADDITION TO THE NORMAL CONSUMABLES (ANNEXURE-III: 01 PAGE)
- vi) SPECIAL NOTE TO BIDDERS: 02 PAGES
- vii) ANNEXURE FOR HSE PLAN VIDE DOC. NO. HSEP:14-ER (REV.: 01 DTD. 08/05/20- 170 PAGES) WITH OCP DOC. NO. HSEOCP: 61 (REV. NO.: 01 DTD. 01/06/20 -13 PAGES) & HSEOSP: 61A (REV. NO.: 00 DTD. 27/04/20 -03 PAGES)
- viii) GENERAL & SPECIAL CONDITIONS OF CONTRACT FOR SERVICES JOB (24 PAGES)
- ix) SPECIFIC TERMS AND CONDITIONS FOR SERVICES JOB (14 PAGES)
- x) NO DEVIATION CERTIFICATE AS PER PRESCRIBED FORMAT (ANNEXURE-IV)
- xi) PRE-QUALIFICATION CRITERIA (ANNEXURE-V)
- xii) DECLARATION OF THE BIDDERS (ANNEXURE-VI)
- xiii) DECLARATION OF RELATED FIRMS AND THEIR AREA OF ACTIVITIES (ANNEXURE-VII)
- xiv) PRICE SCHEDULE
- xv) *GENERAL TERMS & CONDITIONS OF REVERSE AUCTION (PART – D)*
- xvi) *FORMAT FOR BANK GUARANTEE FOR PERFORMANCE SECURITY*
- xvii) *FORMAT FOR PROFORMA OF BANK GUARANTEE (in lieu of SECURITY DEPOSIT)*
- xviii) *RTGS FORMAT (REAL TIME GROSS SETTLEMENT)*
- xix) *SUSPENSION OF BUSINESS DEALING WITH SUPPLIERS/CONTRACTORS - ANNEXURE-A*
- xx) *FORMAT FOR CERTIFICATE BY CHARTERED ACCOUNTANT ON LETTER HEAD - ANNEXURE-B*
- xxi) *BANKRUPTCY/ LIQUIDATION UNDERTAKING-ANNEXURE-C*
- xxii) *FORMAT FOR DECLARATION FOR RELATION IN BHEL*
- xxiii) *FORMAT FOR SEEKING CLARIFICATION*
- xxiv) *FORMAT FOR DETAILS OF BIDDER*
- xxv) *FORM-1 (FORMAT FOR LOCAL CONTENT)*
- xxvi) *FORM-2*
- xxvii) *RTGS DETAILS OF BHEL-PSER FOR EFT BY BIDDER/CONTRACTOR*

ALL THE PAGES OF NIT SHALL BE DULY SIGNED BY THE BIDDER WHILE SUBMITTING THE OFFER.

For & on behalf of
BHARAT HEAVY ELECTRICAL LIMITED

MANAGER (PURCHASE)

PARTICULARS OF THE TENDER

- A) E-TENDER NUMBER : **PSER:PUR:CESC-S501:22 (ENQ:22:PP:0015:PUR:91)**
Date 25/11/2022.
- B) WORK : **“OVERHAULING OF TURBINE (HP & LP), GENERATOR AND AUXILIARY WORKS AT UNIT-3, 250 MW (KWU DESIGN), BUDGE BUDGE, CESC, WEST BENGAL”.**
- C) TENDER SUBMISSION DUE DATE : **ON 28/11/2022 UP TO 14:00 HRS. IST**
- D) TECHNICAL BID OPENING DATE : **ON 28/11/2022 AT 16:30 HRS. IST**
- E) PRICE BID OPENING :
- F) VALIDITY OF OFFER : Six months from the due date of offer submission
(Including extension, if any)
- G) MOBILIZATION TIME : **As per Annexure-I**
- H) COMPLETION PERIOD : **As per Annexure-I**
- I) TARGET COMPLETION DATE :

J) The vendors should furnish the following documents for our scrutiny along with papers for pre-qualification for qualifying for price bid opening.

- 1) Credential / Experience certificates in line with Pre-Q & requirements in line with tender specifications
- 2) PAN NO & Photo Copy of PAN CARD.
- 3) Photo Copy of GSTN Registration Certificate.
- 4) Latest Banker's certificate for financial soundness.
- 5) Balance sheets & P&L Accounts for the preceding three years
- 6) Organizational chart
- 7) Relevant list of T&P held by the vendor earmarked for the tendered job
- 8) List of concurrent contracts held by the Contractor.

Particulars of Tender (Continued)

Facilities to be provided to contractors as described below: -

All T&P required / recommended for the work against this tender shall have to be mobilized by the contractor fully at their expense within the quoted price.

Any special T&P i.e. T&P made available by the manufacture of the equipment to the customer can be made available to the contractor free of charges subject to availability at site.

Any consumables required / recommended for the work against this tender shall have to be mobilized by the contractor fully at their expenses within the quoted price.

Regarding other facilities for the contractors the following table clarifies adequately. Vendors are expected to quote considering these without any deviations from the provisions of “Notice Inviting Tender”.

Deviated offers are liable for rejection of price bid opening

a)	Water	Free of Charges
b)	Power	Free of Charges
c)	Storage Space	Free of Charges
d)	Covered Space	Free of Charges
e)	Uncovered Space	Free of Charges
f)	E.O.T. Crane	Free of Charges
g)	Operators for the above	Cannot be provided
h)	Residential accommodation	Cannot be provided
i)	Compressed air	Free of Charges
j)	Work shop facilities	Cannot be provided

k)	i) Mobile Crane/Hydra for heavy materials, if available	Cannot be provided
	ii) Operator for K (i)	Cannot be provided
	iii) Fuel for K (i)	Cannot be provided
l)	Other material handling equipment	Cannot be provided
m)	Trailor	Cannot be provided
n)	Sleepers	Cannot be provided
o)	Tarpaulins	Cannot be provided
p)	Scaffolding materials	Cannot be provided

No advance is payable to the contractors for mobilizing the site. Any payment can be made only against running bills as per payment terms.

For & on behalf of
BHARAT HEAVY ELECTRICALS LIMITED

MANAGER (PURCHASE)

ANNEXURE-VI

DECLARATION OF THE BIDDERS

Job: "OVERHAULING OF TURBINE (HP & LP), GENERATOR AND AUXILIARY WORKS AT UNIT-3, 250 MW (KWU DESIGN), BUDGE BUDGE, CESC, WEST BENGAL".

01. I,hereby certify that all the information and data furnished by me with regard to this **E-Tender No. PSER:PUR:CESC-S501:22 (ENQ:22:PP:0015:PUR:91) Date 25/11/2022** are true and complete to the best of my knowledge.
02. I have gone through the tender specifications, scope of work, terms and conditions mentioned in Annexure as well as General and Special conditions of contract and various stipulations in detail and agree to abide by them and comply with the requirements and intent of specifications.
03. I also certify that there have been no deviations from the tender requirements in the bid submitted against this tender.
04. I further certify that I am duly authorized representative of the under mentioned tenderer and hold a valid power of attorney to this effect, a copy of which is enclosed.

Signature:

Name :

Date :

Designation :

Seal :

Tenderers Name and address

ANNEXURE-VII
DECLARATION

Date: -----

Job: "OVERHAULING OF TURBINE (HP & LP), GENERATOR AND AUXILIARY WORKS AT UNIT-3, 250 MW (KWU DESIGN), BUDGE BUDGE, CESC, WEST BENGAL".

E-Tender No.: PSER:PUR:CESC-S501:22 (ENQ:22:PP:0015:PUR:91) Date 25/11/2022.

To: -----
Address: ----- BHEL, -----

Email: -----

Sub: **Details of related firms and their area of activities**

Dear Sir/Madam,

Please find below details of firms owned by our family members that are doing business/registered for same item with BHEL, -----(NA, if not applicable)

1	Material Category/ Work Description	
	Name of Firm	
	Address of Firm	
	Nature of Business	
	Name of Family Member	
	Relationship	
2	Material Category/ Work Description	
	Name of Firm	
	Address of Firm	
	Nature of Business	
	Name of Family Member	
	Relationship	
...		

Note: I certify that the above information is true and I agree for penal action from BHEL in case any of the above information furnished is found to be false.

Regards,

(-----)

From: M/s-----
Supplier Code: -----
Address: -----

PART-D:
General Terms & Conditions of Reverse Auction

Against this enquiry for the subject item/ system with detailed scope of supply/service as per tender specifications, BHEL *shall be resorting* to "REVERSE AUCTION PROCEDURE" i.e., ON LINE BIDDING (THROUGH A SERVICE PROVIDER). The philosophy followed for reverse auction shall be English Reverse (No ties).

1. For the proposed reverse auction, technically and commercially acceptable bidders only shall be eligible to participate.
2. *Price bids of all techno-commercially qualified bidders shall be opened and same shall be considered for RA.*
3. BHEL will engage the services of a service provider who will provide all necessary training and assistance before commencement of on line bidding on internet.
4. In case of reverse auction, BHEL will inform the bidders the details of Service Provider to enable them to contact & get trained for participation in the reverse auction.
5. Business rules like event date, time, bid decrement, extension etc. also will be communicated through service provider for compliance.
6. Bidders have to fax *le-mail* the Compliance form (annexure III) before start of Reverse auction. Without this, the bidder will not be eligible to participate in the event.
7. In line with the NIT terms, BHEL will provide the calculation sheet (e.g., EXCEL sheet) which will help to arrive at "Total Cost to BHEL" which is inclusive of all cost elements in line with terms & conditions of the tender for each of the bidder to enable them to fill-in the price and keep it ready for keying in during the Auction.
8. Reverse auction will be conducted on scheduled date & time.
9. At the end of Reverse Auction event, the lowest bidder value will be known on auction portal.
10. The lowest bidder has to fax/e-mail the duly signed and filled-in prescribed format for price breakup including that of line items, if required, (Annexure VI) as provided on case-to-case basis to Service provider within two working days of Auction without fail.
11. *Bidders shall be required to read the "Terms and Conditions" section of the auctions site of Service provider, using the Login IDs and passwords given to them by the service provider before reverse auction event. Bidders should acquaint themselves of the "Business Rules of Reverse Auction", which will be communicated before the Reverse Auction.*
12. The Bidder shall not divulge either his Bids or any other exclusive details of BHEL to any other party. If the Bidder or any of his representatives are found to be involved in Price manipulation/ cartel formation of any kind, directly or indirectly by communicating with other bidders, action *as per extant BHEL guidelines for suspension of business dealings (as available on www.bhel.com)*, shall be initiated by BHEL and the results of the RA scrapped/ aborted.
13. Reverse Auction will be conducted if two or more bidders are techno-commercially qualified. In case of two or three qualified bidders, there shall be no elimination of H1 bidder (whose quote is highest in sealed envelope price bid). In case of four qualified bidders, the H1 bidder shall be eliminated whereas in case of five qualified bidders, H1 & H2 bidders shall be eliminated. However, in case of six or *more qualified bidders are available, RA would be conducted amongst first 50% of the bidders arranged in the order of prices from lowest to highest. Number of bidders eligible for participating in RA would be rounded off to next higher integer value if number of qualified bidders is odd (e.g. if 7 bids are qualified, then RA will be conducted amongst lowest four bidders). However, there will be no elimination of qualified bidders who are MSE or qualifying under PPP-MII, Order 2017, irrespective of the number of bidders qualifying techno-commercially.*

In case of multiple H1 bidders, all H1 bidders (excluding MSEs and bidders qualifying under PPP-MII, Order 2017) shall be removed provided minimum two bidders remain in fray, else no H1 removal.

SCOPE OF WORKJOB DESCRIPTION: OVERHAULING OF TURBINE (HP & LP), GENERATOR AND AUXILIARY WORKS OF UNIT-3, 250 MW (KWU DESIGN) AT CESC-BUDGE BUDGE, WEST BENGAL

Job Duration: 21 Days from Off-Bar to BG in. Start of work shall be certified by BHEL site engineer and shall commence from date of Off-Bar or within 3 days from date of intimation by BHEL, whichever is later.

Mobilisation time: Vendor shall start mobilisation within 3 days from date of intimation by BHEL

The scope under this specification is not exhaustive but indicative only. However, any activity covered under the normal course of overhauling job shall be deemed to be within the scope. The scope shall also include, manpower assistance during trim balancing as may be required including post overhauling vibration signature analysis. Time is the essence of this contract. Hence contractor must mobilize site with adequate manpower for round the clock 12 hours shifts work during the entire duration. Workmen will not be allowed to work more than 12 hrs a day. Also adequate T&P, Consumables and inspection/measuring and monitoring devices are to be mobilized at site for two shift operations to avoid any hold up during execution of the work. Post overhauling and synchronization of the unit, observation for 72 hrs at stable load and attending all works to rectify defects if any, is included within the scope of work. Prior to mobilization of site list of work men shift wise with the concerned work area supervisor shall be finalized in BHEL-PSER, HQ.

In case any part of the job is not required to be carried out, a deduction will be effected as per percentage shown against those items.

NOTE:

- 1) INDUCTION HEATING MACHINE ALONG WITH OPERATOR WILL BE ARRANGED BY BHEL FOR HP, IP TURBINE OPENING. MANPOWER ASSISTANCE DURING PARTING PLANE BOLT/STUD OPENING AND CLOSING WILL BE PROVIDED BY VENDOR. VENDOR TO ARRANGE INDUCTION/ GAS HEATING FOR BREECH NUT OPENING AND CLOSING.
- 2) **ALUMINA BLASTING:** ALUMINA BLASTING INCLUDING ARRANGEMENT OF COMPRESSED AIR & ALL OTHER MACHINERIES REQUIRED FOR ALUMINA BLASTING ARE IN VENDOR'S SCOPE. HOWEVER, COMPRESSED AIR IF REQUIRED FOR OTHER THAN ALUMINA BLASTING WILL BE PROVIDED CUTOMER FROM PLANT SERVICE LINE.

	TOTAL	(100.00%)
A	TURBINE AND AUXILIARY SYSTEMS	(62.00%)
A.1	HPT MODULE OVERHAULING	(15.00%)
1	Removal of insulation and all connecting pipes of HP module, which will obstruct during lifting of the HP Module. Dismantling of casing thermocouples. Disposal of insulation and scrap material to designated location including arrangement of its transportation.	0.25%
2	Checking of all the clearances (roll check, bump check, entering check, horn drop check etc.).Initial/final measurement of reference readings of HP module. Coupled run out to be checked.	0.75%
3	Removal of breech nut (02 nos.) and CRH pipe lines by induction heating/gas heating & other related pipelines. Locking of pipe lines as required. Cutting of breech nut as required, UT of MS pipe, subsequent welding and SR of MS pipe joint after re-welding according to BHEL specified welding procedure, necessary arrangement of gas is included in vendor scope within quoted price.	1.50%

5	Locking of turbine shaft with outer casing by locking arrangement. Removal of both bearing no 01 and 02 bottom halves bearings.	0.50%
6	Lifting of complete HP module from pedestal and placing on fixture.	0.50%
7	Tilting of complete module and placing in vertical position.	0.25%
8	Dismantling of both end glands including removal of sealing segments. Locking of rotor with respect to inner casing and outer casing both axially and radially.	0.50%
9	Loosening of threaded ring from barrel and removal of the same.	0.25%
10	Removal of rotor with inner casing from barrel with the help of attachment etc. and placing of the same on fixture in horizontal position for inspection as required.	0.25%
11	Removal of top half of inner casing after loosening of parting plane studs. Inspection of rotor and stator blades, fins, etc. Assistance during loosening of inner casing parting plane nut by Induction heating equipment.	0.50%
12	Removals of rotor from bottom half. Removal of sealing segments from both half of HP inner casing.	0.25%
13	Measurement of parting plane stud length and replacement if required. Testing of spring support on sealing segments, sealing strips etc. and replacement as required.	0.50%
14	Placement of top half casing on bottom half casing and aligning the alignment shaft.	0.25%
15	Insertion of inner casing in outer barrel and aligning the inner casing in casing inlet section and fitting in with the fitted keys. Replacement of keys as required.	0.50%
16	Facial and free run-out measurement. Correction of face as required to get desired swing values. Arrangement of annular surface plate (considering spigot) for coupling face correction is in vendor's scope.	0.50%
17	Thorough inspection of rotor, casing & gland seals. Minor repair of rotor and inner casing blade shifting.	0.25%
18	Measurement of axial and radial clearances (flow path) and corrections to be made if required.	0.25%
19	Ovality checking of HP inner casing. Correction of shroud parting plane gap. Assistance during heat tightening by induction heating equipment.	0.50%
20	Alumina cleaning of the rotor and HP inner casing (top and bottom) blades, studs, sealing segments etc. Supply of alumina (80 grit size), blasting nozzles/ other arrangements, enclosure including covering by tarpaulins and proper illumination / ventilation of enclosure is included in vendor's scope of work.	0.50%
21	Re-finishing of rotor gland area & sealing segments , subsequent machining of the same at site, as may be required. Arrangement of machining fixture included in vendor's scope. Replacement of new gland ring/ segments as may be required.	1.25%
22	Measurement of 'U' seal ring compression. Replacement of 'U' seal rings as may be required including to & fro transportation to BHEL-VARANASI/ HARIDWAR.	0.50%
23	Checking of axial and radial clearances for sealing segments after insertion of the same and placement of the rotor. Dressing of fins to be done wherever damaged.	0.25%
24	Inspection of HPT internals & fasteners and carrying out cleaning, repair, replacement of components etc. and DPT as required.	0.50%
25	Turbine shaft insertion in bottom half for final assembly and top half to be placed in position. Tightening of the studs with Induction Heating device.	0.50%
26	Minor dressing/ hand machining of casing & rotor inter stage fins as may be required to maintain design radial clearance.	0.50%
27	Roll check and bump check of assembled inner casing. Measurement of axial reference.	0.50%
28	Assistance during slow speed balancing of HP rotor.	0.25%
29	Locking of inner casing with rotor for inserting in casing. Inner casing to be inserted in the inlet section after fitting of the internals etc.	0.25%

30	Assembly of front gland sealing segments, glands etc. with new or re-finned ones & subsequent machining of sealing segments. Hand machining of sealing segment to maintain height is included in vendor scope.	0.50%
31	Assembled module to be put back on the pedestal.	0.25%
32	Final connections of all pipe lines, breech nuts, welding of gland steam pipe lines and stress relieving, UT, X-ray of joints including steam gland pipes as applicable. Arrangement of welding rods, filler rod is included in vendor's scope. Drilling & Reaming of Breech nut pin if required.	1.00%
A.2	LPT MODULE OVERHAULING	(15.00%)
1	Loosening of L P outer casing parting plane joints bolts and removal of LP outer shell, dismantling of both end cones.	0.25%
2	Covering of condenser tubes from inside the condenser and prepare platform of LP casing joints plane. Jacking LP casing and necessary arrangement of platform. Arrangement of pipe & clamp cover is included in vendor's scope of work. Condenser spring locking and unlocking is in vendor's scope.	0.25%
3	Loosening of joints plane bolts to remove LP inner-outer casing and LP inner- inner casing by Induction heating equipment. Assistance during loosening of parting plane studs by Induction heating equipment	0.25%
4	Record all necessary readings, roll check during dismantling of casing.	0.25%
5	Inspection of LP turbine internals and record radial and axial clearances of fixed and moving blades and rotor gland seals. Removing of LP rotor and placing it on rotor support.	0.25%
6	Thorough cleaning of bottom and top casing halves and the rotor. Alumina blasting cleaning of LP rotor, LP Rotor moving /LP stationary blades and top inner-inner, inner-outer casing etc. Supply of alumina (80 grit size), blasting nozzles/ other arrangements, enclosure including covering by tarpaulins and proper illumination / ventilation of enclosure is included in vendor's scope of work.	0.75%
7	Thorough inspection of rotor and casing. D P test of rotor, blades and casing in the suspected area /zone.	0.25%
8	Replacement / repair of damaged sealing rings of rotor and cylinder. Inspection and replacement of inter-stage fins as possible of LP Rotor, as per requirement.	0.25%
9	Free & facial run-out measurement at both end of LP rotor and IP rotor (LP end) as may be required. Correction of face to achieve desired swing value. Arrangement of annular surface plate (considering spigot) for coupling face correction is in vendor's scope. Surface finish of surface plate should be 04 micron or less and it has circular hole inside to accommodate spigot.	1.00%
10	Visual inspection and DPT of steam inlet bellows, all LP extractions bellows, LP front and rear expansion bellows of the gland box. Removal of necessary compensator protection pipes, repair of bellows as per requirement. Arrangement DPT kit along with operator, high pressure welder, filler and welding rods etc. is under vendor's scope. Replacement of two no. of extraction bellows included in vendor's scope	1.25%
11	Ovality checking of LP inner-inner and inner outer casing, correction by grinding as per requirement. Assistance during Inner-inner casing parting plane stud and cap nuts tightening by Induction heating equipment. Deformation and gap checking of inner-inner and inner-outer casing parting plane and correction by welding as per BHEL WPS & post welding treatment is included in vendor's scope of work.	1.00%
12	Placement of LP rotor inside bottom casing.	0.25%
13	Boxing-up of LP inner- inner and inner- outer casing. Tightening of studs by Induction heating equipment. Assistance during tightening of parting plane studs by Induction heating equipment	0.75%
14	Roll check of LP rotor. Correction of internal radial and axial clearances	0.25%
15	Boxing- up of LP outer shell.	0.50%

16	Setting of gland boxes as per recommended clearances. Removal and replacement of gland segments and springs, re-finishing and hand machining of gland seal segments as required. Cleaning of LP front and rear seal segments by alumina blasting. Checking and setting of clearances of jack bolts after 24 hours of synchronization.	0.75%
17	Inspection of safety diaphragms and replacement if required.	0.25%
18	Inspection of all balancing weight of LP rotor of both end, removal, assembly and replacement (if found damaged) of high density balancing weight. Hot-well cleaning after box-up of LPC. Opening and closing of Hot-well manhole.	0.25%
19	Removal of LP last two stage blades (3L & 3R, 2L&2R as per tech cir. No X-68), cleaning of blades at root, assistance during NFT, matching as required to get improved NFT values, assembly of blade with technological pieces, removal of blades, final assembly of blades with clamping pieces and locking the blades etc. Replacement of defective blade, if required including its transportation from store.	2.00%
20	Arrangement of NFT team along with operator, technological pieces, for measurement and rectification work for improvement of NFT value. Expert for blade root matching to be arranged by vendor.	2.00%
21	MPI of all dismantled blades and rotor grooves, Arrangement of MPI kits (coil method) including operator is included in the vendor's scope Consumables for MPI (MAGNAFLUX or Equivalent) as required are to be supplied by successful bidder.	2.00%
22	Inspection and cleaning of LP exhaust hood spray nozzles. Carry out DPT of LP exhaust spray line Weld joints & rectification of same by welding.	0.25%
A.3	GENERAL ACTIVITIES OF TURBINE	(20.00%)
1	Assistance during pre-shutdown & post shut down inspection of the machine and recording the parameters.	0.25%
2	Dismantling and re-assembly of turbine-enclosure as per requirement.	0.50%
3	Opening of bearing pedestal covers and removal of bearings for inspection and recording of rotor and casing control dimensions.	0.50%
4	Coupled run out and float of rotor system to be checked and recorded. Measurement of reference readings during dismantling and assembly	0.50%
5	De-coupling and coupling of LP rotor, IP rotor, HP rotor and MOP. Final measurement of coupled run out and swing value.	0.50%
6	Alignment check of turbine rotors and corrections.	0.50%
7	DP test and ultrasonic test of turbine bearings, thrust pads for cracks in metal bonding. DPT & UT of spare bearings and thrust pads (in case of replacement) also included in vendor's scope. UT & DP test kit along with accessories and operator is in the Vendor's scope.	1.00%
8	Blue matching of torus piece with base plate to the extent possible at site. Replacement of bearings and thrust pads (if found not acceptable / damaged) by spares is included in vendor's scope.	1.50%
9	Coupling of LP/GEN, LP/IP, IP/HP and HP/ MOP. Reaming and honing of coupling holes and replacement of coupling bolts including machining of coupling bolts outside plant if required.	1.00%
10	Adjustment of bearing clearances and thrust float, boxing-up of all bearings, repair/ replacement and resetting of bearing yoke keys, pads and oil guard fins/sealing strips, oil guard ring set etc. as required.	1.00%
11	Inspection of the clearance between the rotor and the oil guard ring is to be done. If it has exceeded the limit then the fins / sealing strips are to be replaced and machined in specialized work shop outside power plant to get the designed value. To & fro transportation of the items for machining outside the power plant is also included in vendor's scope. Machining of oil guard fins / sealing strip, pads, yoke keys etc. are included in vendor scope.	1.00%
12	Servicing and adjustment of thrust bearing trip device, over speed trip device, barring gear system, emergency speed governor etc. as applicable. Servicing of over speed trip bolts. Servicing of hydraulic turning motor system including overrun clutch and replacement of damaged components as required.	1.00%

13	Centering check, rolling check, axial bump check, swing check and Horn drop test of HP, IP & LP cylinder and correction as required, Fixing and Lubrication of all sliding keys and packers of the cylinders etc. maintaining proper clearances. Removal / dismantling and re insulation of damaged portion as required. Preparation for platform below HP and IP turbine, as required to carry out the job.	1.00%
14	Dismantling of MOP, Inspection of bearings, seal rings, shaft impeller etc. and replacement of damaged parts including bearings, impeller etc. Machining of bearings in work shop outside the plant as required including to & fro transportation is included in scope.	1.00%
15	Catenary checking of all pedestal & correction as per requirement. Arrangement of 07 numbers pot along with pipe lines included in vendor's scope.	1.00%
16	Anchor plates matching for pedestals. Foundation bolts de-stretching & re-stretching / tightness checking as required of all bearing pedestal including and exciter foundation bolt. Stretching device arrangement to be done by vendor. Proper scaffolding to be carried out by vendor.	0.75%
17	Oil flushing of turbine bearings, resetting of throttles including periodic cleaning of bearing filter, basket filter of MOT, thrust bearing duplex filters. Setting of JOP header pressure and checking of individual lift. Bearings normalization after oil flushing.	0.50%
18	Putting the machine on barring gear with proper adjustment of jacking oil and Lube Oil pressure at bearings. Assistance during barring gear	0.50%
19	Arrangement of four (4) EOT crane operators duly vetted by customer and BHEL site Engineer in-charge for round the clock basis during entire duration of work.	0.75%
20	Arrangement of granite surface plate of 0.01 mm accuracy of 1 x 1 meter ² size, 4nos. of 50 tonnes, 4 nos. of 25 tonnes & 4 nos. of 100 tonnes hydraulic jacks with pumping units in good working conditions	0.50%
21	Adjustment of spring heights of TG deck before removal of components and during final alignment correction for spring deck system. Arrangement of Hydraulic jacks, scaffolding near spring deck as may be required. TG deck locking, adjustment, necessary correction, unlocking etc., catenary checking and correction as per requirement under supervision of M/s GERB expert. Arrangement of GERB expert is included in the vendor's scope.	2.00%
22	Painting of LP outer casing, pedestals, GEN & Exciter, governing and LPBP rack with standard colour code, Servomotors of HP, IP, HPBP & LPBP stop and control valves. (Supply of paints included in vendor's scope).	1.00%
23	To and fro transportation of slow speed balancing machine including arrangement of necessary trailer (32 feet), loading & unloading from other BHEL-Site located at West Bengal/Jharkhand for balancing of rotor (s) at the site. Transportation of stub shaft also included from same place.	0.75%
24	Checking & rectification of BP leak off line for distortion.	1.00 %
A.4	HANGER INSPECTION	(5.00%)
	Carrying out hanger setting & adjustment of turbine area hangers in MS, CRH & HRH, PRDS BP line and Turbine integral piping in turbine area piping etc. as given below:- a) Making necessary scaffolding & approach platform for servicing. b) Hanger cold & hot readings are to be recorded. c) Checking of Freeness of hangers. d) Checking of fouling of hanger with the structure/wall e) Removal of welding of hanger support with surrounding structure for the purpose of temporary supports if any. f) Checking for any visual deviation of hanger elevation noticeable or looseness of hangers. g) Adjustment of necessary hangers & supports as per requirement. h) Any modification / rectification for the above job as required to be done by the vendor.	

Note	Vendor has to depute one expert along with accommodation duly vetted by BHEL Site Engineer In Charge for a period 8 (eight) days for inspection and rectification of piping hanger & support, failing which an amount of Rs 5000/- per man day will be deducted.	
A.5	TURBINE VALVES OVERHAULING	(7.00%)
	<p>a) HP stop and control valve with servomotors - 2 Sets b) IP stop and control valve with servomotors – 2 Sets WORK TO BE DONE AS UNDER:-</p> <p>i) Making necessary scaffolding & approach platform for servicing. ii) Removal of insulation as required. iii) Draining of oil from valve servomotor housing. Disconnection of oil pipelines and steam leak off lines. iv) Decoupling of valve and servomotor stem. Removal of servomotor and valve cover with valve cone. v) Arrangement of induction heating for opening of valve casing studs. vi) Dismantling of servomotor and valves. Cleaning of all components, repair / replacement of damaged parts. Modification of valve bush and cone clearance, if found necessary. vii) Cleaning of servomotor pilot valve assembly. viii) Assembly of valve and servomotor as per the designed clearance after servicing. ix) Blue matching of all valves seats with seating. Lapping to be done with fabrication of lapping devices as per requirement. x) Placement of valve and servomotors and coupling etc. Dismantling and assembly of C&I probes along with limit switch. Calibration and setting of the strokes. xi) Fixing of oil and steam lines xii) Setting of valves characteristics xiii) Dismantling and fixing of position transmitter</p> <p>i) Functional Check of EHA of SV/CV ii) Replacement of four actuators of SV/CV iii) Removal of temporary platforms and Scaffoldings iv) Minor repair/ welding/ machining of spindle/ stems/ seats etc. as required in specialised work shop outside power plant to get the designed value including to & fro transportation of the items for machining outside the power plant is also under vendor's scope.</p>	
B	GENERATOR :	(33.00%)
B1	GENERAL ACTIVITIES	(10.50%)
1	Complete dismantling and reassembly of acoustic enclosure. Air leak test of Generator at 4.0 Kg/cm ² for checking of air leak through all bushing terminals, stator RTD terminal flanges etc. Disconnection of excitation cable at slip ring and removal of brush gear assembly.	1.00%
2	Dismantling and removal of TG/Exciter enclosures. Check couple run out of L.P. – Gen. Rotors and de-couple. Check alignment and free run out after top half removal of bearings. Dismantling of exciter covers. Record Gen. Exciter Rotors coupled run out, swing check of slip-ring Rotor, Decouple slip-ring Rotor. Check alignment.	2.00%
3	Dismantling of oil and water pipelines. Removal of all Hydrogen Coolers, dismantling and inspection of coolers and replacement of all gaskets. Hydro test of hydrogen coolers to be carried out. Plugging of the tubes to be done, if any leakage in the tube is found [Plugs to be provided by CESC].	2.00%
4	Dismantle bearings and record clearance / interference.	0.50%
5	Dismantle Hydrogen seals, inner oil catchers after recording clearances. Remove top half end shields. Record stator air gap, magnetic offset. Lower bottom half end shields.	1.50%
6	Rotor threat out	0.50%
7	Heating and varnishing of Stator winding, Winding Guards, Fan Guard Covers, other insulating sheets, generator rotor etc. 16 nos. halogen lamp of 1000 watts each are to be arranged by the bidder within the quoted price for proper heating of stator and rotor.	1.00%

	Varnishing of the stator is to be done with dry oxygen. Varnish & dry oxygen shall be arranged by vendor.	
8	Machining & Transportation of Oil catcher,H2 Seal Ring etc. to be carried out by the vendor.	1.00%
9	Assistance during following electrical tests of stator & rotor to be provided by vendor. Stator:- a) DIGITAL ELCID test b) Partial discharge probe test c) IR & PI test with 5 kV megger d) DC winding resistance e) TAN-Delta of stator winding Rotor:- a) Digital RSO test b) IR & PI test with digital megger c) DC winding resistance d) AC impedance Note: Test kit with operator for these tests will be arranged by the BHEL. Vendor shall provide necessary assistance for gate pass & movement of test kit in TG floor.	1.00%
B2	GENERATOR STATOR	(1.50%)
10	Inspection of stator core overhangs. Thorough cleaning of stator internals. Straightening and matching of H2 cooler pipe lines connected with stator casing to make it proper leak-proof.	1.00%
11	Assistance during NFT of stator overhang portion	0.50%
B3	GENERATOR ROTOR	(6.00%)
12	Cleaning of rotor and removal of paints from retaining rings and fan blades. Conduct DPT and UT of retaining rings and fan blades in position. DPT & UT of Bearings. Inspection of rotor wedges and balancing weights.	1.00%
13	Gas tightness test of rotor	0.50%
14	Any leakages from the CC bolt, sealing washers during air leakage are to be attended and replacement of sealing washers/gaskets/ CC bolts as required. Air leakage of Rotor to be done as per norm. Vendor has to arrange expert technician(s) acceptable to BHEL Site Engineer for attending the CC bolt, sealing washers. All T&Ps including Torque wrench (up to 1700 NM) and consumables required for correction like Rubber compound K and Hardener T-37 to be arranged by the vendor.	3.00%
15	Polishing of bearing Journals by coir rope only. Rotor coupling facial run out checking and correction	0.50%
16	Inspection of bearings, Hydrogen Seals, Oil catchers and end shield etc. Inspection of all phase and neutral bushings and replacement of sealing gaskets of bushings as required. Air-tightness test of the bushings independently (outside).	1.00%
B4	ASSEMBLY:	(9.00%)
17	Box up of hydrogen coolers, pipe lines and dismantled parts. All RTD and thermocouple inspection and replacement only those wherever accessible. Conduct DPT & UT on bearings / hydrogen seals, replacement of bearings 5 & 6 (if required). DPT on LP - Generator coupling bolts	2.50%
18	Thread in of Generator rotor. Assembly of bottom half end shields. LP-Gen. rotor alignment, reaming / honing as required. Coupling and CRO checking. Assembly of top end shields, inner oil catchers etc.	3.50%

19	Checking of all clearances of bearings, labyrinth rings, oil catchers, hydrogen seals etc. Replacement of cords/ gaskets, sealing strips/ fins etc. Assembly of hydrogen seals. Injection of RTV-732 Silicone Sealant (Silicone Sealant with sealing gun to be arranged by the bidder within the quoted price) into end shields. Assembly of bearings ensures bearing pedestal insulation resistance. Machining & transportation of oil catchers and seal rings under vendor's scope.	3.00%
B5	SLIP-RING ROTOR :	(6.00%)
20	Check couple run out of generator rotor to slip ring shaft.	0.20%
21	Decouple slip ring shaft to generator rotor.	0.20%
22	Resting of slip ring shaft on support.	0.10%
23	UT & DPT of bearing -7.check oil clearances like SOC, TOC of bearing-7. Replacement of bearing-7 if required. Check multi contact pins and replacement, if required.	0.25%
24	Alignment (axial only) of slip ring shaft to generator rotor.	0.50%
25	Measure swing check of slip ring shaft to generator rotor.	0.25%
26	Coupling & couple run out of slip ring shaft to generator rotor. Restoration of oil piping to bearing pedestal-7. Check IR values of bearing pedestal-7 and oil piping to pedestal. Restoration of DC cables to slip ring shaft.	0.50%
27	Mounting of outer hood in position.	0.10%
28	Vendor has to depute one Generator expert winder including accommodation duly vetted by BHEL Site Engineer In Charge for a period 7 days.	2.00%
29	Assembly of sealing walls, hoods, enclosures etc. Assistance for oil flushing of bearing. Seal oil establishment & Generator air tightness test. Placement of TG on turning gear. Assistance during Generator dry out, if necessary, and Generator bus duct connection. Oil flushing and necessary arrangements for it. Generator seal establishment and air leakage test. Putting TG on barring gear. Assistance during trim balancing as may be required including post overhauling vibration signature analysis.	1.90%
C	ASSISTANCE DURING COMMISSIONING/SYNCHRONIZATION OF THE UNIT AND OBSERVATION FOR 72 HRS AFTER SYNCRONIZATION OF MACHINE	(5.00%)
1	Vendor has to deploy two nos. of safety officers having qualification of Diploma in Safety / customer for round the block basis to co-ordinate all above mentioned activities and to fulfil other statutory requirements.	
2	Vendor has to maintain necessary housekeeping at BHEL site office	
3	<i>ASSISTANCE DURING COMMISSIONING/SYNCHRONIZATION OF THE UNIT AND OBSERVATION FOR 72 HRS AFTER SYNCRONIZATION OF MACHINE</i>	

INPUTS REQUIRED FROM SUCCESSFUL BIDDER

01. T & P AND IMTES FOR PERFORMING THE SUBJECT JOB
02. SCAFFOLDING MATERIALS & WOODEN PLANKS AS REQUIRED

General scope of work and terms:

01. Transportation of spares from customer store to site and return to store if not used.
02. Transportation of special T& Ps, lifting tackles etc. from customer store to site and return to store after job completion.
03. Issuing and returning of materials from customer store and returning back & material reconciliation.
04. General illumination is available but for carrying out overhauling job any illumination is required is to be arranged.
05. After completion of work, the area shall be cleared up to the satisfaction of BHEL Site Engineer in charge/customer. Disposal of scrap/ waste/ insulation / debris generated while overhauling work to be disposed off at predetermined place as indicated by customer by the bidder including transportation of the waste.

06. The contractor shall have to bear for the loss of any damage to the items belonging to customer due to Improper handling / storing or improper fitting etc. and necessary recoveries will be made from the Contractor.
07. The contractor shall erect approach platform as per requirement and dismantle the same. Scaffolding material shall be brought by the contractor.
08. The contractor shall be fully responsible for maintenance of records of his employees.
09. Contractor shall engage his personnel round the clock and shall submit detailed work plan, bar chart, manpower deployment plan (in nos. and skill level only) round the clock and work progress and these shall be discussed and agreed prior to award of contract.
10. Housekeeping: Maintaining proper cleanliness around the work area is the contractor's responsibility. The contractor has to depute separately identified persons exclusively for area cleaning.
11. Safety Requirements: All persons working shall strictly follow the CUSTOMER safety norms. Contractor shall be solely responsible for ensuring the safety of his all worker / employees.
12. Contractor shall provide and ensure the proper use of all safety gadgets (PPE) to / by his all employees / workers engaged for this work. Contractor shall provide following safety gadgets confirming to the IS norms: safety helmets, safety goggles, safety shoes, hand gloves, & safety belts. Failing to the issue or use of the safety gadgets based on the requirement or violation of safety norms will attract penalty as per customer / BHEL safety rule. Contractor shall arrange necessary safety gadgets/PPE for BHEL persons also.
13. The contractor shall ensure that safety related awareness training has been given to his all workers / employees at the time of start of contract and it is mandatory to obtain identity card for the same from Customer safety department.
14. Contractor to take care of safety exclusively of his workers / employees engaged for the subject work. Contractor shall also ensure that there shall not be any safety hazard to the persons / machines in the vicinity due to his activities.
15. All lifting tools and tackles to be used shall be having the valid test certificate (with proper identification mark on the tools) from government approved agency and the same shall be produced to Engineer before start of work.
16. Other Requirements: Contractor shall ensure that environmental related awareness training has been given to his workers / employees at the time of start of contract.
17. Agency has to arrange their own incoming / outgoing Road permit for the T&Ps, materials, consumables etc required for the work.
18. Deployment of one Safety Officer (round the clock) having qualification of Diploma in Safety for entire duration of the job.

TAXES AND DUTIES:

	TAXES, DUTIES ETC
1	All taxes excluding GST & BOCW Cess (as specified elsewhere in the tender) but including, Charges, Royalties, any State or Central Levy and other taxes for materials if any obtained for the work and for execution of the contract shall be borne by successful bidder and shall not be payable extra by BHEL. Any increase of above at any stage during execution of contract, including extension of the contract, shall have to be borne by successful bidder contractor. Bidder's quoted/ accepted rates/ price shall be inclusive of all such requirements.
2	GST along with Cess (as applicable) legally leviable & payable by successful bidder as per GST Law shall be paid by BHEL, extra. Hence, bidder shall not include GST along with Cess (as applicable) in their quoted rates/ price.
3	Successful bidder shall furnish proof of GST registration with GSTN Portal covering the services under this contract. Registration should also bear endorsement for the premises from where the billing shall be done by successful bidder on BHEL for this project / work.
4	Since GST on output will be paid by BHEL separately as enumerated above, bidder's your quoted rates / price should be after considering the Input Credit under GST law at bidder's end.
5	TDS under Income Tax Act shall be deducted as per prevailing IT rules from the bills.
6	TDS under GST shall be deducted as per prevailing GST rules from the bills.
7.1	You may collect TCS under section 206C(1H) of Income Tax Act, 1961 if applicable.
7.2	In case, you collect TCS under section 206C(1H) of Income Tax Act, 1961, following compliance is required.
7.2.1	TAN and PAN of vendor should appear in all invoices/claims. Copy of TAN /TCS registration is to be submitted.
7.2.2	Amount of TCS and Assessable value on which TCS has been calculated should be specified clearly in the invoice.

7.2.3	You shall be required to submit certificate of TCS in Form no. 27D within 15 days from the due date for furnishing the statement of tax collected at the source.
7.3	In case, you do not collect TCS under section 206C(1H) of Income Tax Act, 1961, following declaration is to be submitted alongwith each invoice: - "I/We hereby declare that I/We are not required to collect TCS under section 206C(1H) of Income Tax Act, 1961, on this bill.
7.4	In event of failure to comply with the provisions of the Act, or proper certificate not issued, or if tax collected but not remitted to the Government, or for any other reason and thereby causing loss to BHEL, the same shall be recoverable from the vendor with applicable interest.
7.5	You shall comply with all statutory amendment/notifications in this respect.
8	Bidder shall note that GST Tax Invoice complying with GST Invoice Rules (Section 31 of GST Act & Rules referred thereunder) wherein the 'Bill To' details shall encompass following. BHEL GSTN – 19AAACB4146P1ZC NAME: Bharat Heavy Electricals Limited ADDRESS: BHEL-PSER DJ-9/1, sector-II Salt Lake City, Kolkata-700 091 West Bengal, India
9	Successful bidder to intimate immediately on the day of removal of goods (in case of any supply of goods) to BHEL along with all relevant details and send a scanned copy of Tax Invoice to BHEL through following communication mode for enabling BHEL to meet its GST related compliances. Portal address. and Email address – Shall be intimated later. Specific details of above shall be intimated to successful bidder by BHEL at appropriate juncture.
10	In case of delay in submission of above mentioned documents on the date of despatch, BHEL may incur penalty / interest for not adhering to Invoicing Rules under GST Law. The same will be liable to be recovered from successful bidder, in case such delay is not attributable to BHEL.
11	In case of raising any Supplementary Tax Invoice (Debit / Credit Note), successful bidder shall issue the same containing all the details as referred to in Section 34 read with Section 31 of GST Act & Rules referred there under.
12	Successful bidder shall comply with the Time Limit prescribed under the GST Law and rules thereof for raising of the Tax Invoice. If any supply of goods is applicable, successful bidder shall also ensure prompt delivery of goods after despatch.
13	Bidder shall note that in case GST credit is delayed / denied to BHEL due to delayed / non receipt of goods and / or Tax Invoice or expiry of the timeline prescribed in GST Law for availing such ITC, or any other reasons, not attributable to BHEL, GST amount shall be recoverable from successful bidder along with interest levied/ leviable on BHEL, as the case may be.
14	Successful bidder shall upload the invoices raised on BHEL in GSTR-1 within the prescribed time as given in the GST Act, and the same shall be available to BHEL in FORM GSTR-2A/2B electronically through the common portal. Bidder shall note that in case of delay in declaring such invoice in your return and GST credit availed by BHEL is denied or reversed subsequently as per GST Law, GST amount paid by BHEL towards such ITC reversal as per GST law shall be recoverable from the successful bidder along with interest levied / leviable on BHEL.
15	Way Bill: Successful bidder to arrange for way bill / e-waybill for any transfer of goods for the execution of the contract. Successful bidder has to make their own arrangement at their cost for completing the formalities, if required, with Issuing Authorities, for bringing materials, plants & machinery at site for execution of the works under this contract, Road Permit / Way Bill, if required, shall be arranged by successful bidder and BHEL will not supply any Road Permit/ Way Bill for this purpose.
16	Any new taxes & duties, if imposed subsequent to due date of offer submission as per NIT & TCN, by statutory authority during contract period (including extension, if the same is not attributable to you), shall be reimbursed by BHEL on production of relevant supporting document to the satisfaction of BHEL. However, you shall obtain prior approval from BHEL before depositing new taxes and duties.
17	Benefits and / or abolition of all existing taxes must be passed on to BHEL against new taxes, if any, proposed to be introduced at a later date.

-----X-----

Annexure –BOCW

Specific clause wrt BOCW Act & Cess Act

1. It shall be the sole responsibility of the contractor as employer to ensure compliance of all the statutory obligations under the Building and other Construction Workers' (Regulation of Employment and Conditions of Service) Act, 1996 and the Building and other Construction Workers' Welfare Cess Act, 1996 and the rules made thereunder.
2. It shall be sole responsibility of the contractor engaging Building Workers in connection with the building or other construction works in the capacity of employer to apply and obtain registration certificate specifying the scope of work under the relevant provisions of the Building and Other Construction Workers' (Regulation of Employment and Conditions of Service) Act, 1996 from the appropriate Authorities.
3. It shall be responsibility of the contractor to furnish a copy of such Registration Certificate within a period of one month from the date of commencement of Work.
4. It is responsibility of the contractor to register under the Building and other Construction Workers' Welfare Cess Act, 1996 and deposit the required Cess for the purposes of the Building and other Construction Workers' (Regulation of Employment and Conditions of Service) Act, 1996 at such rate as the Central Government may, by notification in the Official Gazette, from time to time specify. However, before registering and deposit of Cess under the Building and other Construction Workers' Welfare Cess Act, 1996, the contractor will seek written prior approval from the Construction Manager.
5. In case where the contractor has been accorded written approval by the Construction Manager and the contractor is required to furnish information in Form I and deposit the Cess under the Building and other Construction Workers' Welfare Cess Act, 1996, fails to do so, BHEL reserves right to impose penalty at the rate of 30% of Cess Amount.
6. It shall be sole responsibility of the contractor as employer to get registered every Building Worker, who is between the age of 18 to 60 years of age and who has been engaged in any building or other construction work for not less than ninety days during the preceding twelve months as Beneficiary under the Building and other Construction Workers' (Regulation of Employment and Conditions of Service) Act, 1996.
7. It shall be sole responsibility of the contractor as employer to maintain all the registers, records, notices and submit returns under the Building and other Construction Workers' (Regulation of Employment and Conditions of Service) Act, 1996 and the Building and other Construction Workers' Welfare Cess Act, 1996 and the rules made thereunder.
8. It shall be sole responsibility of the contractor as employer to provide notice of poisoning or occupation notifiable diseases, to report of accident and dangerous occurrences to the concerned authorities under the Building and other Construction Workers' (Regulation of Employment and Conditions of Service) Act, 1996 and the rules made thereunder and to make payment of all statutory payments & compensation under the Employees' Compensation Act, 1923.

Annexure –BOCWSpecific clause wrt BOCW Act & Cess Act

9. It shall be responsibility of the Contractor to furnish BHEL on monthly basis, Receipts/ Challans towards Deposit of the Cess under the Building and other Construction Workers' Welfare Cess Act, 1996 and the rules made thereunder along with following statistics :
 - (i) Number of Building Workers employed during preceding one month.
 - (ii) Number of Building workers registered as Beneficiary during preceding one month.
 - (iii) Disbursement of Wages made to the Building Workers for preceding wage month.
 - (iv) Remittance of Contribution of Beneficiaries made during the preceding month
10. BHEL shall reimburse the contractor the Cess amount deposited for the purposes of the Building and other Construction Workers' (Regulation of Employment and Conditions of Service) Act, 1996 under the Building and other Construction Workers' Welfare Cess Act, 1996 and the rules made thereunder. However, BHEL shall not reimburse the Fee paid towards the registration of establishment, fees paid towards registration of Beneficiaries and Contribution of Beneficiaries remitted.
11. It shall be responsibility of the Building Worker engaged by the Contractor and registered as a beneficiary under the Building and other Construction Workers' (Regulation of Employment and Conditions of Service) Act, 1996 to contribute to the Fund at such rate per mensem as may be specified by the State government by notification in the Official Gazette. Where such beneficiary authorizes the contractor being his employer to deduct his contribution from his monthly wages and to remit the same, the contractor shall remit such contribution to the Building and other construction Workers' Welfare Board in such manner as may be directed by the Board , within the fifteen days from such deduction.
12. If any point of time during the contract period, non-compliance of the provisions of the Building and other Construction Workers' (Regulation of Employment and Conditions of Service) Act, 1996 and the Building and other Construction Workers' Welfare Cess Act, 1996 and the rules made thereunder is observed, BHEL reserves the right to withhold a reasonable amount from the payables to discharge any obligations on behalf of Contractors. The reasonable amount shall be decided by the Construction Manager in consultation with Resident Accounts Officer & Head HR and shall be final.
13. The contractor shall declare to undertake any liability or claim arising out of employment of building workers and shall indemnify BHEL from all consequences / liabilities / penalties in case of non compliance of the provisions of the Building and other Construction Workers' (Regulation of Employment and Conditions of Service) Act, 1996 and the Building and other Construction Workers' Welfare Cess Act, 1996 and the rules made thereunder.

ANNEXURE – SAS-I

ESSENTIAL CONDITIONS TO BE FULFILLED BY SUCCESSFUL BIDDER

01. Successful bidder has to arrange 6 copies of overhauling reports which will include various protocols with necessary data / MOMs / important correspondences / log sheets/ colour photographs etc. and the books shall be spiral bound with thick acetate papers in front and back along with BHEL logo printed suitably on thick art paper at the front.
02. Bidder has to arrange to provide PC with internet connection, with colour printer and Xerox paper as required for taking print out compatible with WINDOW vista version or, latest version loaded with necessary software, during entire period of execution of job at site , for preparing /maintaining / up keeping of various correspondences/ protocols/log shts. etc. . PC shall be operated by PC operator conversant with AUTOCAD and other softwares to be arranged by the successful bidder within the scope. All data thus stored during the execution of job shall be handed over to Resident Manager at site after the Overhauling for submission to Customer. In case vendor fails to provide the PC operator, Rs 8000/- per month shall be deducted from vendor's bill.
03. Successful bidder is to render services for proper up-keepment of BHEL site office as required. Full time office boy is required to be provided by the successful bidder at site for up keepment of site office.
04. After dismantling and during execution of the job, successful bidder has to suitably tag the components and sub-assemblies for trace ability and store properly before final assembly. This is as per instruction of BHEL Site in charge.
05. Process control of Special Processes like Welding and Heat Treatment shall be carried by successful bidder as per instruction of BHEL Site in charge.
06. Proper segregation, identification, tagging and up-keep of all dismantled items at work site during job execution have to be done by successful bidder.
07. Successful bidder is to obtain necessary "No Dues" certificates before de- mobilisation from site.
08. Successful bidder is to comply with all the statutory and regulatory norms, rules and practices as applicable for the job/site.
09. Successful bidder shall provide valid calibration certificates for IMTEs, fitness certificates for T&Ps and Construction Equipment (e.g. wire ropes, hand operated chain pulley blocks, pulling and lifting machines, electric welding generators, arc welding transformers etc.). Calibration of IMTEs is to be arranged from the accredited agencies. Calibration certificates should have the traceability as per national/international standards. At work site the IMTEs, T&Ps and Construction Equipment shall be checked/tested/inspected by BHEL engineers. The procedure for fitness testing and storage preservation and maintenance of Construction Equipment and T&Ps shall be as per instruction of BHEL site engineers.
10. Successful bidder should follow all safety norms at work site as per instruction of BHEL engineer at site.
11. Any NDT within the scope shall be as per instruction of BHEL site engineer.
12. Provision of packaged drinking water facility at BHEL site office.
13. The successful bidder is to arrange a full set of First Aid kit for attending to manpower deployed by him at site as per requirement.
14. The successful bidder is to arrange extra illumination at work site to augment the existing site illumination if required to enable round-the-clock safe working.
15. Vendor shall submit daily job plan & progress report to the concerned BHEL Engineer, review the programme from time to time.
16. Special barricading is to be done for working area. Entry of persons to working area is to be controlled during O/H.

ANNEXURE-II**TENTATIVE LIST OF T & P**

Tentative List T&Ps for the job is mentioned below. Vendor has to arrange T&Ps as may be required for successful completion of the job. T&Ps are to be mobilized by vendor as and when required to match the work schedule & complete the job on time. BHEL has the authority to penalize the contractor suitably including termination of contract if the required/necessary T&P's are not mobilized in time for successful completion of job.

Sl. No.	MEASURING TOOLS	Quantity
1.01	Dial Indicator with Magnetic Base	6 sets
1.02	Dial indicator – button type and LASTWARD (3 mm travel, 25 mm dia dial with links for coupling alignment)	2 set each
1.03	Slip gauge up to 10 mm	1 set
1.04	Micro-head level, accuracy 0.1 mm per metre, 150 mm long	1 no.
1.05	Square level for leveling major parts for installation (accuracy 0.1 mm, 150 mmX150 mm)	1 no.
1.06	Vernier Caliper 150 mm and 300 mm	1 no. each
1.07	Set of spring caliper and divider(150 mm)	1 set
1.08	Zenith caliper for marking (150 mm)	1 no.
1.09	Steel Scale 150 mm, 300 mm, 1000 mm	2 nos each
1.10	Telescopic gauge up to 150 mm	1 set
1.11	Bore dial gauge up to 75 mm	1 set
1.12	Inside micrometer up to 1500 mm	1 set
1.13	Outside micrometer	2 nos
	0-25 mm	
	0-50 mm	1 no.
	50-200 mm	1 no.
	200-300 mm	1 no.
	300-400 mm	1 no.
	400-500 mm	1 no.
1.14	Taper Gauge up to 20 mm	1 no.
1.15	Taper gauge 0.1 – 10 mm	1 no
1.16	Feeler gauge 100 mm, 200 mm, 300 mm long (from 0.03 to 1.0 mm thick)	1 set each
1.17	Feeler strip 0.03 mm, 0.04 mm, 0.05 mm, 0.10 mm X 300 mm long	5 each
1.18	Thread Gauge M4 to M56	1 set
1.19	Depth micrometer 0-25 mm	1 no.
1.20	Surface plate 300 mm X 300 mm	1 no.
1.21	Combination set	1 no.
1.22	Ball pen gauge for 3 to 10 mm bore	1 set
1.23	Measuring steel tape 3 M, 15 M	2 each
1.24	500 V hand / motorized megger	1 no.
1.25	1000 V hand / motorized megger	1 no.
1.26	250 V megger	1 no.
1.27	3 1/2 Digit digital multimeter	1 no.
1.28	Lever type dial gauge for centering	1 no.

CUTTING TOOL

2.01	Tap set M 5 to M42 (including M27 & m 33)		1 set each
2.02	Die set M 14 to M 65		1 set each
2.03	Pistol Drill	6 mm	2 nos.
	-Do-	15 mm	1 no.
	-Do- with magnetic stand	19 mm	1 no.
2.04	Straight grinder GQ 4		3 nos.
2.05	Angle grinder AG 7 and AG 5		2 nos. each
2.06	Pistol grinder		1 no.
2.07	Flexible grinder with necessary accessories		2 nos.
2.08	Bench grinder 150 mm		1 no.
2.09	Hole punch up to 32 mm		1 set
2.10	Easy out up to M 24		1 set
2.11	Taper reamer up to 18 mm		1 set
2.12	Hand ratchet		2 nos.

LIFTING TOOL

3.01	Sling- 8 mm, 2.5 metre long tip to tip along with 150 mm eye at both end		1 pair
3.02	Sling 12 mm, eye at both end of 300 mm,	1.5 metre long	1 pair
		2.5 metre long	1 pair
		3.5 metre long	1 pair
3.03	Sling 19 mm, eye at both end of 450 mm,	2.0 metre long	1 pair
		3.0 metre long	1 pair
3.04	Sling 25 mm, eye at both end of 450 mm,	3.0 metre long	1 pair
		6.0 metre long	1 pair
3.05	Eye bolt 10, 12, 14 & 16		4 nos. each
3.06	Eye bolt 20, 24, 27, 36 & 42		2 nos. each
3.07	D-shackles pin dia. 10 mm, 12 mm		5 pairs each
	D-shackles pin dia. 20 mm, 25 mm, 32 mm, 36 mm & 44 mm		1 pair each
3.08	Ratchet hoist 0.5 T		1 no.
3.09	Chain block 2 T, 5 T		1 no. each
3.10	Manila rope 25 mm, 30 metre long		1 pair
3.11	Cotton rope 25 mm, 10 metre long		1 no.

OTHER T & P

4.01	Gas welding machine		1 set
4.02	Hand lamp with 30 metre cable		6 nos.
4.03	Switch board with 50 metre cord		2 nos.
4.04	Scissors-300 mm		1 set
4.05	Shim cutter – 350 mm		1 set
4.06	Magnifying glass – 75 mm dia		1 no.

4.07	Mirror with handle	1 no.
4.08	Vacuum cleaner	1 no.
4.09	Carpenter's saw	1 no.
4.10	Carpenter's chisel	3 nos.
4.11	Open "D" D.E. spanner 36X41, 41X46	2 nos. each
4.12	S.E. span "D" spanner 46, 50, 55, 65, 70, 75, 80, 85, 90, 95, 100, 105	1 no each
4.13	Slogging spanners 36, 41, 55, 65	2 nos. each
4.14	Slogging spanner 46 mm	4 nos.
4.15	Slogging spanners 50, 60, 70, 75, 80, 85, 90, 95, 100, 105	1 each
4.16	Box spanner set with straight handle, ratchet handle, universal extension piece – all heavy duty, up to 46 mm	1 set
4.17	Tubular spanner 20 to 46 mm	1 set
4.18	Allen key set 4 to 27	2 sets
4.19	Pipe wrench 150, 350 & 450 mm	1 no. each
4.20	Slide wrench 200 mm, 300 mm	2 nos. each
4.21	Spray gun for generator varnishing / painting with necessary high pressure hose	1 no.
4.22	High pressure air hose at least 30 metre long	1 no.
4.23	Tubular spanner	1 set
4.24	Gland packing remover	1 set

HAND TOOLS

5.01	Chisels (Chrome-Vanadium) 1 mm	6 nos.
5.02	Center punch (Chrome-Vanadium) small & big	1 each
5.03	Letter punch – 4 mm size	1 set
5.04	Number punch – 6 mm size	1 set
5.05	Bearing scrapper – half round and triangular	2 nos. each
5.06	Flat scrapper (made out of 1.5 inch power saw blades and pipes)	8 nos.
5.07	Hammer 250 gms., 500 gms.	1 no. each
5.08	Hammer 1 kg., 2 kg.	3 nos. each
5.09	Hammer 5 kg.	2 nos.
5.10	Hammer 8 kg.	1 no.
5.11	Copper Hammer 2 kg.	1` no.
5.12	Lead Hammer 2 kg.	1 no.
5.13	Nylon mallet	3 nos.
5.14	Needle file	2 sets
5.15	Assorted file	4 dozens
5.16	Screw driver 150 mm, 300 mm, 450 mm (Taparia make)	2 nos. each
5.17	Tommy bar 32 mm X 1 metre	1 no.
5.18	Crow bar – big and small	2 nos. each
5.19	Hole bar (Assorted size)	4 nos.
5.20	Hacksaw frame (good quality)	2 nos.
5.21	Pliers, cutting nose, grip, O/S circlip, I/S circlip	2 nos. each

5.22	Magnetic needle for dust in small holes	1 no.
5.23	Oil stone (rough and smooth)	6 nos. each
5.24	H.S.S. 12 mm square section X 100 mm parallel bits (accurate with 0.01 mm in section)	2 nos.
5.25	Copper rod 12 mm dia., 25 mm dia., 50 mm dia., 300 mm length	1 pc. Each
5.26	Bench vice 150 mm	2 nos.
5.27	Channel lock 150 mm	2 nos.
5.28	Vice grip 150 mm	1 no.
5.29	Cutogen gas cutting set with hose, jubilee clamps and regulators	1 set
5.30	Hydraulic jacks (50 tons capacity)	4 nos.
5.31	Welding generators (with lead holder)	1 no.
5.32	Brazing torch set	2 no.
5.33	Cutting nozzle no 19, 20	2 no each
5.34	Hydraulic jacks (25 tons and 100 tons capacity)	4 nos. each

The above list of T&P's are not exhaustive but indicative only .Any shortage may be made up by the vendor as may be required for overall job completion.

ANNEXURE – III

LIST OF CONSUMABLES TO BE ARRANGED BY THE CONTRACTOR IN ADDITION TO THE NORMAL CONSUMABLES.

The following consumable to be arranged by Vendor as per requirement.

1. Dye penetration test kit
2. Emery paper (fine and coarse)
3. Emery clothes sheets
4. Eutectic electrode L & T – 670/680
5. Nicro- 82 welding electrode & filler rod
6. All consumables as may be required for welding, brazing, gas cutting etc.
7. Petrol, Diesel
8. Rustolene, WD 40/ pen oil- 6030
9. 25 mm thick planks X 200mm wideX 3000 mm long for keeping dismantled parts
10. Ceramic cloth
11. Acetone
12. Stag B, Holdtite, M seals, Hylomar, Araldite, Silastic (RTV-732), tite seal, Teflon tape, medical tape, PVC tape, Klueber paste HEL 46-450, Tiodize T8E_H, Locktight-243, Lock tight 401/495, etc.

Any other consumables, supplementary requirement has to be provided by the vendor for successful completion of the job.

SPECIAL NOTE TO BIDDERS

01. **LUMPSUM PRICE:**
The bidders should quote lump sum price for the total scope of work mentioned in ANNEXURE– I Compliance to Annexure SAS – I is mandatory. If successful bidder fails for compliance of Annexure SAS I, then total expenditure towards the said items shall be deducted from the successful bidder's bill.
02. Successful bidder has to submit the following documents on and during execution of the job:
- Labour license for the subject work.
 - Insurance coverage of the total workers engaged for the job.
 - Monthly wage certificate of the total work force.
 - EPF for the workers engaged.
 - Submit safety plan.
 - Submit bar chart / job completion schedule as & when asked for.
 - No due certificate from Customer's personnel dept.
- Successful bidder has to obtain "No Objection Certificates" from concerned depts. and P&A dept. of customer.
- The scope under the specification (as per Annexure –I of scope of work) is not exhaustive but indicative only. However, any activity covered under the normal course of **works mentioned in Annexure-I** shall be deemed to be within the scope.
Transportation of materials, T & Ps including Special T & Ps, lifting tackles etc. from customer's site stores to work spot as per requirement along with material reconciliation and also transportation of the T&P's / Instruments etc. from BHEL-KOL HQ / OTHER Eastern Region Sites to site & back, is included in the scope of the vendor at their own cost. In case any part of the job is not carried out, a deduction will be effected as per percentage shown against those items.
03. Any related work not detailed under the above schedule of work but found essential for completion of the job has to be executed by vendor free of cost.
04. The vendor has to strictly comply with the SAFETY RULES & procedures of the customer. It is suggested that the prospective bidders may visit site to know further details of their safety rules before quoting their price.
05. Disposal of scrap/ waste/ insulation generated while overhauling work to be disposed off at predetermined place as indicated by customer by the bidder including transportation of the waste.
06. Defect liability period against bad workmanship shall be 6 (six) months from the date of commissioning/synchronization of the unit. During this period if any re work are required to be carried out, then the same are to be done by the successful bidder. The successful bidder shall be responsible for timely execution and quality of overhauling job and stand guarantee against any defect due to bad workmanship. Once defect is registered within defect liability period, the successful bidder has to rectify the same free of cost during next available opportunity.
07. **Security Deposit: Contractor shall furnish security deposit as per clause no. 1.8 of GENERAL & SPECIAL CONDITIONS OF CONTRACT [FOR SERVICES JOB] and clause no (D) of SPECIFIC TERMS AND CONDITIONS FOR SERVICES JOBS.**
08. **Terms of Payment:**
- 80% of the contract value plus BOCW cess (as applicable) but excluding the amount of GST shall be payable against submission of **progressive** running bills. Each of the billed amount shall correspond to the quantum of job actually completed and to that effect the claim can be preferred based on percentage allotments (to be given in the work order) made. This, however, has to be certified by the resident manager / engineer of the site.
 - 10% of contract value plus BOCW cess (as applicable) but excluding the amount of GST shall be payable on submission of statutory documents & 'no due certificate from customer's personnel department / receipt of final payment by BHEL from customer"
 - Balance 10% of contract value plus BOCW cess (as applicable) but excluding the amount of GST shall be payable **after completion of job / synchronization / commissioning of the unit (as applicable certified the resident manager / engineer of the site)**, availability of Performance

security towards defect liabilities/warranty obligations as per contract and on receipt of final payment by BHEL from Customer & after confirmation of full GST Credit to BHEL. Any Interest if levied thereon for reasons elaborated in Tax clause of the tender which is not attributable to BHEL will be recovered for the Final Payment / Retention.

- d) Payment will be made within **45 days** after receiving of complete bill along with relevant documents

BHEL at its discretion may further split up the percentage break up given in billing schedule and effect payment to suit site condition, cash flow requirement etc. according to progress of work.

- e) Applicable GST shall be released to the vendor upon compliance of following: -
- i. Vendor declaring such Invoice in his GSTR-1 and the same is available to BHEL in FORM GSTR-2A/2B.
 - ii. Material Receipt Certificate (MRC)/ Engineering Protocol
 - iii. Confirmation of payment of GST thereon by vendor on GSTN Portal
 - iv. Above is subject to receipt of goods / service and tax invoice thereof along with vendor declaring invoice in his return and paying GST within timeline prescribed for availing ITC by BHEL.

09. EXTRA WORK RATES CURRENTLY BEING ADMITTED BY BHEL, PS-ER [Page-10, SPECIFIC TERMS AND CONDITIONS FOR SERVICES JOBS] shall be read as below: -

EXTRA WORK RATES CURRENTLY BEING ADMITTED BY BHEL, PS-ER

MAN-HOUR RATE FOR ELIGIBLE EXTRA WORKS: Single composite average labour man-hour rate, including overtime if any, supervision, use of tools and tackles and other site expenses and incidentals, consumables for carrying out any major rework/ repairs/ rectification/ modification/ fabrication as certified by site as may arise during the course of erection, testing, commissioning or extra works arising out of transit, storage and erection damages, payment, if found due will be at Rs 108/- per man hour.

PRICE SCHEDULE (UNPRICED)

PLEASE REFER

E-PROCUREMENT PORTAL <https://eprocurebhel.co.in>

PRICE SCHEDULE

PLEASE REFER

E-PROCUREMENT PORTAL <https://eprocurebhel.co.in>

ANNEXURE-A

1.0	<u>Suspension of Business dealings with Suppliers/ Contractors</u>
1.1	BHEL reserves the right to take action against Suppliers/ Contractors who fail to perform or indulge in malpractices, by suspending business dealings with them.
1.2	<p>Suspension of business dealings with Suppliers/ Contractors could be in the form of following: --</p> <p>a) Hold within the unit for specific item(s)/ material category(ies)/ type of work(s) for one year.</p> <p>b) Hold within the unit for all item(s)/ material category(ies)/ type of work(s) for two years</p> <p>c) Banning across BHEL for all items/ material category(ies)/ type of work(s) for three years.</p> <p>The Supplier may be either put on hold or banned, as detailed hereinafter on the basis of one or more of the category wise reasons as enumerated hereunder.</p>
1.3 1.3.1	<p>Hold within the unit for a specific item(s)/ material category(ies)/ type of work(s) shall be imposed in the following cases, if</p> <p>i) In the last three consecutive supplies of a specific material category, average quality rating, as provided in the supplier performance rating (SPR) as per SEARP, falls below 80% of the quality weightage. This is irrespective of supplies against PO(s) having single/ multiple delivery schedules.</p> <p>Note: Not applicable in cases for erection works of Power Sector Regions, where separate guidelines for evaluation of capacity of bidders is being followed.</p> <p>ii) Two consecutive delays, for reasons of delay attributed to the Supplier, in execution of the contracts where delay occurred is such that</p> <p>a) prescribed maximum LD time limits of the contracts is exceeded or</p> <p>b) delay period has equaled/ exceeded half the original delivery period specified in the contracts whichever among the above is earlier.</p> <p>iii)</p> <p>a) Overall SPR (Supplier Performance Rating) in that particular Unit in line with SEARP falls below 60% of the specific material category.</p> <p>b) Bids of contractors (in PS-MSX portal) shall not be considered (if average score of last six months falls 60% or below as per guidelines for evaluation of capacity of bidders formula).</p> <p>Note: – for (b), No specific period of hold shall be applicable.</p> <p>iv) Supplier works are under strike/ lockout for a period of more than three months.</p>

1.3.2	<p>Hold within the unit for all item(s)/material category(ies)/ type of work(s) shall be put in the following cases, if</p> <ul style="list-style-type: none"> i) Supplier tampers with tendering procedure affecting ordering process. ii) Supplier has misused BHEL documents/ drawings/ technical information or has breached the confidentiality agreement with BHEL. iii) after placement of order, Supplier fails to execute the contract. iv) within warranty period as per contract, Supplier continues to supply low/ less/ non-performing equipment/ services, repetitive failures, remains non-responsive. v) Wherever risk purchase clause (amounting to more than 5% of contract value) has been invoked. vi) After price bid opening but before placement of order, Supplier withdraws his offer or varies it in any manner within the validity period.
1.4	<p>Banning across BHEL shall be imposed in following cases, if</p>
1.4.1	<ul style="list-style-type: none"> i) –BLANK- ii) “Supplier is found to be responsible for submitting fake/ false/ forged documents, certificates, or information or misrepresentation/ wilful suppression of facts, or has resorted to unethical, illegal means or has forged BHEL documents, certificates etc. for securing business, meeting PQR or for enlistment in BHEL or with customers other than BHEL.” iii) In spite of warnings, the Supplier persistently violates or circumvents the provisions of labour laws/ regulations/ rules or other statutory requirements. iv) Supplier is found to be involved in cartel formation or in any other act so as to influence the bidding process or influence the price. v) The Supplier has indulged in malpractices or misconduct such as bribery, corruption and fraud, pilferage, coercion etc. vi) The Supplier is found guilty by any court of law for criminal activity/ offences involving moral turpitude in relation to business dealings. vii) Supplier is found to have obtained any internal information/ documentation of BHEL by unauthorized means. viii) The foreign Principals along with the representing Agent shall be banned together if information submitted by them about their precise relationship, commission/ remuneration etc. payable/ receivable and other particulars as asked by BHEL, as per the extant guidelines regarding dealing with Agents of Foreign Suppliers is found false/ incorrect, at any stage. ix) Supplier has substituted, damaged, failed to return, or unauthorizedly disposed off free issue materials/ tools etc. of BHEL.
1.4.2	<p>A Supplier can also be banned with the approval of Director (E, R&D) provided a direction to this effect has been received from the administrative ministry of the Government.</p>

Note: Above shall be applicable along with [Guidelines for “Suspension of Business dealings with Suppliers/ Contractors”](http://www.bhel.com) available in BHEL website <http://www.bhel.com>. These shall form part of tender documents.

ANNEXURE-B

Certificate by Chartered Accountant on letter head

This is to Certify that M/S ,
(hereinafter referred to as 'company') having its registered office at
..... is registered under MSMED Act 2006, (Entrepreneur
Memorandum No (Part—II)/ Udyam Registration Certificate No.
..... dtd:
....., Category: (Micro/Small/Medium)). (Copy enclosed).

Further verified from the Books of Accounts that the investment of the company as per the latest audited financial year..... as per MSMED Act 2006 is as follows:

1. **For Manufacturing Enterprises:** Investment in plant and machinery (i.e. original cost excluding land and building and the items specified by the Ministry of Small Scale Industries vide its notification No. S.O.1722(E) dated October 5, 2006:
Rs Lacs
2. **For Service Enterprises:** Investment in equipment (original cost excluding land and building and furniture, fittings and other items not directly related to the service rendered or as may be notified under the **MSMED** Act, 2006:
Rs Lacs
3. **For Enterprises** (having EM-II Certificate/ valid NSIC Certificate or Udyog Aadhar Memorandum): Investment in plant and machinery or equipment is Rs..... Lacs and turnover is Rs. Lacs (as notified in MSME notification no. S.O. 2119 (E) dated 26.06.2020)
4. **For Enterprises** (Udyam registered under Udyam Registration Portal): Investment in plant and machinery or equipment is Rs..... Lacs and turnover is Rs. Lacs (as notified in MSME notification no. S.O. 2119 (E) dated 26.06.2020)

(Strike off whichever is not applicable)

The above investment of RsLacs is within permissible limit of RsLacs forMicro / Small/ Medium (*Strike off which is not applicable*) Category under MSMED Act 2006.

Or

The enterprise has been graduated upward from its original category (micro/small/medium) (*strike off which is not applicable*), the enterprise shall maintain its prevailing status till expiry of one year from the close of year of registration, as notified vide S.O. No. 2119 (E) dated 26.06.2020 & S.O. 2347 (E), dated 16.06.2021 published in the gazette notification dated 26.06.2020 & 16.06.2021 by Ministry of MSME.

Or

The enterprise has been reverse-graduated from its original category (micro/small/medium) (*strike off which is not applicable*), the enterprise will continue in its present category till the closure of the financial year and it will be given the benefit of the changed status only with effect from 1st April of the financial year following the year in which such change took place, as notified vide S.O. No. 2119 (E) dated 26.06.2020 & S.O. 2347 (E), dated 16.06.2021 published in the gazette notification dated 26.06.2020 & 16.06.2021 by Ministry of MSME.

Date:

(Signature)

Name:

Membership Number:

Seal of the Chartered Accountant

ANNEXURE-C

UNDERTAKING

(To be typed and submitted in the Letter Head of the Company/Firm of Bidder)

To,

(Write Name & Address of Officer of BHEL inviting the Tender)

Dear Sir/Madam,

Sub: DECLARATION REGARDING INSOLVENCY/ LIQUIDATION/ BANKRUPTCY PROCEEDINGS

Ref: NIT/Tender Specification No:

I/We,

_____ declare that, I/We am/are not under insolvency resolution process or liquidation / BIFR or Bankruptcy Code Proceedings (IBC) as on date, by NCLT or any adjudicating authority/authorities, which will render us ineligible for participation in this tender.

**Sign. of the Authorised Signatory
(With Name, Designation and Company seal)**

Place:

Date:

DECLARATION FOR RELATION IN BHEL

(To be typed and submitted in the Letter Head of the Company/Firm of Bidder failing which the offer of Bidder is liable to be summarily rejected)

To,

(Write Name & Address of Officer of BHEL inviting the Tender)

Dear Sir,

Sub: **Declaration for relation in BHEL**

Ref: 1) NIT/Tender Specification No:,

I/We hereby submit the following information pertaining to relation/relatives of Proprieter/Partner(s)/Director(s) employed in BHEL.

Tick (✓) any one as applicable:

1. The Proprietor, Partner(s), Director(s) of our Company/Firm DO NOT have any relation or relatives employed in BHEL

OR

2. The Proprietor, Partner(s), or Director(s) of our Company/Firm HAVE relation/relatives employed in BHEL and their particulars are as below:

(i)

(ii)

Signature of the Authorized Signatory

Note:

1. Attach separate sheet, if necessary.
2. If BHEL Management comes to know at a later date that the information furnished by the Bidder is false, BHEL reserves the right to take suitable against the Bidder/Contractor.

FORMAT FOR SEEKING CLARIFICATION

(To be typed and submitted in the Letter Head of the Company/Firm of Bidder)

To,

(Write Name & Address of Officer of BHEL inviting the Tender)

Dear Sir,

Sub: **Request for Clarification**

Ref: 1) NIT/Tender Specification No:,
2) All other pertinent issues till date

Sl No	Reference clause of Tender Document	Existing provision	Bidder's query	BHEL's clarification
1				
2				
3				

Yours faithfully,

(Signature, date & seal of Authorized Representative of the Bidder)

FORMAT FOR DETAILS OF BIDDER

NAME OF BIDDER	
ADDRESS OF BIDDER	
Company Registration Number*	
Name of Partners / Directors	
Bidder Type Indian/ Foreign*	
City*	
State*	
Country*	
Postal Code*	
PAN/TAN Number*	
Company's Establishment Year	
Company's Nature of Business*	
Company's Legal Status* {limited company/undertaking/joint venture/partnership/other}	
Company Category* {micro unit as per MSME/small unit as per MSME/medium unit as per MSME/ UAN as per Udyog Aadhaar Memorandum/ Udyam Registration No. / Ancillary unit/project affected person of this company/SSI/ other} Relevant documents to be submitted as applicable.	
Enter Company's Contact Person Details Title(Mr. / Mrs. / Ms. / Dr. / Shri)*	
Contact Name*	
Date Of Birth*	
Correspondence Email* (Correspondence Email ID can be same as your Login ID. All the mail correspondence will be sent only to the Correspondence Email ID.)	
Designation	
Phone*	
FAX NO.	
Mobile*	

Form-1 (Format for local content)

**DECLARATION REGARDING MINIMUM LOCAL CONTENT IN LINE WITH
REVISED PUBLIC PROCUREMENT (PREFERENCE TO MAKE IN INDIA), ORDER 2017
DATED 04TH JUNE, 2020 AND SUBSEQUENT ORDER(S)**

(To be typed and submitted in the Letter Head of the Entity/Firm providing certificate as applicable)

To,

(Write Name & Address of Officer of BHEL inviting the Tender)

Dear Sir,

Sub: Declaration reg. minimum local content in line with Public Procurement (Preference to Make in India), Order 2017-Revision, dated 04th June, 2020 and subsequent order(s).

Ref.: 1) NIT/Tender Specification No:,
2) All other pertinent issues till date

We hereby certify that the items/works/services offered by.....
(Specify the name of the organization here) has a local content of _____ % and this meets the local content requirement for '**Class-I local supplier**' / '**Class II local supplier**' ** as defined in Public Procurement (Preference to Make in India), Order 2017-Revision dated 04.06.2020 issued by DPIIT and subsequent order(s).

The details of the location(s) at which the local value addition is made are as follows:

- | | |
|----------|----------|
| 1. _____ | 2. _____ |
| 3. _____ | 4. _____ |

...
...
...

Thanking you,
Yours faithfully,

(Signature, Date & Seal of Authorized Signatory of the Bidder)

**** Strike out whichever is not applicable.**

Note:

1. Bidders to note that above format Duly filled & signed by authorized signatory, shall be submitted along with the techno-commercial offer.
2. In case the bidder's quoted value is in excess of Rs. 10 crores, the authorized signatory for this declaration shall necessarily be the statutory auditor or cost auditor of the company (in the case of companies) or a practising cost accountant or practicing chartered accountant (in respect of suppliers other than companies).
3. In the event of false declaration, actions as per the above order and as per BHEL Guidelines shall be initiated against the bidder.

FORM – 2

DECLARATION REGARDING COMPLIANCE TO RESTRICTIONS UNDER RULE 144 (xi) OF GFR 2017

(To be submitted in the bidder's letter head)

To,

(Write Name & Address of Officer of BHEL inviting the Tender)

Dear Sir,

Sub: Declaration regarding compliance to Restrictions under Rule 144 (xi) of GFR 2017

Ref: 1) NIT/Tender Specification No:,
2) All other pertinent issues till date

I have read the clause regarding restrictions on procurement from a bidder of a country which shares a land border with India and on sub-contracting to contractors from such countries. I certify that _____ *(specify the name of the organization here)*, is not from such a country / has been registered with the Competent Authority** *(attach valid registration by the Competent Authority, i.e., the Registration Committee constituted by the Dept. for Promotion of Industry and Internal Trade (DPIIT))*; and will not sub-contract any work to a contractor from such countries unless such contractor is registered with the Competent Authority. *(attach relevant valid registration, if applicable)*

I hereby certify that we fulfil all requirements in this regard and is eligible to be considered.

Thanking you,
Yours faithfully,

(Signature, Date & Seal of Authorized Signatory of the Bidder)

**** Strike out whichever is not applicable.**

Note: Bidders to note that in case above certification given by a bidder, whose bid is accepted, is found to be false, then this would be a ground for immediate termination and for taking further action in accordance with law and as per BHEL guidelines.

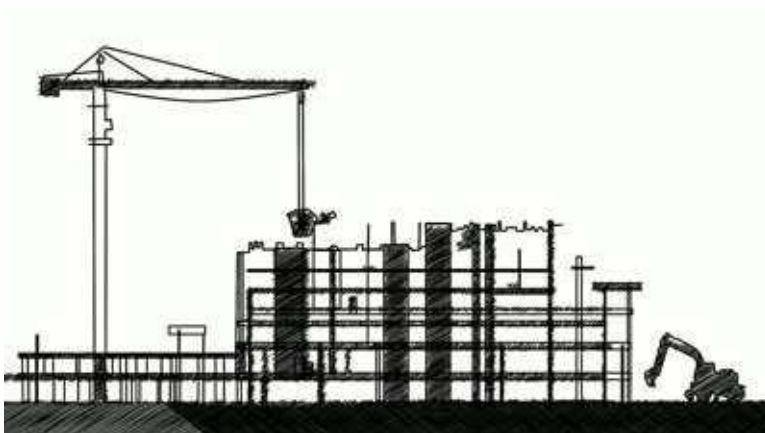

HEALTH, SAFETY and ENVIRONMENT PLAN

For

SITE OPERATIONS

By

SUB-CONTRACTORS

POWER SECTOR- EASTERN REGION

 PS-ER	HEALTH, SAFETY AND ENVIRONMENT PLAN FOR SUB-CONTRACTORS (GENERAL)	Doc. No.: HSEP:14-ER
		Rev.: 01
		Date: 08.05.20
		Page 2 of 170

DOCUMENT ISSUE SHEET

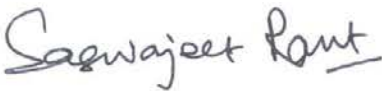
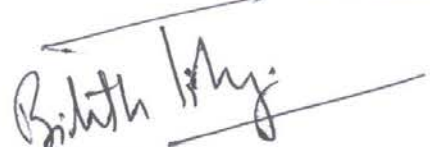
	PREPARED BY	APPROVED BY
NAME	Saswajeet Rout	Bishwanath Tirkey
DESIGNATION	Senior Engineer (HSE), PSER-HQ, Kolkata	Addl. GM (HSE), PSER-HQ, Kolkata
SIGNATURE		
ISSUED BY: Saswajeet Rout, Sr. Engineer (HSE), PSER-HQ, Kolkata		
ISSUED TO: All sites of BHEL-PSER		
COPY NO: E-Copy		
DATE OF ISSUE: 08.05.2020		

THIS PLAN SUPERSEDES THE STANDARD HSE PLAN

 PS-ER	HEALTH, SAFETY AND ENVIRONMENT PLAN FOR SUB-CONTRACTORS (GENERAL)	Doc. No.: HSEP:14-ER
		Rev.: 01
		Date: 08.05.20
		Page 3 of 170

HSE PLAN FOR SITE OPERATIONS BY BHEL'S SUBCONTRACTORS AT A GLANCE

BEFORE START	SIGNING OF MOU	
	Agree to comply to HSE requirement- Statutory and BHEL's	Agree to accept BHEL's decision on release of 1.5% (as specified in the contract) of Gross bill Amount or part thereof or otherwise (non-release), based on our HSE performance as evaluated by BHEL during the execution period
PLAN	HSE ORGANISATION	
	Manpower	HSE Roles and responsibilities
	<ul style="list-style-type: none"> • 1 (one) safety officer for every 300 workers or part thereof • 1(one) safety-supervisor for every 150 workers • 1(one) safety-steward/ supervisor for every 50 workers As per Cl. 7.1	<ul style="list-style-type: none"> • All employees as per 7.2.1 • Site In-charge & Package In-charges- As per clause 7.2.2 • Safety officer- As per clause 7.2.3
HSE Planning		
for Man, Machinery / Equipment/ Tools & Tackles		
PROVIDE	HSE INFRASTRUCTURE	
	<ul style="list-style-type: none"> • PPEs • Drinking Water • Washing Facilities • Latrines and Urinals • Provision of shelter for rest • Medical facilities 	<ul style="list-style-type: none"> • Canteen facilities • Labor Colony • Emergency Vehicle • Pest Control • Scrapyard • Illumination • Crèches (if required)
TRAIN	HSE TRAINING , AWARENESS & PROMOTION	
	Training <ul style="list-style-type: none"> • Induction training • Height work and other critical areas • Tool Box talk & Pep Talk • Job Specific Training 	Awareness & Promotion <ul style="list-style-type: none"> • Posters & Signage • Emergency Contact/Information Display • Banner • Competition & Awards
COMMUNICATE	HSE COMMUNICATION	
	Incident Reporting <ul style="list-style-type: none"> • Accident- Fatal, Major & Minor • Property damage • Near Miss Safety Performance Reporting	Event Reporting <ul style="list-style-type: none"> • Celebrations • Training • Medical camp • Motivational Activities

 PS-ER	HEALTH, SAFETY AND ENVIRONMENT PLAN FOR SUB-CONTRACTORS (GENERAL)	Doc. No.: HSEP:14-ER
		Rev.: 01
		Date: 08.05.20
		Page 4 of 170

EXECUTE SAFELY	SAFETY DURING WORK EXECUTION	
	PERMIT TO WORK Height work (above 2 meters), Hot Work, Heavy Lifting, Confined Space, Radiography, Excavation (More than 1.22 meters), Lockout / Tag out	
	OPERATIONAL CONTROL	
	<ul style="list-style-type: none"> • Welding, Gas Cutting Grinding • Rigging, Signaling • Cylinder- Storage & Movement • Demolition work • T&Ps • Chemical Handling • Electrical works • Painting 	<ul style="list-style-type: none"> • Fire • Scaffolding • Height work • Working Platform • Excavation / Civil Work • Ladder • Lifting • Hoisting appliance • Hard Barricading
	HOUSE KEEPING	
	WASTE MANGEMENT	
	TRAFFIC MANAGEMENT	
	ENVIRONMENTAL CONTROL	
	EMERGENCY PREPAREDNESS AND RESPONSE PLANNING	
	HSE AUDITS & INSPECTION	
<ul style="list-style-type: none"> • Daily Checks • Inspection of Height work • Inspection of PPEs • Inspection of T & Ps 	<ul style="list-style-type: none"> • Inspection of Cranes & Winches • Inspection of Welding and Gas cutting • Inspection of elevators etc. 	
CHECKS	HSE PERFORMANCE EVALUATION PARAMETERS	
	PENALTY for NON CONFORMANCE Refer Clause 16 Incremental penalty For repeated violation by the same person, the penalty would be double of the previous penalty For repeated fatal incident in the same contract / package, incremental penalty to be imposed. The subcontractor will pay 2 times the penalty compared to the previously paid in case there are repeated cases of fatal incidents under the same subcontractor for the same package in the same unit.	
	COMPENSATION TO ACCIDENT VICTIMS Refer Clause 17 Employee Compensation Act, 1922 Other Acts and Guidelines relevant to employee compensation	
NON CONFORMANCE		



HEALTH, SAFETY AND ENVIRONMENT PLAN
FOR
SUB-CONTRACTORS
(GENERAL)

Doc. No.: HSEP:14-ER

Rev.: 01

Date: 08.05.20

Page 5 of 170

ORGANIZATION OF THIS DOCUMENT

- **GENERAL SECTION**

- **SECTION A:**
MAIN REQUIREMENTS APPLICABLE IN FULL

- **SECTION B:**
SPECIAL REQUIREMENTS

- **ANNEXES**



**HEALTH, SAFETY AND ENVIRONMENT PLAN
FOR
SUB-CONTRACTORS
(GENERAL)**

Doc. No.: HSEP:14-ER

Rev.: 01

Date: 08.05.20

Page 6 of 170

CONTENTS

S. No.	Description	Page No.
GENERAL		
1	PURPOSE	9
2	SCOPE	9
3	OBJECTIVES AND TARGETS	10
4	REFERENCES	11
5	HEALTH, SAFETY & ENVIRONMENT POLICY	12
	MEMORANDUM OF UNDERSTANDING	13
6	TERMS & DEFINITIONS	14
SECTION-A		
7	HSE ORGANIZATION	17
7.1	DEPLOYMENT (NUMBERS, QUALIFICATIONS & EXPERIENCE)	17
7.2	HSE RESPONSIBILITIES	19
8	PLANNING BY SUBCONTRACTOR	23
8.1	MOBILISATION OF MACHINERY/EQUIPMENT/TOOLS	23
8.2	MOBILISATION OF MANPOWER BY SUBCONTRACTOR	24
8.3	PROVISION OF PPEs	25
8.4	ARRANGEMENT OF INFRASTRUCTURE	26
9	HSE TRAINING & AWARENESS	32
10	HSE PROMOTION – SIGNAGE, POSTERS, COMPETITIONS, AWARDS ETC	34
11	HSE COMMUNICATION & PARTICIPATION	35
12	INCIDENT INVESTIGATION & CORRECTIVE ACTION	36
13	SAFETY DURING WORK EXECUTION	37
13.1	HSE SYSTEMS & PROCEDURES	37
13.2	WORK PERMIT SYSTEM	39
13.3	ACTIVITY SPECIFIC SAFETY REQUIREMENTS	40
13.4	ENVIRONMENTAL CONTROL	46
13.5	HOUSEKEEPING	47



**HEALTH, SAFETY AND ENVIRONMENT PLAN
FOR
SUB-CONTRACTORS
(GENERAL)**

Doc. No.: HSEP:14-ER

Rev.: 01

Date: 08.05.20

Page 7 of 170

S. No.	Description	Page No.
13.6	WASTE MANAGEMENT	47
13.7	TRAFFIC MANAGEMENT	48
13.8	EMERGENCY PREPAREDNESS & RESPONSE	50
13.9	CONTROL OF DOCUMENTS	50
13.10	CONTROL OF RECORDS	50
14	HSE INSPECTION	51
15	HSE PERFORMANCE	54
16	HSE PENALTIES FOR NON-COMPLIANCE	55
17	OTHER REQUIREMENTS	56
18	INTERNAL & EXTERNAL HSE AUDITS	56
19	HSE REVIEW	57
20	FORMATS USE	58
	<i>FORMATS</i>	
SECTION B		
	ESTABLISHMENT OF COMMON FACILITIES / INFRASTRUCTURE	
	SHARED FACILITIES	
ANNEXES		
	ANNEXURE-1	
	ANNEXURE-2	
	ANNEXURE-3	
	ANNEXURE-A: ACTIVITY SPECIFIC REQUIREMENTS FOR SAFETY	
	ANNEXURE-B: HSE PRECAUTIONS FOR ADVERSE CLIMATES & WEATHER CONDITIONS	
	ANNEXURE-C: FIRE EXTINGUISHER REQUIREMENTS	
	ANNEXURE-D: SPECIFICATIONS	
	RECORD OF REVISIONS	

GENERAL



POWER SECTOR

**HEALTH, SAFETY AND ENVIRONMENT PLAN
FOR
SUB-CONTRACTORS
(GENERAL)**

Doc. No.: HSEP:14-ER

Rev.: 01

Date: 08.05.20

Page 9 of 170

1. PURPOSE

- 1.0** The purpose of this HSE Plan is to provide for the systematic identification, evaluation, prevention and control of general workplace hazards, specific job hazards, potential hazards and environmental impacts that may arise from foreseeable conditions during installation and servicing of industrial projects and power plants.
- 1.1** This document shall be followed by BHEL's Sub-Contractors at all installation and servicing sites. In case BHEL has contractual HSE obligations towards customer, this document will be followed in conjunction with (BHEL's) customer specific requirements, ensuring that applicable systems, controls and checks of both are implemented in letter and spirit.
- 1.2** In case the customer has any specific requirement, the same is to be fulfilled but may not include financial inclusion.
- 1.3** This document shall be followed unless otherwise mentioned in TCC (technical condition of contract) or elsewhere in NIT or contract documents. This supersedes all HSE clauses in GCC.
- 1.4** Although every effort has been made to make the procedures and guidelines in line with statutory requirements, in case of any discrepancy relevant statutory guidelines must be followed.

2. SCOPE

The document is applicable on all activities and assets including managerial, supervisory, professional, technical, clerical and other workers including contract laborers; and equipment operating under the control of BHEL's Subcontractors at all installation / servicing activities of BHEL Power Sector as per the relevant contractual obligations.



POWER SECTOR

**HEALTH, SAFETY AND ENVIRONMENT PLAN
FOR
SUB-CONTRACTORS
(GENERAL)**

Doc. No.: HSEP:14-ER

Rev.: 01

Date: 08.05.20

Page 10 of 170

3. OBJECTIVES

The HSE Plan reflects that BHEL places high priority upon the Occupational Health, Safety and Environment at workplaces. The Sub-contractor shall:

Health & Safety

- Prevent injury and ill health of all persons at site ('Persons' refers to all personnel including managerial, supervisory, professional, technical, clerical and other workers including contract laborers)

Environment

- Prevent pollution to environment and ensure protection of environment taking into account interested party concern and conservation of resources and reduction of wastage

Legal Requirements

- Comply at all times with the relevant statutory and contractual HSE requirements.

Planning & Resources

- Ensure that all work planning takes into account all persons that may be affected by the work.
- Ensure timely provision of resources to facilitate effective implementation of HSE requirements.

Competency, Training & Awareness

- Provide trained, experienced and competent personnel. Ensure medically fit personnel only are engaged at work.
- Provide all personnel with adequate information, instruction, training and supervision on the safety aspect of their work.

Maintenance of Equipment

- Ensure fitness testing of all T&Ps. Lifting appliances like cranes, chain pulley blocks etc. are certified by competent authority.

Safety during Operations

- Provide and maintain plant, places and systems of work that are safe and without risk to health and the environment.
- Effectively control, co-ordinate and monitor the activities of all personnel on the Project sites including subcontractors in respects of HSE.
- Establish effective communication on HSE matters with all relevant parties involved in the Project works.

HSE Improvement

- Capture the data of all incidents including near misses, process deviation etc. Investigate and analyze the same to find out the root cause
- Ensure timely implementation of correction, corrective action.
- Ensure continual improvement in HSE performance



POWER SECTOR

**HEALTH, SAFETY AND ENVIRONMENT PLAN
FOR
SUB-CONTRACTORS
(GENERAL)**

Doc. No.: HSEP:14-ER

Rev.: 01

Date: 08.05.20

Page 11 of 170

GOALS AND TARGETS

- ❖ To achieve “Zero Incident at Site” (LTI)
- ❖ 100% compliance of all legal/statutory requirements related to HSE.
- ❖ 100% Health, Safety and Environmental Induction training attendance for all workers.
- ❖ 100% High Risk activities to be carried out only after approved Method Statement, HIRA / Aspect-Impact / JSA / OCP and Permit to Work are implemented.
- ❖ 100% PPEs compliance in high and medium risk activities.
- ❖ 100% monitoring of all Work Areas
- ❖ 100% detection of non-conformities in work area and 100% closure within specified time
- ❖ 100% incident (near miss, minor, major, other) reporting, recording and reviewing for corrective actions.
- ❖ Regular Safety Reviews to assess HSE program compliance and 100% closure of any recognized gaps to continually improve safety management and incident prevention.

4. REFERENCES

1. ALL CONTRACTUAL HSE REQUIREMENTS INCLUDING THIS DOCUMENT
2. ALL APPLICABLE ACTS, RULES & REGULATIONS
3. BHEL POWER SECTOR HSE MANAGEMENT SYSTEM
 - I. HSE PROCEDURES (13.1.1)
 - II. WORK PERMITS (See Clause 13.1.2)
 - III. OPERATIONAL CONTROL PROCEDURES (See Clause 13.1.3)
 - IV. FORMATS (See Clause 21)
4. BHEL CORPORATE STANDARD PPE GUIDELINES
5. RELEVANT INDIAN STANDARDS FOR SAFETY (See Annexure 02)

(Note: Wherever, the date or revision number of a document is not mentioned, latest revision is implied)



POWER SECTOR

**HEALTH, SAFETY AND ENVIRONMENT PLAN
FOR
SUB-CONTRACTORS
(GENERAL)**

Doc. No.: HSEP:14-ER

Rev.: 01

Date: 08.05.20

Page 12 of 170

5. BHEL HEALTH, SAFETY & ENVIRONMENT POLICY:

In BHEL, Health, Safety and Environment (HSE) responsibilities are driven by our commitment to protect our employees and people we work with, community and environment. BHEL believes in zero tolerance for unsafe work/non-conformance to safety and in minimizing environmental footprint associated with all its business activities. We commit to continually improve our HSE performance by:

- Developing safety and sustainability culture through active leadership and by ensuring availability of required resources.
- Ensuring compliance with applicable legislation, regulations and BHEL systems.
- Taking up activities for conservation of resources and adopting sound waste management by following Reduce/Recycle/Reuse approach.
- Continually identifying, assessing and managing environmental impacts and Occupational Health & Safety risks of all activities, products and services adopting approach based on elimination/substitution/reduction/control.
- Incorporating appropriate Occupational Health, Safety and Environment criteria into business decisions, design of products & systems and for selection of plants, technologies and services.
- Imparting appropriate structured training to all persons at workplace and promoting awareness amongst customers, contractors and suppliers on HSE issues.
- Reviewing periodically this policy and HSE Management Systems to ensure its relevance, appropriateness and effectiveness.
- Communicating this policy within BHEL and making it available to interested parties.

Atul Sobti
Chairman & Managing Director



POWER SECTOR

**HEALTH, SAFETY AND ENVIRONMENT PLAN
FOR
SUB-CONTRACTORS
(GENERAL)**

Doc. No.: HSEP:14-ER

Rev.: 01

Date: 08.05.20

Page 13 of 170

6. TERMS AND DEFINITIONS

6.0 INCIDENT

Work- related or natural event(s) in which an injury or ill health (regardless of severity) or fatality, damage to property/environment occurred, or could have occurred.

6.1 NEAR MISS

An incident where no ill health, injury, damage or other loss occurs, but it had a potential to cause, is referred to as "Near-Miss incident".

6.2 MAN-HOURS WORKED

The total number of employee hours worked by all employees including subcontractors working in the premises.

It includes managerial, supervisory, professional, technical, clerical and other workers including contract laborers.

Man-hours worked shall be calculated from the payroll or time clock recorded including overtime. When this is not feasible, the same shall be estimated by multiplying the total man-days worked for the period covered by the number of hours worked per day. The total number of workday for a period is the sum of the number of men at work on each day of period. If the daily hours vary from department to department separate estimate shall be made for each department and the result added together.

6.3 FIRST AID CASES (FAC)

First aid cases include:

1. Visit to a physician or a licensed health care professional solely for observation or counselling
2. Conduct of diagnostic procedures like X rays, blood test including the prescription medications used solely for diagnostic purposes (e.g. eye drops to dilate eyes)
3. Using a non-prescription medicine at non-prescription strength (for medication available in both prescription and non-prescription form as recommendation by a physician or other licensed health care professional to use a non-prescription medication at prescription strength is considered medical treatment for record keeping purposes);
4. Administering tetanus immunizations (other immunizations, such as Hepatitis B vaccine or rabies vaccine, are considered medical treatment);
5. Cleaning, flushing or soaking wounds on the surface of the skin;
6. Using wound coverings such as bandages, Band-Aids TM, gauze pads, etc.; or using butterfly bandages or Steri-Strips TM (other wound closing devices such as sutures, staples, etc., are considered medical treatment);
7. Using hot or cold therapy;
8. Using any non-rigid means of support, such as elastic bandages, wraps, non-rigid back belts, etc. (devices with rigid stays or other systems designed to immobilize parts of the body are considered medical treatment for record-keeping purposes);



POWER SECTOR

**HEALTH, SAFETY AND ENVIRONMENT PLAN
FOR
SUB-CONTRACTORS
(GENERAL)**

Doc. No.: HSEP:14-ER

Rev.: 01

Date: 08.05.20

Page 14 of 170

9. Using temporary immobilization devices while transporting an accident victim (e.g., splints, slings, neck collars, back boards, etc.).
 10. Drilling of a fingernail or toenail to relieve pressure, or draining fluid from a blister;
 11. Using eye patches;
 12. Removing foreign bodies from the eye using only irrigation or a cotton swab;
 13. Removing splinters or foreign material from areas other than the eye by irrigation, tweezers, cotton swabs or other simple means;
 14. Using finger guards;
 15. Using massages (physical therapy or chiropractic treatment are considered medical treatment for recordkeeping purposes); or
 16. Drinking fluids for relief of heat stress.
- No other treatments are considered first aid.

6.4 MEDICAL TREATMENT CASES (MTC)

An incident involved with an injury or illness that needs medical attention beyond First-aid as per 6.3 above.

6.5 Dangerous Occurrence is defined as:

- (1) Collapse or failure of lifting appliances or hoist or conveyors or other similar equipment/machine;
- (2) Collapse or failure of a crane, derrick, winch, hoist or other appliance used in raising or lowering persons or goods or any part thereof, or the overturning of a crane;
- (3) Explosion or fire causing damage to the structure of any room or place in which persons are employed, or to any machine or plant, resulting in the complete suspension of ordinary work;
- (4) Electrical short circuit or failure of electrical machinery, plant or apparatus, attended by explosion or fire, causing structural damage involving its stoppage or disuse;
- (5) Explosion of a receiver or container used for the storage at a pressure greater than atmospheric pressure of any gas or gases (including air) or any liquid or solid resulting from the compression of gas;
- (6) Collapse in whole or part from any cause whatsoever of any roof, wall, floor, Structure or foundation forming part of the construction site in which persons are employed;
- (7) Total or partial collapse of any overburden, face, tip or embankment on the Construction site;
- (8) The overturning of, or collision with any object by any bulldozer, dumper, excavator, grader, lorry or shovel loader, or any mobile machine used for the handling of any substance on the construction site.

6.6 **Fire:** Except Dangerous occurrence, any incident involving fire.

6.7 **Property Damage:** Except Dangerous Occurrences and Fire, any incident of property (materials, building, equipment etc) getting damaged.

6.8 TYPE OF INCIDENT / ACCIDENT & THEIR REPORTING:

The categories of Incident / accident are as follows:

Non-Reportable Cases or NON-LTI: (Including First-aid cases as per 6.3 and MTC as per 6.4)

Minor: In this case the injured person resumes duty within 48 hours of incident.



POWER SECTOR

**HEALTH, SAFETY AND ENVIRONMENT PLAN
FOR
SUB-CONTRACTORS
(GENERAL)**

Doc. No.: HSEP:14-ER

Rev.: 01

Date: 08.05.20

Page 15 of 170

Reportable Cases (LTI or Loss Time Injury Cases):

Major: In this case the injured person is disable for 48 hours or more and is not able to perform his duty. (as per IS 3786). It includes fatality.

All incidents must be reported orally immediately and in writing within 24 hours of time of incident. However, in case of fatality, it shall be reported to the statutory authority within prescribed timeline through proper channel. Internal reporting shall be done within 6 hours of time of the incident

6.9 TOTAL REPORTABLE FREQUENCY RATE

Frequency rate is the number of Reportable Lost Time Injury (LTI) per one Million Man hours worked. Mathematically, the formula read as:

$$\frac{\text{Number of Reportable LTI}}{\text{Total Man Hours Worked}} \times 1,000,000$$

6.10 SEVERITY RATE

Severity rate is the Number of days lost due to Lost Time Injury (LTI) per one Million Man hours worked. Mathematically, the formula reads as:

$$\frac{\text{Days lost due to LTI}}{\text{Total Man Hours Worked}} \times 1,000,000$$

6.11 FREQUENCY SEVERITY INDEX (FSI)

Frequency Severity Index, $FSI = \sqrt{FR * SR / 1000}$

6.12 INCIDENCE RATE

Incidence Rate is the Number of LTI per one thousand manpower deployed. Mathematically, the formula reads as:

$$\frac{\text{Number of LTI} \times 1000}{\text{Average number of manpower deployed}}$$

6.13 JOB SAFETY ANALYSIS

A job safety analysis (JSA) is a procedure which helps integrate accepted safety and health principles and practices into a particular task or job operation. In a JSA, each basic step of the job is to identify potential hazards and to recommend the safest way to do the job. Other terms used to describe this procedure are job hazard analysis (JHA) and job hazard breakdown.



POWER SECTOR

**HEALTH, SAFETY AND ENVIRONMENT PLAN
FOR
SUB-CONTRACTORS
(GENERAL)**

Doc. No.: HSEP:14-ER

Rev.: 01

Date: 08.05.20

Page 16 of 170

6.14 SAFETY WALK

It's a walk (conducted periodically) by an official through a portion or whole of a site as an HSE officer, noting down HSE observations, speaking to concerned workmen and supervisor on observation, recording and reporting to in charges of agencies, getting the same rectified with personal follow up - to send out a strong message on Management's commitment to safety.

6.15 HEAVY & COMPLEX LIFTING

A heavy and complex lifting activity includes:

1. Lifting above 50 Tons
2. Tandem Lifting using multiple cranes
3. Total load exceeding 75% of capacity of crane
4. Lift of unusual difficulty or geometry or rigging
5. Lift over operating units
6. Any other lift as decided by site HSE / Erection

In any case, Job Safety Analysis to be carried out for any lift above 5 Tons.

6.16 SAFETY COMMITTEE

As per the BOCW, Safety Committee shall be constituted if there are more than five hundred or more construction workers are employed at any site. As per the Factories Act, 1948 it is for 250 workers. It shall be represented by equal number of representatives of employer and construction workers.

6.17 NIGHT WORK

Work conducted after sunset when only a fraction of total manpower is available

Section-A

Main Requirements

(Applicable in Full)



POWER
SECTOR

HEALTH, SAFETY AND ENVIRONMENT PLAN
FOR
SITE OPERATIONS
(SECTION-A)

Doc. No.: HSEP:14-
ER
Rev.: 01
Date: 08.05.20
Page 18 of 170

7. HSE ORGANISATION

7.1 DEPLOYMENT

7.1.1 Minimum Number (Availability per contract / package per Working Shift)

7.1.1.1 HSE Officer	7.1.1.2 HSE Supervisor	7.1.1.3 HSE Steward / Observer
1 per 300 workers or part thereof as a minimum or as mandated by applicable legal requirements, whichever more stringent	1 per 150 workers or part thereof	1 per 50 workers or part thereof

7.1.1.4 The safety officers shall be engaged directly by the sub-contractor, whereas safety supervisors and safety stewards may be from the agencies engaged by the sub-contractor.

7.1.1.5 Deployment Plan:

7.1.1.5.1 These shall be minimum one HSE officer along with HSE supervisor and HSE steward in the aforesaid ratio for every shift for each unit of Boiler/ESP/Power House & TG/ Chimney/ Whole of Cooling Tower.

7.1.1.5.2 For Civil works and other BOP items, deployment shall be broadly as specified in the above table. But BHEL shall finally approve the deployment based on nature and volume of jobs, Risks and hazards associated etc.

7.1.1.5.3 The deployment plan of Safety manpower at various locations shall be submitted to BHEL for approval by subcontractor

BHEL reserves the right to demand more safety personnel than what is stipulated here and change the deployment pattern



POWER
SECTOR

HEALTH, SAFETY AND ENVIRONMENT PLAN
FOR
SITE OPERATIONS
(SECTION-A)

Doc. No.: HSEP:14-ER

Rev.: 01

Date: 08.05.20

Page 19 of 170

7.1.2 QUALIFICATION & EXPERIENCE

All Degrees/ Diplomas shall be recognized by State Council for Technical Education & Vocational Training (SCTE & VT) / All India Council for Technical Education (AICTE) / University

7.1.2.1 HSE Officer	7.1.2.2 HSE Supervisor	7.1.2.3 HSE Steward / Observer
<p>A.</p> <p>i. Recognized degree in any branch of Engg. or Tech. or Architecture with practical experience of working in a building or other construction work in supervisory capacity for a period of not less than two years, or Recognized diploma in any branch of Engg. or Tech with practical experience of working in a building or other construction work in supervisory capacity for a period of not less than five years.</p> <p>ii. Recognized degree or diploma in Industrial safety</p> <p>ii. (Preferably) have adequate knowledge of the language spoken by majority of the workers at the construction site.</p> <p style="text-align: center;">Alternatively:</p> <p>B.</p> <p>Graduation Degree in Science with Physics & Chemistry and degree or diploma in Industrial Safety (from any Indian institutes recognized by AICTE or State Council of Tech. Education of any Indian State) with practical experience of working in a building, plant or other construction works (as Safety Officer, in line with Indian Factories Act, 1958) for a period of not less than five years.</p>	<p>As a minimum, (s)he shall possess:</p> <p>A recognized graduation Degree in Science (with Physics & Chemistry) or a recognized diploma in Engg. or Tech. with:</p> <p>a. Minimum Two years of practical experience in construction work environment and</p> <p>b. Should possess requisite skills to deal with construction safety & fire related day-to-day issues.</p>	<p>As a minimum, (s)he shall possess:</p> <p>1. Class XII pass certificate and</p> <p>2. Trained in fire-fighting as well as in safety / occupational health related subjects, with:</p> <p>a. Minimum two year of practical experience in construction work environment and</p> <p>b. Should have adequate knowledge of the local language spoken by majority of the workers at the construction site.</p>

7.1.3 HSE IN-CHARGE

In case there are more than one HSE Officers with any subcontractor, one of them, who is senior most by experience (in HSE discipline), may be designated as HSE In-Charge. Duties & responsibilities of such person shall be commensurate with that of relevant statute and primarily to coordinate with top management of Client and subcontractors.



**HEALTH, SAFETY AND ENVIRONMENT PLAN
FOR
SITE OPERATIONS
(SECTION-A)**

Doc. No.: HSEP:14-ER
Rev.: 01
Date:08.05.20
Page 20 of 170

7.1.4 AVAILABILITY AND PENALTY FOR NON-DEPLOYMENT:

Subcontractor shall ensure physical availability of safety personnel at the place of specific work location including where Height Work Permit is required/granted. No work shall be started in any area until above safety personnel & concerned Site Engineer of subcontractor are physically deployed at site.

The Subcontractor shall prepare an organization chart identifying the areas of operations, responsibilities and reporting structure of all safety personnel and submit the same to BHEL.

The subcontractor shall deploy sufficient safety officers, supervisors and safety-stewards, as per numbers & qualifications mandated in this Section since mobilization of first batch of manpower and add more in proportion to the added strength in work force. Any delay in deployment will attract a penalty at following rates:

Non-deployment of HSE Officer	–	Rs 50000 per man-month
Non-deployment of HSE Supervisor	–	Rs 30000 per man-month
Non-deployment of HSE Steward	–	Rs 20000 per man-month

Penalty shall be collected for the period of non-availability of safety personnel after allowing a grace period of 15 days for finding a replacement.

7.1.5 QUALIFICATION OF CRANE & WINCH OPERATORS, DRIVERS etc.:

The Crane and Winch Operators, Drivers, Riggers and other professionals deployed shall be qualified and experienced, and have valid license for the class of vehicle / machinery as applicable. The subcontractor shall certify competence of these persons.in writing as and when they join.

Crane/Winch operator should have certificate on subject course or owner experience certificate in letterhead.

7.1.6 In case the statutory requirements i.e. State or Central Acts and / or Rules as applicable like the Building and Other Construction Workers' Regulation of Employment and Conditions of Service- Act,1996 or State Rules (wherever notified), the Factories Act, 1948 or Rules (wherever notified), etc. are more stringent than above clarifications, the same shall be followed.

7.1.7 **BILLING:** Deployment of Safety manpower as per this clause **shall be** a billable item.

7.1.8 The Subcontractor shall verify & authenticate credentials of the HSE personnel detailed in this Section and furnish Bio-Data/Resume / Curriculum Vitae of the safety personnel as above for BHEL / Owner's approval, at least 1 month before the mobilization. The Subcontractor, whenever required, shall arrange submission of original testimonials / certificates of their Safety personnel, to BHEL / Owner (for verification/scrutiny, etc.)

7.1.9 Prior approval of CVs by BHEL for Safety Officer and Safety Supervisor is mandatory, however BHEL has right to check suitability of Safety Stewards as well.

 <p>POWER SECTOR</p>	HEALTH, SAFETY AND ENVIRONMENT PLAN FOR SITE OPERATIONS (SECTION-A)	Doc. No.: HSEP:14-ER
		Rev.: 01
		Date:08.05.20
		Page 21 of 170

7.2 HSE RESPONSIBILITIES

The subcontractors shall communicate the HSE responsibilities as indicated in this section to relevant employees in written Form and ensure awareness of the same

7.2.1 ALL EMPLOYEES

1. To be aware of, get involved in and ensure implementation of all HSE related Systems and Procedures including but not limited to:
 - a) BHEL HSE Management System including HSE Procedures and OCPs
 - b) Work Permit System
 - c) Emergency Preparedness Response Plans
 - d) Contractual HSE requirements
 - e) Legal Requirements
 - f) Penalty System
 - g) Training requirements
2. To ensure that the persons engaged in respective area follow the safety rules like using appropriate PPEs.
3. To keep track of repetitive minor or major incident observation/ report and submit to BHEL.
4. To prepare HIRA / JSA as required and submit to BHEL for verification.
5. To record all incidents including near miss and report to BHEL.
6. To adopt safe working practices at all times and act as role model for Safety
7. To take immediate corrective action actions in case any non-conformity is observed on product / process / system with respect to Occupational Health, Safety and Environment.
8. In case any particular activity / work has extremely high consequential risk or high environmental impact, same shall be brought to the notice of BHEL Package In-charge before starting the work.
9. To interfere/ stop work as & when identified unsafe.
10. To maintain & promote improved level of house-keeping all the time at site.
11. To support/co-operate with audit team members as & when safety audits are carried out.
12. To involve in investigation, if any incident occurs in his work area.
13. To participate in safety promotional programmes.
14. To attend the safety committee meeting, if member/ invitee
15. To ensure that only fit T&Ps and qualified persons are engaged for all activities.
16. Shall ensure that person working above 2.0 meter should use Safety Harness tied to a life line/stable structure.
17. Shall ensure that materials are not thrown from height. Cautions to be exercised to



**POWER
SECTOR**

**HEALTH, SAFETY AND ENVIRONMENT PLAN
FOR
SITE OPERATIONS
(SECTION-A)**

Doc. No.: HSEP:14-
ER

Rev.: 01

Date:08.05.20

Page 22 of 170

prevent fall of material from height.

18. Shall ensure that all T&Ps engaged are tested for fitness and have valid certificates from competent authorities.

7.2.2 SITE IN –CHARGE & PACKAGE IN-CHARGES OF SUBCONTRACTOR

1. All requirements as per 7.2.1
2. **Shall ensure fulfillment of HSE requirements of BHEL contract as given in this document.**
3. Shall engage qualified safety manpower as per this document at all times.
4. Shall adhere to the rules and regulations mentioned in this document, practice very strictly in his area of work in consultation with his concerned engineer and the safety coordinator.
5. Shall screen all workmen for health and competence requirement before engaging for the job and periodically thereafter as required.
6. Shall ensure that all the workers are engaged after undergoing induction training.
7. Shall arrange for all necessary PPEs like safety helmets, belts, full body harness, shoes, face shield, hand gloves etc. before starting the job. Shall ensure that no working men /women carry excessive weight more than stipulated in Factory Rule Regulation R57.
8. Shall ensure that provisions stipulated in contract Labor Regulation Act 1970, Chapter V C.9, canteen, rest rooms/washing facilities to contracted employees at site.
9. Shall report all incidents (Fatal/Major/Minor/Near Miss) to the Site engineer /HSE officer of BHEL.
10. Shall conduct Safety Walks and safety inspections, and act as a role model for Safety.
11. Shall ensure that Horseplay is strictly forbidden.
12. Shall ensure that adequate illumination is arranged during night work.
13. Shall ensure that all personnel working under subcontractor are working safely and do not create any Hazard to self and to others.
14. Shall ensure display of adequate signage/posters on HSE.
15. Shall ensure that mobile phone is not used by workers while working.
16. Shall ensure conductance of HSE audit, mock drill, medical camps, induction training and training on HSE at site.
17. Shall ensure full co-operation during Client/External /Customer HSE audits.
18. Shall ensure submission of look-ahead plan for procurement of HSE equipment's and PPEs as per work schedule.
19. Shall ensure adequate valid fire extinguishers are provided at the work site.
20. Shall ensure availability of sufficient number of toilets /restrooms and adequate drinking water at work site and labor colony.
21. Shall ensure adequate emergency preparedness
22. Site In-charge also involve in the induction training so as to share knowledge of some incident and guide the worker to perform work safely.
23. Shall ensure power source for hand lamps shall be maximum of 24 v.
24. Shall ensure temporary fencing should be done for open edges if Hand – railings and Toe-



**POWER
SECTOR**

**HEALTH, SAFETY AND ENVIRONMENT PLAN
FOR
SITE OPERATIONS
(SECTION-A)**

Doc. No.: HSEP:14-
ER

Rev.: 01

Date:08.05.20

Page 23 of 170

guards are not available.

25. Shall be responsible for the periodic testing of T&Ps (winches / crane /hydra/tools/equipment so on.) and Pressure Vessels as per applicable codes and submit report to BHEL
26. Shall be member of site HSE committee and attend all meetings of the committee

7.2.3 HSE OFFICER OF SUBCONTRACTOR

1. All requirements as per 7.2.1
2. Carry out safety inspection of Work Area, Work Method, Men, Machine & Material, P&M and other tools and tackles.
3. Facilitate HIRA and Aspect/Impact Study in the area and ensure control measures.
4. Highlight the requirements of safety through Tool-box / other meetings.
5. Help concerned HOS to prepare Job Specific instructions for critical jobs.
6. Maintain record and conduct investigation of all incident/dangerous occurrences & recommend appropriate safety measures.
7. Advice & co-ordinate for implementation of HSE permit systems, OCPs & MPs.
8. Convene HSE meeting & minute the proceeding for circulation & follow-up action.
9. Plan procurement of PPE & Safety devices and inspect their healthiness.
10. Report to BHEL on all matters pertaining to status of safety and promotional programmes at site level.
11. Encourage raising Near Miss Report on safety along with, improvement initiatives on safety.
12. Facilitate administration of First Aid
13. Facilitate screening of workmen and safety induction.
14. Conduct fire Drill and facilitate emergency preparedness
15. Design campaigns, competitions & other special programs to promote safety in the workplace.
16. Notify non-conformance to safety norms observed during site visits / site inspections.
17. Recommend to Site In-charge, immediate discontinuance of work until rectification, of such situations warranting immediate action in view of imminent danger to life or property or environment.
18. To decline acceptance of such PPE / safety equipment that do not conform to specified requirements.

7.2.4 HSE SUPERVISOR OF SUBCONTRACTOR

1. All requirements as per 7.2.1
2. To assist Safety officer

7.2.5 HSE STEWARD / OBSERVER OF SUBCONTRACTOR

1. All requirements as per 7.2.1
2. To monitor allotted area for Safety violations, take required action and inform the concerned Safety Supervisor / Officer

 POWER SECTOR	HEALTH, SAFETY AND ENVIRONMENT PLAN FOR SITE OPERATIONS (SECTION-A)	Doc. No.: HSEP:14-ER
		Rev.: 01
		Date:08.05.20
		Page 24 of 170

3. To assist Safety Officer and Safety Supervisor

7.2.6 HSE DOCUMENTS, SYSTEMS & PROCEDURES:

BHEL shall provide the subcontractor soft copies of all applicable HSE Procedures, Work Permits, Operational Control Procedures, Formats and any other instructions required for the implementation of HSE Management System before commencing operations at site. Subcontractor shall ensure the availability of the same.

7.2.7 IMPORTANT SITE EHS RULES RESULTING IN POSSIBLE EXPULSION FROM SITE

- ❖ Pre-employment Medical fitness is compulsory for all workers.
- ❖ EHS induction is mandatory for all new workers, supervisor and engineers, subcontractor managers etc.
- ❖ No visitors are allowed for site visit without safety induction.
- ❖ **Mandatory PPEs are**
 - ✓ Safety helmet,
 - ✓ Hard toe safety shoes,
 - ✓ Safety glasses
 - ✓ Reflective vest
 - ✓ Full/half sleeve (at least 4-inch-long) shirt
 - ✓ Full length pant/trousers for male and preferably Salwar Kameez for female
- ❖ **Zero Tolerance Safety Rules**
 - Violation of Fall protection / not anchoring & wearing safety harness above 6 feet,
 - Work without PTW
 - Child labor at site
- ❖ Restricted Use of cell phone in the working zone, operating vehicle/crane and at height. Encourage the people not to bring mobile phones inside the project premises.
- ❖ All vehicle being used at site to be in good condition in all respect.
- ❖ All electrical installations should have individual 30 mA ELCBs
- ❖ **Fighting:** Fighting anywhere on the Project site, including in parking areas, is strictly forbidden; violators will be barred from site and possibly subjected to legal action by local authorities.
- ❖ **Horseplay:** Running, pushing, practical jokes, and other horseplay are forbidden on the project site, including in parking areas.
- ❖ **Gambling:** Gambling on the Project site is not permitted
- ❖ **Alcohol & Drugs:** Intoxication or possession of alcohol or illegal drugs is strictly forbidden.
- ❖ **Weapons:** Possession of weapons on the Project site is strictly prohibited
- ❖ **Asbestos Material:** No asbestos material is allowed to use in Project Site
- ❖ **Hair:** Anyone working on site property with scalp hair longer than the top of his/her shoulders must tie-up and restrains the hair within the hard hat or coveralls, shirt or jacket collar.
- ❖ **Jewelry:** Loose necklaces, dangling earrings and bracelets shall not be worn when working on the Project site.



**POWER
SECTOR**

**HEALTH, SAFETY AND ENVIRONMENT PLAN
FOR
SITE OPERATIONS
(SECTION-A)**

Doc. No.: HSEP:14-
ER

Rev.: 01

Date:08.05.20

Page 25 of 170

- ❖ **Contact Lens:** While the site does not prohibit the wearing of contact lens, BHEL Project does not recommend their use.
- ❖ **Use of Empty Drums:** Use of empty drums to climb up and work is banned. Proper stool/ ladder/ stage required to be used if intended to work at height.
- ❖ Projects must comply in full with all applicable EHS local and national legislation. In circumstances where there is a conflict between local or national legislation and client requirements, the higher (more protective) requirement must prevail.
- ❖ All persons working on suspended scaffolds/cradles/gondolas must wear and use appropriate fall prevention equipment so as to protect them effectively at all times when they are at risk from any failure of any part of the scaffold/cradle/gondola, including its suspension system
- ❖ **Construction Trucks/Vehicles**
 - ✓ Vehicles must be equipped with proper seat belts for driver and passengers. All persons riding in vehicles must be advised of the requirement that seat belts are to be used whenever the vehicles are being operated.
 - ✓ The subcontractor is responsible for assuring the overall safe condition of vehicles assigned to its projects.
 - ✓ The speed limit on the project site is a maximum of 20 Km/hr.
 - ✓ Any person found operating or driving in a reckless or careless manner without regard for the safety of other employees or the general public will be immediately removed for the equipment they were operating and permanently prohibited from operating or driving any equipment on the project.
 - ✓ Any mobile equipment found to be unsafe or defective must be immediately removed from service and sent for repair or replacement. The subcontractor must ensure that the proper repairs have been made prior to putting the equipment back into service.
- ❖ **Construction Material Handling Heavy Equipment**
 - ✓ No equipment may be modified without equipment manufacturer's authorization.
 - ✓ Rollover Protective Structures must be provided for all equipment as required.
 - ✓ Seat belts must be provided and used by operators of all equipment that has a Rollover Protective Structure.
 - ✓ All bi-directional equipment must be equipped with an operable horn that must be used as needed when the machinery is moving in either direction.
 - ✓ All bi-directional equipment must also have an operable alarm in addition to the horn.
 - ✓ All equipment must be provided with a multi-purpose (class A, B, and C) fire extinguisher mounted in an easily accessible location.
 - ✓ Braking systems, controls, safety devices must be maintained in effective operating condition.
 - ✓ The operator must inspect the equipment at the beginning of the shift and test for acceptable



**POWER
SECTOR**

**HEALTH, SAFETY AND ENVIRONMENT PLAN
FOR
SITE OPERATIONS
(SECTION-A)**

Doc. No.: HSEP:14-
ER

Rev.: 01

Date:08.05.20

Page 26 of 170

- ✓ operation as per the equipment's manufacturer's instructions. Inspections must be documented and filed.
- ✓ Only qualified personnel must be allowed to operate equipment. Qualification must be documented and filed.

In case any worker violates any of the EHS rules identified by BHEL as above, following punitive action shall be taken:

First Offence	Second Offence	Third Offence	Fourth Offence
<i>Oral warning</i>	<i>Gate Pass Punched</i>	<i>Gate pass punched (second)</i>	<i>Gate Pass Punched(third) and person sent out of the gate</i> <i>Photo of concerned worker to be displayed on Notice boards and prominent locations.</i>

BHEL has the right to send out such person even earlier than fourth offence after considering the severity of the offence and/or the persons track record related to following general/EHS rules.

BHEL reserves right to expel even concerned supervisor or engineer as well in case of repeat of such cases of indiscipline.

Note:

The appellate authority in this case shall be the BHEL Site In-charge whose decision shall be final on the matter and binding on all parties.

8. PLANNING FOR HSE

A. Identifying Hazards / Risks & Aspects / Impacts and implementing control measures

1. Subcontractor shall identify all OHS Hazards and Risks applicable to all activities in scope as per *HSEP01: HSE Procedure for OHS Hazards and Risks*, and plan & implement the required control measures.
2. Subcontractor shall identify all Environmental Aspects and Impacts applicable to all activities in scope as per *HSEP02: HSE Procedure for Environmental Aspects and Impacts*, and plan & implement the control measures.

B. Register of Regulations:

Subcontractor shall prepare a register of applicable rules and regulations in the scope as per

 POWER SECTOR	HEALTH, SAFETY AND ENVIRONMENT PLAN FOR SITE OPERATIONS (SECTION-A)	Doc. No.: HSEP:14-ER
		Rev.: 01
		Date:08.05.20
		Page 27 of 170

HSEP03: HSE Procedure for Register of Regulations and plan to ensure compliance.

The detailed plans and registers in A and B to be submitted to BHEL for review and approval within 60 days of start of work at site.

Note: The plans above are dynamic and shall be periodically reviewed as per BHEL requirement.

8.1 MOBILISATION OF MACHINERY / EQUIPMENT / TOOLS

1. Subcontractor shall furnish to BHEL, the Test Certificates issued by the jurisdictional competent persons of machinery, equipment and other T&Ps to be deployed at site, before deployment. BHEL reserves the right to disallow the same if found non-conforming to HSE / legal requirements
2. As a further measure to ensure that machinery, equipment and tools being mobilized to the construction site are fit for purpose and are maintained in safe operating condition and comply with legislative and owner requirement, inspection shall be arranged by in-house expert / competent authority (preferable) for acceptance. **(Report Format: HSEP:14-F15)**
3. **The equipment considered for this purpose shall include all those in the T&P list in the tender document. Conventional Hydra crane with carriage in front shall not be permitted. Other models like FX or TRX series of Escorts or equivalent shall be permitted.**
4. In the course of work, the subcontractor shall notify the BHEL Engineer, of his intention to bring on to site any equipment or any container, with liquid or gaseous fuel or other substance which may create a hazard.
5. The Engineer shall have the right to prescribe the condition under which such equipment or container may be handled and used during the performance of the works and the subcontractor shall strictly adhere to such instructions.
6. The Engineer shall have the right to inspect any construction tool and to forbid its use, if in his opinion it is unsafe. No claim due to such prohibition will be entertained.
7. Following items should be only ISO certified and not more than 2 yr. of purchase
 - i. Chain pulley block
 - ii. Wire rope slings
 - iii. Grinding machine and wheel and buffing wheel
 - iv. Gas cutting equipment
8. Following equipment should not be more than 5 Yr. old
 1. Welding machine
 2. Vibrator Machine
 3. Concrete cutter
 4. DB/Electrical panel
9. **Office Infrastructure** - subcontractor shall arrange a computer / Laptop with Network



**POWER
SECTOR**

**HEALTH, SAFETY AND ENVIRONMENT PLAN
FOR
SITE OPERATIONS
(SECTION-A)**

Doc. No.: HSEP:14-
ER

Rev.: 01

Date:08.05.20

Page 28 of 170

connection, chair and table for HSE Staff to facilitate HSE reporting and recordkeeping.

8.2 MOBILISATION OF MANPOWER

1. As a measure to ensure that manpower being mobilized to the construction site is fit and competent for safe working, screening arrangement shall be made by the sub-contractor to ensure fulfillment of contractual as well as legislative requirement by:
 - i. Ensuring the required qualification/ training/ certification/ license and experience for the job as per Section 7 of this document & applicable legal requirements
 - ii. **Medical Checkup:** Examination of medical fitness shall be conducted through qualified medical professional for all workers to be deployed. (Record: Format No. HSEP14:F02). For height workers, height phobia test to be carried out as qualification criteria.
 - iii. **Induction Training:** Induction training of all workers to be ensured as per clause 9.1 and HSEP04: *HSE Procedure for Training & Awareness* (Record: Format No. HSEP14:F03)

Only on successfully meeting above criteria, permanent gate passes to be issued.

2. The subcontractor shall strictly adhere to the maximum daily working hours and other requirements as per applicable laws and shall not engage any employee below 18 years of age.
3. The subcontractor shall take special care of the employees affected with occupational diseases under rule 230 and schedule II of BOCW Rules. The employees not meeting the fitness requirement should not be engaged for such job.
4. Ensure that the regulatory requirements of excessive weight limit (to carry / lift / move weights beyond prescribed limits) for male and female workers are complied with.
5. System for Issue of Gate Passes to authorized personnel only shall be ensured at site
6. The subcontractor shall keep accurate and updated records of all manpower preferably in soft form
7. The subcontractor shall ensure appropriate infrastructure for workers as per Clause 8.4.

8.3 PROVISION OF PPEs

1. Adequate numbers of Personnel Protective Equipment (PPEs), will be made available at site & their effectiveness and regular use by all will be ensured
2. The PPEs shall conform to the relevant standards as listed in Annexure 02, and bear ISI mark.
3. The following matrix recommends usage of minimum PPEs against the respective job. For details, the respective OCPs to be referred.



**POWER
SECTOR**

**HEALTH, SAFETY AND ENVIRONMENT PLAN
FOR
SITE OPERATIONS
(SECTION-A)**

Doc. No.: HSEP:14-
ER
Rev.: 01
Date:08.05.20
Page 29 of 170

Sl. No	Type of work	Suggested PPEs
1	Work at height	Double lanyard full body harness with rope grab (as applicable), retractable Fall arrestor (specific cases), Safety nets (single / double)
2	Concrete and asphalt mixing	Nose mask, hand glove, apron, gum boot, goggles
3	Welders/ Grinders/ Gas cutters	Welding/face screen, apron, hand gloves, nose mask and ear muffs if noise level exceeds 90dB. Helmet fitted with welding shield is preferred for welders, safety goggles
4	Stone/ concrete breakers	Ear muffs, safety goggles, hand gloves
5	Electrical Work	Rubber hand glove, Electrical Resistance shoes, Arc-flash resistant suit.
6	Insulation Work	Respiratory mask, Hand gloves, safety goggles
7	Grit/Sand blasting	Blast suit, blast helmet, respirator, leather gloves, safety goggles
8	Painting	Plastic gloves, Respirators (particularly for Spray painting)
9	Radiography	As per BARC guidelines
10	General	Helmets, Safety Shoes Reflective vests, ear plugs, nose masks, safety goggles

4. The exact PPEs required for a particular task shall be chosen to ensure there are multiple lines of defense against accident or injury. All applicable safety precautions for a job shall be ensured notwithstanding the duration or perceived importance of the task.
5. Additionally, the BHEL safety officer may demand additional PPEs based on specific requirement
6. The applicability of PPEs shall be as per the concept of Hierarchy of controls, i.e.:
Elimination->Substitution->EngineeringControls->AdministrativeControls-PPEs
7. Relying solely on PPEs without other applicable controls to be strictly avoided.
8. The issuing agency shall maintain register for issue and receipt of PPEs (Format No. HSEP: 14-F06A). All the PPEs shall be checked for quality before issue and shall be periodically re-checked. The users shall be advised to check the PPEs themselves for any defect before putting on. The defective ones shall be replaced.
9. The body harnesses shall be serial numbered.
10. All worker should wear reflecting Jacket during both shift Day/Night.
11. Where workers are employed in sewers and manholes, which are in use, the subcontractor shall ensure that the manhole covers are opened and ventilated at least for an hour before the workers are allowed to get into manhole, and the manholes so opened shall be cordoned off with suitable railing and provided with warning signals or boards to prevent incident to the public
12. Besides the PPEs mentioned above, the persons shall use helmet, safety shoe and reflective vest at all times. The visitors shall use Helmet and any other PPEs as



POWER
SECTOR

HEALTH, SAFETY AND ENVIRONMENT PLAN FOR SITE OPERATIONS (SECTION-A)

Doc. No.: HSEP:14-ER
Rev.: 01
Date:08.05.20
Page 30 of 170

deemed appropriate for the area of work.

13. Following color scheme for Helmets to be maintained:

- a. Workmen: Yellow
- b. Safety staff: Green or white with green band
- c. Electrician: Red
- d. Others including visitors: White

14. The Helmets shall have logo or name (abbreviation of agency name permitted) affixed or printed on the front along with the person's gate pass no. & blood group. An awarded worker shall have reflective logo

8.4 ARRANGEMENT OF INFRASTRUCTURE

The subcontractor is responsible for ensuring and maintaining the required HSE infrastructure at site as described in this Section

8.4.1 DRINKING WATER

1. Drinking Water Storage Tanks shall be provided and maintained at suitable places at different elevations / locations to ensure easy accessibility. The tank/container shall be kept on a platform at an elevation of at least 2 feet and should be covered:



2. **Construction and Quantity:** The design of Drinking Water Storage Tank (DWST) shall be submitted to BHEL for approval prior to initiating construction. Provision of 5 liter water daily for each worker to be maintained.
3. **Labelling:** DWST should be labeled as "Drinking Water". Date of last cleaning, next due date shall be indicated on the container besides Date of source testing as per IS 10500.
4. Cleaning of the DWST shall be ensured at least once in a week. Mild cleaning detergents as used for cleaning vessels shall be applied and scrubbers (3M or equivalent) shall be used for removing scales and deposits on the inside surface. The tank shall be thoroughly cleaned with potable water only before it is refilled.
5. Suitability of the water source should be tested as per IS10500.
6. For all tanks containing water unsuitable for drinking, prominent "Do Not Drink" signage shall be pasted in English, Hindi and local language.
7. In Hot Work and other critical areas, drinking water shall be made available near the activity
8. Provision of supplying drinking water to height workers and those working in difficult to reach

 <p>POWER SECTOR</p>	HEALTH, SAFETY AND ENVIRONMENT PLAN FOR SITE OPERATIONS (SECTION-A)	Doc. No.: HSEP:14-ER
		Rev.: 01
		Date:08.05.20
		Page 31 of 170

areas shall be made available through dedicated personnel.

- 8.4.2 **PROVISION OF LATRINES AND URINALS AT SITE** (Ref: Interstate Migrant Workmen (Regulation & Employment and Act, 1979) read with The Inter-State Migrant Workmen (Regulation of employment and conditions of service) central rules, 1980 (PI refer rule no. 42)

LATRINES

1. Latrines shall be provided in every establishment on the following scale, namely: -
 - a. Where females are employed, there shall be at least one latrine for every 25 females;
 - b. Where males are employed, there shall be at least one latrine for every 25 males:

Provided that where the number of males or females exceeds 190, it shall be sufficient if there is one latrine for 25 males or females, as the case may be, up to the first 100, and one for every 30 thereafter

2. Every latrine shall be under cover and so partitioned off as to secure privacy, and shall have a proper door and fastenings.
3. Where workers of both sexes are employed there shall be displayed outside each block of latrine and urinal a notice in the language understood by the majority of the workers '**For Men Only**', or '**For Women Only**', as the case may be.
4. The notice shall also bear the figure of a man or of a woman, as the case may be.

URINALS

5. There shall be at least one urinal for male workers up to fifty and one for female up to fifty employed at a time:
6. Provided that where the number of male or female workmen, as the case may be, exceeds 500 it shall be sufficient if there is one urinal for every fifty females up to the first 500 and one for every 100 or part thereof thereafter.
7. The urinals shall be designed and located so as to ensure privacy.
8. In case a structure encompasses multiple floors, urinals shall be provided suitably for quick access
9. The latrines and urinals shall be conveniently situated and accessible to workers at all times at the establishment.
10. The latrines and urinals shall be adequately lighted and shall be maintained in a clean and sanitary condition at all times.
11. Latrines and urinals other than those connected with a flush sewage system shall comply with the requirements of the public health authorities.
12. Water shall be provided by the means of tap or otherwise so as to be conveniently accessible in or near the latrines and urinals.

8.4.3 WASHING FACILITIES

1. In every workplace, adequate and suitable facilities for washing shall be provided and maintained.
2. Separate and adequate cleaning facilities shall be provided for the use of male and female workers. Such facilities shall be conveniently accessible and shall be kept in clean and hygienic

 <p>POWER SECTOR</p>	HEALTH, SAFETY AND ENVIRONMENT PLAN FOR SITE OPERATIONS (SECTION-A)	Doc. No.: HSEP:14-ER
		Rev.: 01
		Date:08.05.20
		Page 32 of 170

condition and dully illuminated for night use.

3. Overalls shall be supplied by the subcontractor to the workmen and adequate facilities shall be provided to enable the painters and other workers to wash during the cessation of work.

8.4.4 PROVISION OF REST SHELTER FOR WOKERS

Proper Sheds & Shelters big enough to accommodate all possible workers shall be provided for workers to rest during break. Taking rest at height, in activity area and other hazardous locations shall not be allowed.

The drawing of such sheds shall be submitted to BHEL for approval before construction.

8.4.5 MEDICAL FACILITIES

Refer Section B for applicability of requirements pertaining to Clause 8.4.5.1

8.4.5.1 MEDICAL CUM FIRST-AID CENTER

- a) A medical center shall be setup at site with basic facilities for handling medical emergencies. The medical center shall be developed independently by BHEL/an agency as specified in the contract and run jointly by all agencies on proportionate sharing basis as stipulated in the contract.
- b) A qualified medical professional, not less than MBBS, shall be deployed at medical center as stipulated in the contract.(Part-time or full time as decided at the site).
- c) There shall be a full-time trained first aider and a nurse. Depending upon the working hours at the site, First-aider shall be deployed accordingly.
- d) The center shall have all articles as per Schedule IV of BOCW(Central) Rules'1998. In addition,, one Stokes basket stretcher shall be available.
- e) An ambulance shall be deployed for every 1000 persons along with trained driver and accessories as per schedule V of Central BOCW Rules'1998. Depending upon the working hours at the site, First-aider shall be deployed accordingly.
- f) The center shall be adequately equipped for Resuscitation, Immobilisation, Dressing, dealing with poisoning cases including snake and insect-bites and sufficient stock of emergency medicines as prescribed by the qualified medical professional as per point (b)

8.4.5.2 IMPORTANT

- g) If there is no specific mention of responsibility of deployment or setting up of any of the above facilities and operating expenses thereof, BHEL site management shall have the liberty to give this responsibility to any of the contractors on cost sharing basis.
- h) Medical waste shall be disposed as per prevailing legislation (Bio-Medical Waste –Management and Handling Rules, 1998)
- i) Every injury shall be treated, recorded and reported.
- j) All First Aid injuries shall be recorded as per Format No. HSEP:14-F17
- k) List of qualified first aiders and their contact numbers to be displayed at conspicuous places.



POWER
SECTOR

HEALTH, SAFETY AND ENVIRONMENT PLAN
FOR
SITE OPERATIONS
(SECTION-A)

Doc. No.: HSEP:14-
ER

Rev.: 01

Date:08.05.20

Page 33 of 170

8.4.5.3 FIRST AID

A. In addition to 8.4.5.1 & 2, The subcontractor with Boiler&ESP, TG, Civil shall:

1. Provide necessary first aid facilities for every work place.
2. Ensure availability of qualified First-aider throughout the working hours.
3. Every injury shall be treated, recorded and reported.
4. Refresher course on first aid shall be conducted as necessary.
5. List of qualified first aiders and their contact numbers to be displayed at conspicuous places.
6. All First Aid injuries shall be recorded as per Format No. HSEP:14-F17

B. FIRST AID BOX

1. The first aid box shall be maintained by first aider who shall always be readily available during the working hours of the work place.
2. **Details of First Aid Box:**
 - a) Details of contents of first aid box is given in **Annexure 03**. A slip of contents shall be pasted on the First Aid Box with following details:

Name, Quantity, Expiry Date, Checked by...

 - b) First Aider's name and contact no to be displayed on the box.
 - c) The first aid box shall be distinctly marked with a Green Cross on white background.
 - d) The box shall be properly secured with lock & key to avoid misuse
7. The first aid boxes should be placed at various locations so as to make them available within easy reach of hazardous activities and at the quickest possible time.
8. The subcontractor shall ensure that the Supervisors and Engineers are adequately trained for attending to any emergency.
9. Monthly inspection of First Aid Box to be conducted by the subcontractor as per Format no. HSEP:14-F01

8.4.5.4 HEALTH CHECK UP

The persons engaged at the site shall undergo health checkup as per the **Format no. HSEP:14-F02** before induction. The persons engaged in the following works shall additionally undergo regular health checkup using same Format at least once in a year:

Height workers	Drivers/crane operators/riggers	Confined space workers
Shot/sand blaster	Welding and NDE personnel	Any person referred by BHEL

8.4.5.4.1 HEIGHT PHOBIA TEST

1. The persons engaged in working at heights (above 2 meters) to be assessed for Height Phobia and associated conditions.
2. Such workers are to be allowed only on successful completion of this test, otherwise they shall be allocated ground based jobs. IDs / Height passes shall be issued to such workers.

8.4.6 PROVISION OF CANTEEN FACILITY



**POWER
SECTOR**

**HEALTH, SAFETY AND ENVIRONMENT PLAN
FOR
SITE OPERATIONS
(SECTION-A)**

Doc. No.: HSEP:14-
ER

Rev.: 01

Date:08.05.20

Page 34 of 170

Minimum or better facilities to be ensured as per BOCW (Rule 244) / Factories Act, specially taking care of the following:

1. Canteen facilities shall be provided for the workmen of the subcontractor inside the project site.
2. Proper cleaning and hygienic condition shall be maintained.
3. Proper care should be taken to prevent biological contamination.
4. Adequate drinking water should be available at canteen.
5. Fire extinguisher shall be provided inside canteen.
6. Regular health check-up and medication to the canteen workers shall be ensured.
7. Canteen waste to be disposed of in compliance with law
8. Domestic LPG cylinder shall not be used
9. Canteen should be periodically inspected using standard checklist finalized along with BHEL

8.4.7 PROVISION OF ACCOMMODATION / LABOR COLONY

1. The subcontractor shall provide to every workman (within fifteen days of the commencement of the employment of migrant workmen):
 - a) In case he is accompanied by any other member of his family, a suitable barrack so as to accommodate one room having at least a floor area of 10 square meters, a verandah and adequate additional covered space for cooking food as well as one common sanitary latrine, one common bathroom for every three such quarters; and
 - b) In case he is unaccompanied by any other member of his family, a suitable barrack so as to accommodate not more than ten such migrant workmen, having at least a floor area of not less than 6.5 square meters for each such migrant workman making use of the barrack, a verandah and adequate additional covered space for cooking food as well as one common sanitary latrine and one common bathroom for every ten such migrant workmen
2. Every quarter and the barrack shall be so constructed as to afford adequate ventilation, protection against heat, wind, rain and shall have smooth, hard and impervious floor surface.
3. The quarters or the barracks, as the case may be, shall be at a convenient distance from the establishment and shall have adequate supply of wholesome drinking water.
4. The area in which the quarters and/or barracks are located as well as the latrines and bathrooms provided therein shall be kept in a clean and sanitary condition at all times.
5. Regular housekeeping of the labor colony shall be ensured.
6. Availability of Bathing/ washing bay to be ensured



**POWER
SECTOR**

**HEALTH, SAFETY AND ENVIRONMENT PLAN
FOR
SITE OPERATIONS
(SECTION-A)**

Doc. No.: HSEP:14-
ER

Rev.: 01

Date:08.05.20

Page 35 of 170

7. Room ventilation and safe electrification to be ensured
8. MSDS of LPG shall be put up prominently and shall be included in the induction training also.
9. The labor colony shall be secure so that only authorized persons have access to it.
10. Availability of local market to be ensured by the Sub-contractor
11. A "Suggestion Register" shall be made available at the labor colony for workers. The feedback shall be reviewed on weekly basis and acted upon.
12. Labor colony shall be inspected fortnightly by Subcontractor Safety Officer & HR executive, and report submitted to BHEL as per Format No. HSEP:4-F16
13. **Facility of Crèches** – to be provided wherein more than fifty female workers are deployed
14. Provisions of Clause 8.4.1, 8.4.2 and 8.4.3 shall be applicable on labor colony as well

8.4.8 PROVISION OF EMERGENCY VEHICLE

Dedicated emergency vehicle shall be made available at workplace by subcontractor for evacuation of victim from site.

However, Ambulance shall be used exclusively for transporting victim to hospital

8.4.9 PEST CONTROL

Regular pest control should be carried out at all offices, mainly laboratories, canteen, labor colony and stores by the subcontractor.

8.4.10 SCRAPYARD

1. Scrapyard shall be developed by subcontractor to store metal scrap, wooden scrap, waste, hazardous waste.
2. Scrap/Waste shall be segregated as Bio-degradable and non-bio-degradable and stored separately.

8.4.11 ILLUMINATION

1. The subcontractor shall provide adequate lighting facilities e.g. flood lighting, hand lamps, area lights etc. to ensure adequate lighting at all work places & their approaches including passage ways as per IS: 3646 (Part-II) at all times. Indicative recommended values are given below:

S. No.	Location	Lux Level
A. Construction Site		
1	Outdoor areas like store yards, entrance and exit roads	20
2	Platforms	50
3	Entrances, corridors and stairs	100
4	General illumination of work area	150
5	Rough work like fabrication, assembly of major items	150



**POWER
SECTOR**

**HEALTH, SAFETY AND ENVIRONMENT PLAN
FOR
SITE OPERATIONS
(SECTION-A)**

Doc. No.: HSEP:14-
ER

Rev.: 01

Date:08.05.20

Page 36 of 170

6	Medium work like assembly of small machined parts	300
7	Fine work like precision assembly, precision measurements etc.	700
8	Sheet metal works	200
9	Electrical and instrument labs	450
B.	Office	
1	Outdoor area like entrance and exit roads	20
2	Entrance halls	150
3	Corridors and lift cars	70
4	Lift landing	150
5	Stairs	100
6	Office rooms, conference rooms, library reading tables	300
7	Drawing table	450
8	Manual telephone exchange	200

In case any area is not mentioned above, the applicable illumination for the same shall be specified by BHEL based on applicable standards and international norms

- Level of illumination shall be checked periodically using a calibrated lux meter and recorded for each work area on minimum weekly basis as per Format No. HSEP:14-F21
- Lamp (hand held) shall not be powered by mains supply but either by 24V or dry cells.
- Lamps shall be protected by suitable guards where necessary to prevent danger, in case of breakage of lamp.
- Emergency lighting provision for night work shall be made to minimize danger in case of main supply failure.

9. HSE TRAINING & AWARENESS

9.1 HSE INDUCTION TRAINING

- All persons entering into project site shall be given HSE induction training before being assigned to work, which shall be imparted through audio-visual medium and shall be of minimum 2-hour duration.
- Any single trainee batch size should not exceed 40.
- Proper safety wear & gear must be issued to all the workers being registered for the induction (i.e., Shoes/Helmets/Goggles/Leg guard/Apron etc.)
 - They must arrive fully dressed in safety wear & gear to attend the induction.
 - Any one failing to conform to this safety wear& gear requirement shall not qualify to attend.
- In-house induction training subjects shall include but not limited to:



**POWER
SECTOR**

**HEALTH, SAFETY AND ENVIRONMENT PLAN
FOR
SITE OPERATIONS
(SECTION-A)**

Doc. No.: HSEP:14-
ER
Rev.: 01
Date:08.05.20
Page 37 of 170

- i. Briefing of the Project details and importance of employee for the project and for the nation.
 - ii. Safety related cardinal rules, objectives and targets.
 - iii. Site HSE rules.
 - iv. Site HSE hazards and aspects.
 - v. First aid facility.
 - vi. Emergency Contact No. and procedures
 - vii. Details of Fire prevention and emergency response systems & procedures at site.
 - viii. Requirement of incident / near miss reporting by all.
 - ix. Accident case studies
 - x. Rules to be followed in the labor colony (if applicable)
5. Evaluation to be carried out after training and induction training to be repeated in case of failure of participant in evaluation
6. On completing subcontractor's in-house HSE induction, each employee shall sign an induction training form (format no. HSEP: 14-F03) to declare that he had understood the content and shall abide to follow and comply with safe work practices. They may only then be qualified to be issued with a personal I.D. card, for access to the work site (provided Health Checkup is over).

9.2 HSE TOOLBOX TALK

1. HSE Tool Box talk shall be conducted by frontline foreman/supervisor of subcontractor to specific work groups daily prior to the start of work. The agenda shall consist of the following:
 - i. Visual checkup of workers regarding health, any signs of fatigue, intoxication etc.
 - ii. Details of the job being intended for immediate execution.
 - iii. The relevant hazards and risks involved in executing the job and their control measures.
 - iv. Specific site condition to be considered while executing the job like high temperature, humidity, unfavorable weather etc.
 - v. Recent non-compliances observed.
 - vi. Appreciation of good work and warning for any unsafe acts done by any person.
 - vii. Any doubt clearing session at the end
2. Record of Tool box talk shall be maintained as per Format no. HSEP:14-F04

9.3 TRAINING ON HEIGHT WORK

Due to the large percentage of fall from height in incidents, training of minimum 2-hour duration on height work shall be imparted to all height workers by in- house / external faculty for every batch of new inductees. The training shall include following topics:

1. Inspection of work area, access and egress w.r.t height hazards
2. Use of PPEs; use of fall arrester, retractable fall arrester, life line, safety nets etc.
3. Safe climbing through monkey ladders.
4. Inspection of PPEs.
5. Medical fitness requirements.
6. Mock drill on rescue at height.
7. Dos & Don'ts during height work.



POWER
SECTOR

HEALTH, SAFETY AND ENVIRONMENT PLAN
FOR
SITE OPERATIONS
(SECTION-A)

Doc. No.: HSEP:14-
ER
Rev.: 01
Date:08.05.20
Page 38 of 170

8. Accident case studies

In case, above is organized by BHEL, proportionate cost shall be borne by subcontractors

9.4 HSE TRAINING DURING PROJECT EXECUTION

1. HSE training shall be arranged by subcontractor as per the need of the project execution and recommendation of BHEL.
2. The topics of the HSE training shall be as follows but not limited to:
 - i. Hazards identification and risk analysis & Identification of Environmental Aspects / Impacts
 - ii. Work Permit System
 - iii. Learning from past incidents
 - iv. First aid, Firefighting & Fire-warden training
 - v. EMS and OHSMS
 - vi. T & Ps fitness and operation
 - vii. Electrical & Chemical safety
 - viii. Welding, NDE & Radiological safety
 - ix. Material handling.
3. Safety awareness and on-the-job training programmes shall be carried out at site for all workers periodically. Periodicity to be decided by BHEL but shall be minimum once in six months
4. Penalty Training – In case of any incident, the involved person, group or agency shall undergo a penalty HSE training for a minimum period of 2 hrs or as decided by BHEL.
5. In case it is not possible to provide training to all workers at once, same shall be imparted in Batch-wise manner so as to cover all workers with specified periodicity.
6. An up-to-date record to be maintained with attendance of participants and trainers preferably in soft copy as per Format No. HSEP:14-F03.
7. Every employee of agency should be provided at least 2 hr. safety training in every month.

In case, above is organized by BHEL, proportionate cost shall be borne by subcontractors

10. HSE PROMOTION: SIGNAGE, POSTERS, COMPETITION, AWARDS ETC

10.1 DISPLAY OF HSE POSTERS AND BANNERS

Site shall arrange appropriate posters, banners, slogans in local/Hindi/English languages at work place.

10.2 DISPLAY OF HSE SIGNAGE

Appropriate HSE signage shall be displayed at the work area to enhance awareness of HSE workmen and passersby about the work going on and do's and don'ts to be followed.

10.3 COMPETITIONS ON HSE, AWARDS & REWARDS



**POWER
SECTOR**

**HEALTH, SAFETY AND ENVIRONMENT PLAN
FOR
SITE OPERATIONS
(SECTION-A)**

Doc. No.: HSEP:14-ER
Rev.: 01
Date:08.05.20
Page 39 of 170

1. Subcontractor shall arrange competitions (slogan, poster, essay etc.) on HSE for workers and employees from time to time (Safety day, World Environment Day etc. minimum one such function each month) and winners will be suitably awarded during the functions.
2. Subcontractor shall identify workers following good HSE practices and reward them from time to time as encouragement to follow good HSE practices.
3. Alternatively, if a common monthly function is organized at site, subcontractor shall participate in the same so that a minimum frequency of one such function per month is maintained.

10.4 HSE AWARENESS PROGRAMMES

Subcontractor shall arrange HSE awareness programmes periodically on different topics including medical awareness for all personnel working at site from time to time including officials involved in execution.

11. HSE COMMUNICATION AND PARTICIPATION

11.1 MONTHLY HSE REPORTING

1. HSE activities shall be reported to BHEL monthly as per Format no. HSEP: 14-F05. The reporting medium can be hard/soft as per BHEL requirement.
2. The period of reporting shall be 25th of the preceding month to 24th of the present month and report shall be submitted by the end of the calendar month or as conveyed by BHEL.
3. BHEL can modify the reporting requirements as per requirement

11.2 HSE EVENT REPORTING

1. Important HSE events like HSE Training, Mock / Fire/Rescue Drills, Medical camp etc. organized by subcontractor shall be reported to BHEL in detail with photographs
2. Celebration of important days like National Safety Day, World Environment Day etc. shall also be reported likewise.

11.3 HSE INCIDENT REPORTING

All incidents (near misses, property damage, first-aid cases, minor, major and fatal incidents) shall be reported to BHEL as they happen through SMS and Hard/Soft copy as per Format No. HSEP: 14-F22

11.4 HSE SUGGESTIONS

All workers and employees to be encouraged to provide suggestions for improvement in



**POWER
SECTOR**

**HEALTH, SAFETY AND ENVIRONMENT PLAN
FOR
SITE OPERATIONS
(SECTION-A)**

Doc. No.: HSEP:14-ER
Rev.: 01
Date:08.05.20
Page 40 of 170

Health, Safety & Environment at site. The suggestions to be recorded in a "Suggestions Register". Suggestions to be reviewed and those having potential of significant beneficial effects are to be implemented, and recognition / award to be given to the individual.

11.5 CLIENT COMMUNICATON

All HSE related communication from BHEL, customer / external statutory and regulatory agencies to be handled on priority. The relevant issues to be resolved in expeditious manner

11.6 RECORDS OF COMMUNICATON

Records of all communication and their responses as detailed above shall be maintained by subcontractor in hard / soft copy and produced when required.

12. INCIDENT REPORTING, INVESTIGATION & CORRECTIVE ACTION

1. A conducive environment for reporting of near misses and other incidents shall be developed at site through system of rewards etc.
2. Priority to be given to ensure medical treatment of the victim. Victim to be given immediate First Aid and transported to Medical Facility in a well-equipped Ambulance
3. All incidents, as they happen, shall be reported to BHEL immediately over phone/SMS/Whatsapp/mail and then in Format No. HSEP:14-F22 within 24 hrs. of occurrence. Immediate SMS shall be sent to concerned Package In-charge with following Details:

- a. Project & Customer Name:
- b. Subcontractor Name & Scope:
- c. Incident Area:
- d. Number of Injured / Fatalities:
- e. Date & Time of Accident:
- f. Incident Description in few lines:

No incident shall be hidden

4. Records of all incidents shall be maintained in hard / soft copy as per Format No. HSEP:14-F23.
5. For all incidents:
 - a. The incident area, equipment / tools involved, documents & records etc. shall be maintained as-it-is pending investigation
 - b. Root Cause Analysis (RCA) to be conducted and corresponding Corrective / Preventive Action (CAPA) ensured
 - c. Responsibility shall be assigned and action to be taken against the erring individual
 - d. In case presence of manufacturer of the equipment involved is required, subcontractor will arrange the same

 <p>POWER SECTOR</p>	HEALTH, SAFETY AND ENVIRONMENT PLAN FOR SITE OPERATIONS (SECTION-A)	Doc. No.: HSEP:14-ER
		Rev.: 01
		Date:08.05.20
		Page 41 of 170

e. All expenses pertaining to the RCA / CAPA shall be borne by the subcontractor

6. RCA and CAPA reports of all near misses and minor injuries shall be identified and report submitted to BHEL within 7 days of occurrence.
7. For incidents, where worker does not resume duty within 48 hours of occurrence, Joint investigation along with BHEL shall be conducted within 7 days, and CAPA ensured.
8. Corrective action shall be immediately implemented at the work place. Work shall be put on hold in the area till corrective actions are verified by BHEL
9. All incidents, their Root Cause Analyses and Corrective actions shall be recorded, and analyzed so as to identify weak areas and actions to be taken to reduce the incident trend.

13. SAFETY DURING WORK EXECUTION

13.1 HSE SYSTEMS AND PROCEDURES

BHEL Power Sector HSE Management System (HSEMS) shall be referred for controlling hazards, aspects, and carrying out HSE activities at site. Subcontractor shall get familiar with and follow the HSEMS documents provided by BHEL which include the follows:

13.1.1 HSE PROCEDURES:

All HSE Procedures defined in HSEMS, as referred in various sub-clauses of this Section as given in Annexure 01

13.1.2 PERMIT TO WORK (PTW) SYSTEM

1. The following activities shall be carried out by the subcontractor strictly after obtaining Permit to Work (PTW) from BHEL
 - i. General Work Permit (**Format No. HSEP14-FP01**)
 - ii. Height working (**Format No. HSEP14-FP02**)
 - iii. Hot working (**Format No. HSEP14-FP03**)
 - iv. Confined space Work (**Format No. HSEP14-FP04**)
 - v. Excavation more than 2-meter depth (**Format No. HSEP14-FP05**)
 - vi. Radiography / Radiation Work (**Format No. HSEP14-FP06**)
 - vii. Heavy / Complex / Critical Lifting Activity (**Format No. HSEP14-FP07**)
 - viii. Night / Holiday Work (**Format No. HSEP14-FP08**)
 - ix. Material Loading / Unloading Permit (**Format No. HSEP14-FP09**)
 - x. Grating / Safety Net / Safety Facility Removal Permit (**Format No. HSEP14-FP10**)
 - xi. Live Electrical Maintenance etc. - Lockout / Tag (**Format No. HSEP14-FP07**)



**POWER
SECTOR**

**HEALTH, SAFETY AND ENVIRONMENT PLAN
FOR
SITE OPERATIONS
(SECTION-A)**

Doc. No.: HSEP:14-
ER
Rev.: 01
Date:08.05.20
Page 42 of 170

2. The above list is not exhaustive. BHEL reserves right to introduce additional Permits or modify requirements for usage of existing Permits. The conditions for using the Permit are specified in the Format (General Requirements).
3. Where customer is having separate Work Permit System the same shall be followed in conjunction to ensure all activities and checks are covered in all systems.
4. Permit applicant shall apply for work permit of particular work activity at particular location before starting of the work along with Job Hazard Analysis.
5. All Permit signatories shall physically visit the work area and check that all the safety control measures necessary for the activity are in place. Only then the permit shall be issued.
 - a. Signatory shall physically visit the area of work and ensure all required safeguards before signing the Permit
 - b. Signatory shall periodically visit the area to confirm the availability of required safeguards throughout the currency of the permit
 - c. In case any Permit requirement is not available, work will be stopped till it is made available
6. Permit holder shall implement and maintain all control measures during the period of permit. The permit will be closed after completion of the work and submitted to BHEL.

13.1.3 Operational Control Procedures

1. All applicable OCPs (Operational Control Procedures) as identified from outcomes of HIRA, Aspect / Impact studies and BHEL inputs will be followed by subcontractor. This will be done as part of normal scope of work.
2. Illustrative list of such OCPs is given in Table 13.1 and same will be made available to subcontractor by BHEL during work execution at site.
3. In case any other OCPs are required or existing ones need to be modified in order to control the risks / impacts associated with any activity during the execution of work subcontractor shall prepare / update and follow the same with information to BHEL.

Table 13.1 - LIST of Reference OCPs

No.	Topic	No.	Topic	No.	Topic
0	General Safety	22	Steam blowing	44	Material preservation
1	Handling of chemicals	23	Working in confined area	45	Electro-resistance heating
2	Electrical safety	24	Operation of passenger lift, material hoists & cages	46	Blasting
3	Energy conservation	25	Vehicle/ Crane maintenance	47	Transformer charging
4	Welding and gas cutting operation	26	Radiography	48	Handling of battery system
5	Fire safety	27	Waste disposal	49	DG set
6	Use of hand tools	28	Handling & storage of mineral wool	50	Sanitary maintenance
7	First aid	29	Working at night	51	Piling rig operation



**POWER
SECTOR**

**HEALTH, SAFETY AND ENVIRONMENT PLAN
FOR
SITE OPERATIONS
(SECTION-A)**

Doc. No.: HSEP:14-
ER
Rev.: 01
Date:08.05.20
Page 43 of 170

8	Food safety at canteen	30	Computer operation	52	Passivation
9	Use of cranes	31	Storage in open yard	53	EDTA Cleaning
10	Storage and handling of gas cylinders	32	Drilling, reaming and grinding(machining)	54	Chemical cleaning of Pre boiler system
11	Manual arc welding	33	Stress relieving	55	Boiler Light up
12	Use of helmets	34	Hydraulic test	56	Rolling and Synchronization
13	Good house keeping	35	Trial run of rotary equipment	57	Loading of Unit
14	Safe excavation	36	Batching	58	Air compressor
15	Working at height	37	Cable laying/tray work	59	Hydra Operation
16	Filling of hydrogen in cylinder	38	Spray insulation	60	Duct/ Structure Preassembly
17	illumination	39	Compressor operation	61	Resumption of construction activities after lockdown and prevention of coronavirus infection during site operation
18	Handling and erection of heavy metals	40	Gas distribution test	61A	Prevention of Covid-19 infection in labour colony
19	Acid cleaning	41	Cleaning of Hotwell / Deaerator	62	Truss/ Structure fit-up & alignment
20	Oil flushing	42	Electrical maintenance		
21	Alkali boil out	43	O&M of control of AC plant & system		

13.2 ACTIVITY SPECIFIC REQUIREMENTS FOR SAFETY:

All Work shall be commenced only after taking the respective Work Permits (as applicable) and precautions as per relevant codes, systems and OCPs in order to ensure safe conditions throughout the duration of work. Additionally, activity specific safeguards as per this section shall be followed.

13.2.1 WORK AT HEIGHT:

- All work at height above 2 meter above ground level without complete platforms, handrails and other related fall protection shall require a work permit in the prescribed form. This shall require approval by the competent authority. The HSE officer of sub-contractors shall follow the checklist religiously by physically verifying the condition of the work area before recommending for approval.
- Prior to the start of work at elevation, the HSE Officer involved with the work must meet the work supervisor to review the scope of work, and must review all the possible fall hazards and effective safety responses. The evaluation / analysis must be documented and kept on file and on site by the HSE Officer.



**POWER
SECTOR**

**HEALTH, SAFETY AND ENVIRONMENT PLAN
FOR
SITE OPERATIONS
(SECTION-A)**

Doc. No.: HSEP:14-
ER

Rev.: 01

Date:08.05.20

Page 44 of 170

3. Whenever a fall hazard or other exposure exists for working at heights more than 2.0m/6ft, the nature and scope of work will be evaluated for conditions and environmental factors before selecting the appropriate fall protection system (active, passive or a combination of measures, as appropriate).
4. All Engineering and Administrative Controls including barricading, safe platform, Safety Nets etc. shall be made available at work location. Under no circumstances, there shall be total reliance on PPEs only
5. **Safety Nets**
 - a. Contractor shall maintain sufficient stock of Safety Nets for deployment
 - b. Safety Nets as per IS: 11057:1984 should be used extensively for prevention / arrest men and materials falling from height.
 - c. The safety nets shall be fire resistant, duly tested and shall be of ISI marked.
 - d. Safety Nets shall be deployed below all platforms where height work is envisaged. Duration of work, delay shall be no excuses for non-installation of Safety Net
6. Reaching beyond barricaded area without lifeline support, moving with support of bracings, walking on beams without support, jumping from one level to another, throwing objects and taking shortcut must be discouraged.
7. Monkey Ladder shall be fitted with cages. Rope ladder should be discouraged.
8. In case of pipe-rack, persons should not walk on pipes and walk on platforms only.
9. In case of roof work, walking ladder/ platform should be provided along with lifeline and/ or fall arrestor.
10. For chimney or structure painting, both hanging platform and men should be anchored separately to a firm structure along with separate fall arrestor.
11. The procedures for the safety response to identified fall hazards developed and rescue plans must be reviewed with all individuals exposed to the hazards.
12. The HSE Officer must establish an inspection process of fall protection systems. Some equipment requires documented inspections by its manufacture on a regular schedule. Such equipment must have evidence of the inspection and re-certification process on it. This information must be reviewed before the equipment is actually used. Individuals must visually inspect the fall protection equipment before each use. Failure to complete this inspection process could result in serious injury or death.
13. Immediately remove from service any fall protection equipment that is identified as defective, damaged, or has been subjected to an impact. Damaged fall protective equipment must be destroyed to prevent re-use and not be discarded into trash containers, as the worn or



**POWER
SECTOR**

**HEALTH, SAFETY AND ENVIRONMENT PLAN
FOR
SITE OPERATIONS
(SECTION-A)**

Doc. No.: HSEP:14-
ER

Rev.: 01

Date:08.05.20

Page 45 of 170

damaged equipment could be unintentionally re-used.

14. Aerial lifting devices, excluding scissor lifts require the use of full body harnesses and lanyards in any elevated position.

13.2.1.1 Personnel fall protection system must include:

a. Safety Harness

All height workers must use Safety harness with double lanyards. The primary lanyard is never unhooked until the secondary lanyard is secure. The design of the working platform should be such that **under no circumstances, worker should have both lanyards unhooked while at height.**

b. Lanyard

- i. The type of work and the environment conditions determine lanyard and lifeline selection. If welding, chemical cleaning that may damage lanyards, connectors or lifelines, sandblasting, etc., either protect the components or use more appropriate type of system.
- ii. Lanyards and lifelines must incorporate, or be used with, an appropriate deceleration (shock absorbing) device. Deceleration devices include rope grabs, rip-stitch lanyards, specially woven lanyards, tearing, or deforming lanyards, automatic self-retracting lifelines and lanyards which dissipate or limit the energy imposed on the employee during fall arrest.
- iii. Once in use, the system's effectiveness is to be monitored. In some cases, a program for cleaning and maintaining the system may be necessary. Lanyard and lifelines must use locking snap hooks only and under no circumstances must two lanyard snap hooks be connected.

c. Lifeline

All lifelines in general are to be made of min 8mm dia steel rope (plastic coated) and tied to columns with 3 clamps at each end. Wherever columns are not available to tie the lifelines, the vertical posts as per the design below are to be provided after carrying out drop load test initially. A load of 240kg to be dropped off the mid-point of lifeline in this test.

d. Lifeline Post



POWER
SECTOR

HEALTH, SAFETY AND ENVIRONMENT PLAN
FOR
SITE OPERATIONS
(SECTION-A)

Doc. No.: HSEP:14-
ER
Rev.: 01
Date:08.05.20
Page 46 of 170

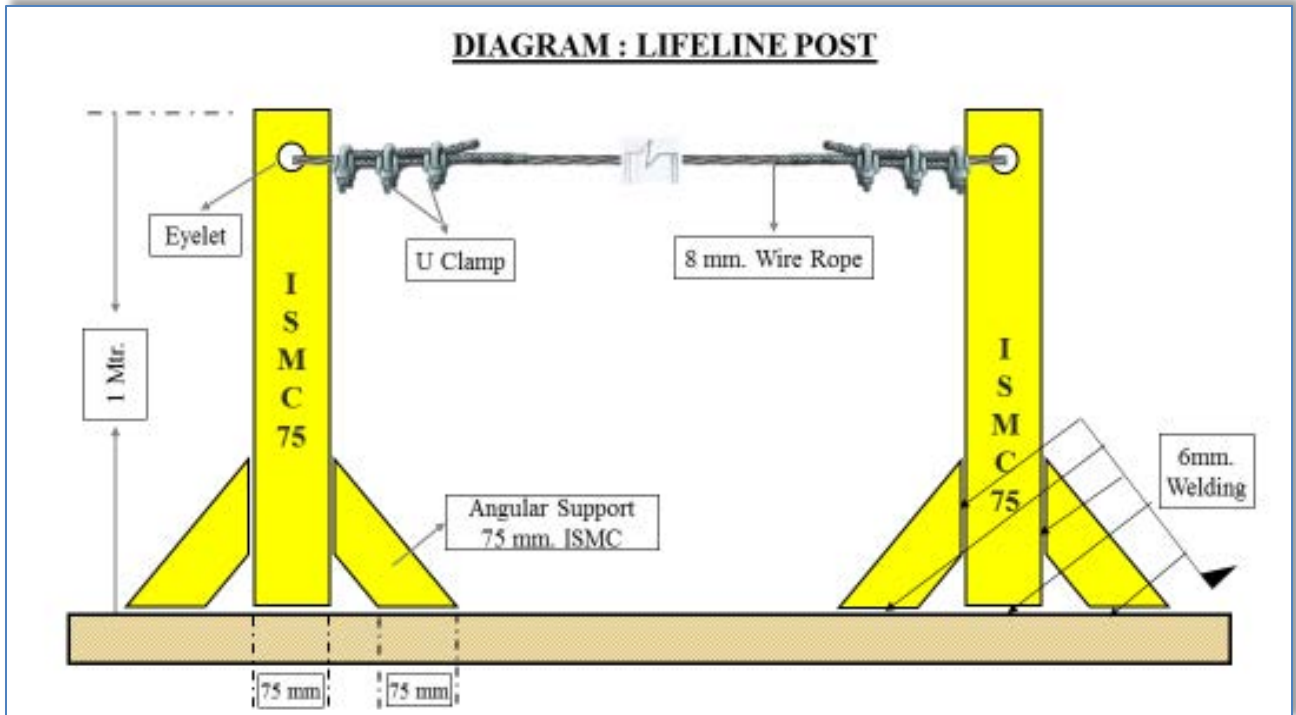

Fig. 13.2.1.1 Lifeline Post

- i. The support at vertical post shall be fixed at end-to-end. The maximum length of one end to another end shall be 18 meters
- ii. If the length of a lifeline is more than 18 meters, then intermediate vertical post(s) are to be used. Such intermediate post(s) will act as supports and the lifeline rope should simply pass through the eyelets (holes) of such supports without being anchored
- iii. The lifeline need not be wrapped / clamped to any intermediate post
- iv. Such intermediate posts must be used at an interval of every 18 meters
- v. The post(s) in which the original lifeline is to be installed should be capable of sustaining a tensile stress of 2268 Kgs
- vi. In a horizontal lifeline installation, maximum allowable sagging is 500-600 mm
- vii. For a single spun lifeline, no more than 2 persons are allowed to work; for more than two workers, another lifeline should be installed
- viii. Horizontal lifeline should be so installed that it does not impede safe movement of workers
- ix. All the installation work must be carried out by competent person with adequate knowledge

13.2.1.2 Working Platform

1. Working platforms, gangways and stairways shall be so constructed that they do not sag unduly or unequally and if the height of the platform gangways provided is more than 3.6 m above ground level or floor level, they shall be closely boarded and shall have adequate width, which shall not be less than 750 mm and be suitably fenced.

2. Precautions against the fall of Materials, Persons and Collapse of Structures



**POWER
SECTOR**

**HEALTH, SAFETY AND ENVIRONMENT PLAN
FOR
SITE OPERATIONS
(SECTION-A)**

Doc. No.: HSEP:14-
ER
Rev.: 01
Date:08.05.20
Page 47 of 170

- i. Every opening in the floor or a building or in a working platform shall be suitably barricaded to prevent the fall of persons by providing suitable fencing or railing whose minimum height shall be 90 cm.
- ii. Adequate precautions should be taken such as the provision of fencing, or barriers to protect any person who might be injured by the fall of materials, or tools or equipment being raised or lowered. Cradle may be used for lifting materials - however this shall be made of MS angles and flats only and duly certified by the HSE officer. Operators may also use designed containers for lifting small tools.
- iii. Guardrails (including scaffolding) erected over/adjacent working areas must have the guardrails screened (opening < 0.5), to prevent material from falling outside the platform/decking.
- iv. Guardrails must be able to withstand a 200-pound force exerted in any one direction.
- v. Where necessary to prevent danger, guys, stays or supports should be used or other effective precautions should be taken to prevent the collapse of structures or parts of structures that are being erected, maintained, repaired, dismantled or demolished.
- vi. All openings through which workers are liable to fall should be kept effectively covered or fenced and indicated in the most appropriate manner.
- vii. Guardrails and toe-board/barricades and sound platform conforming to IS: 4912-1978 and

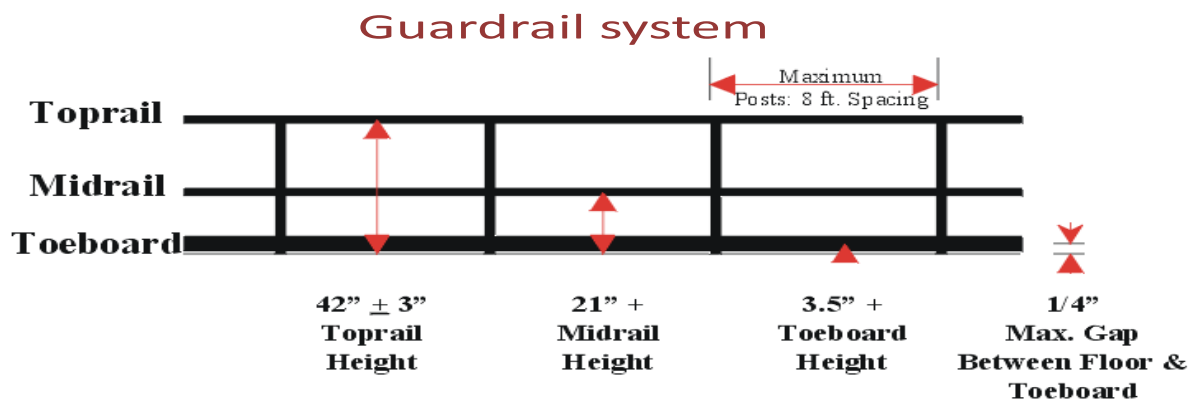



Fig. 13.2.1.2 Guard Rail System

11

- viii. Guardrails shall be provided to protect workers from falling from elevated work places. The rails are generally made of MS pipes of suitable dia. Rebar shall not be used for any handrails, ladder or cover purpose. Wherever the guard-rails and toe-boards cannot be provided:
 - a. adequate safety nets or safety sheets shall be erected and maintained; or
 - b. adequate safety harnesses shall be provided and used and / or
 - c. adequate fall arrestor shall be provided and used.

As mentioned under PPE clause, all these PPEs shall be defect free and regularly inspected for any defect. The full body safety harness shall have double lanyard only with max 1.8m length.

- ix. The monkey ladders shall have sufficient fall arrestors. Adequate lifelines of 8mm steel wire

 <p>POWER SECTOR</p>	HEALTH, SAFETY AND ENVIRONMENT PLAN FOR SITE OPERATIONS (SECTION-A)	Doc. No.: HSEP:14-ER
		Rev.: 01
		Date:08.05.20
		Page 48 of 170

rope shall be provided across the work area.

- x. The HSE officer shall recommend appropriate PPEs after analyzing hazards and risks involved.

13.2.1.3 Scaffolding

All scaffolds shall be conformant to the relevant standards including IS 3696 and IS 4014 as applicable. A sketch of the scaffolds proposed to be used shall be prepared and approval of the BHEL Engineer obtained prior to construction / use.

General

1. The scaffolding work must be carried out by a competent person, who shall train the scaffold users on safety aspects
2. All scaffolds shall be erected / dismantled by scaffolding crew under direct supervision of competent scaffolding supervisors.
3. All scaffolds shall be capable of supporting 4 times maximum intended load and erected on sound, rigid footing, capable of carrying the maximum intended load without settling or displacement. Bamboo scaffolding is not permitted for use on site.
4. Each employee on the scaffold shall use an approved safety harness attached to an independent lifeline. The lifeline is to be securely attached to substantial members of the structure (not the scaffold itself) or to securely rigged lines, which shall safely suspend a worker in event of a fall.
5. Guard rails and toe boards shall be installed on all open sides and ends of platforms more than (2) meters above ground or floor
6. Scaffold planks must be at least 5 cm x 25 cm (2" x 10") full thickness lumber scaffold grade or better.
7. Scaffold planks shall not span distances greater than 2.5 meters (8 feet).
8. Scaffold planks shall extend over end supports not less than 6 inches nor more than 12 inches and be secured to the scaffold. Scaffolding and accessories with defective parts shall be immediately repaired or replaced.
9. All scaffolding must be a minimum of two planks wide. No one may work from a single plank.
10. Scaffold planks must be inspected before use. Planks that have been damaged must be removed from the site.
11. Access ladders must be provided for each scaffold. Climbing the end frames is prohibited unless the design incorporates an approved ladder.
12. Adequate mudsills or other rigid footing capable of withstanding the maximum intended load must be provided.
13. Scaffolds more the 6 meters (20 feet) in height must be tied to the building or structure at intervals which do not exceed 4 meters (13 feet) vertically and 6 meters (20 feet) horizontally.
14. Do not overload scaffolds. Material should be brought up as needed. Scaffolding must not be loaded in excess of its rated capacity.
15. Barrels, boxes, kegs, blocks or similar unstable object must never be used as work platforms or to support scaffold.
16. Where persons must work under or pass under a scaffold then a 18 gauge wire mesh screen must be installed between the toe board and guard rail.
17. Employees exposed to overhead hazards while working on a scaffold will be protected by 5 cm (2") thick planks.
18. Wooden/bamboo ladders shall not be allowed at any cost. Ladder's rungs shall be fitted /welded properly. Before every use the rungs should be checked for safe use.



**POWER
SECTOR**

**HEALTH, SAFETY AND ENVIRONMENT PLAN
FOR
SITE OPERATIONS
(SECTION-A)**

Doc. No.: HSEP:14-
ER

Rev.: 01

Date:08.05.20

Page 49 of 170

19. Wooden scaffolds shall not be used in areas where fire / fire products are expected
20. Ropes made of jute / Plastic and other fire prone material shall not be used to tie up scaffolding components together
21. The platform should have permanent hand rail and mid rail with Toe board without fail.
22. All platforms are to be tightly planked for the full width of the scaffold, except as may be necessary for entrance openings. Platforms shall be secured in place.
23. On suspension scaffolds designed for a working load of 500 pounds, no more than two workers are permitted to work on the scaffold simultaneously. On suspension scaffolds with a working load of 750 pounds, no more than three workers are permitted on the scaffold simultaneously.

24. Requirements for different types of Scaffolds:

A. Suspended Scaffold

- i. Suspended scaffolds are platforms suspended by ropes, or other non-rigid means, from an overhead structure.
- ii. Requirements for use are to be preapproved by HSE Head, under a specific Permit to Work.

B. Rolling Scaffolds

- i. The height of rolling scaffolds shall not exceed three times the minimum base dimension.
- ii. The minimum base dimension of rolling scaffold will be 1.25 meters (4 feet).
- iii. Adequate help must be provided when moving a rolling scaffold.
- iv. Secure or remove all loose materials, equipment and tools before moving a rolling scaffold.
- v. No one is permitted to ride a rolling scaffold when it is being moved. Castor brakes must be locked-on when the scaffold is not being moved.

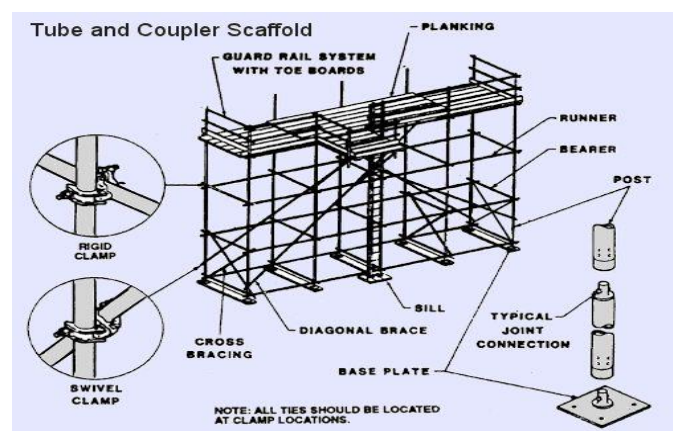
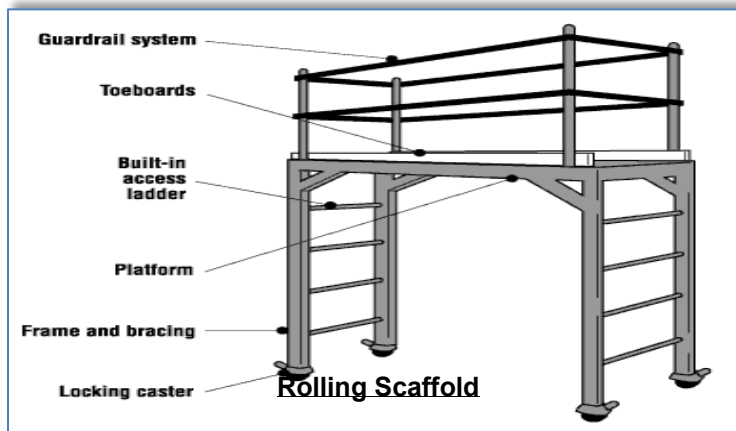



Fig. 13.2.1.3 Types of Scaffolds

25. Scaffold Tagging

Scaffolds being erected, modified or dismantled must be tagged as suitable for use. The scaffolds can only be accessed by those involved with the process.

GREEN scaffold tag- shall be fixed when scaffold is complete and safe for use, signed and dated by

 POWER SECTOR	HEALTH, SAFETY AND ENVIRONMENT PLAN FOR SITE OPERATIONS (SECTION-A)	Doc. No.: HSEP:14-ER
		Rev.: 01
		Date:08.05.20
		Page 50 of 170

the scaffolding competent person daily.

RED scaffold tag – to be fixed if scaffold is in some way defective and cannot be used or is still under erection.

Examples of scaffold tags:



Fig. 13.2.1.4 Scaffold Tagging

13.2.1.4 Ladder Safety

A sketch of the ladders proposed to be used shall be prepared and approval of the BHEL Engineer obtained prior to construction / use

Safe Use of Ladders:

1. Fall protection is required when working on a ladder above 2 meters and when climbing above nearby guardrails.
2. Ladders must be inspected prior to use and by a competent person quarterly, with documentation.
3. Use portable ladders for height up to 4 M only
4. Provide fixed ladders for height above 4 M
5. Place the ladder at an angle of 75 degrees (approx.) from the horizontal (1:4)
6. Extend ladder at least 1 M above the top landing
7. Secure top and bottom of the ladder firmly to prevent displacement- anti skid lining at the bottom
8. Ensure that the width of the ladder is not less than 300 mm and distance between rungs is not more than 300 mm
9. Provide landings of minimum size 600 x 600 mm at intervals not more than 6 M for fixed ladders. Check the ladders daily for any defects
10. Ensure that the areas around base and top of the ladder are clear. Getting on and off the ladder is more hazardous than using it. Use a mudsill if the ladder is to rest on soft, loose or rough soil
11. Do not use ladders of conducting material near power lines, and only use ladders near power line or other energize system with exposed parts if they are confirmed locked-out and de-



**POWER
SECTOR**

**HEALTH, SAFETY AND ENVIRONMENT PLAN
FOR
SITE OPERATIONS
(SECTION-A)**

Doc. No.: HSEP:14-
ER

Rev.: 01

Date:08.05.20

Page 51 of 170

energized.

12. Stand no higher than the fourth rung from the top for carrying out any job standing on a ladder.
13. Never reach out from a ladder to perform work where your belt buckle protrudes past the ladder rung.
14. Always face the ladder while climbing up or down
15. Maintain three-point contact while climbing up or down a ladder i.e. two hands and one foot or two feet and one hand on the ladder at all the times.
16. Avoid climbing up or down a ladder while carrying anything in hands. Lift tools, equipment and materials with a rope.
17. Work from portable and extension ladders near guardrail where fall expose exists over the guardrail regardless of height, and above 2.0 mtr. heights from the working/walking surface will require the use of personal fall arrest equipment

13.2.2 EXCAVATION & CIVIL WORKS

All safety precautions shall be taken for foundation and other excavation marks as per IS-3764.

13.2.2.1 Excavation

The following safety measures are to be ensured before and during excavation:

1. All Excavation activities more than with depth of 1.22 meter or more shall require and Excavation Work Permit
2. Check for underground utilities like electrical / telephone cables, sewage, water lines and proper care has to be exercised to protect and prevent damage to it
3. Proper and adequate slope is maintained while excavating
4. Adequate shoring or sheeting is done wherever require to prevent soil sliding
5. Safe access through ladder or steps for exit & entry to excavation
6. No material /excavated soil is kept within one meter from the edge
7. Safe way is planned and provided for movement of HEM /transport equipment near excavation
8. Safety helmet and shoes/gum boots are provided and worn by the workmen at excavation works
9. Dewatering arrangement is made where water seepage is prevailed.
10. Stop blocks are provided to avoid vehicles reversing into the excavated trenches
11. Danger signs /Caution boards are displayed at work spot
12. Barricading is provided at excavated pits



POWER
SECTOR

HEALTH, SAFETY AND ENVIRONMENT PLAN
FOR
SITE OPERATIONS
(SECTION-A)

Doc. No.: HSEP:14-
ER

Rev.: 01

Date:08.05.20

Page 52 of 170

Soil Type	Height/Depth ratio	Slope Angle
Stable Rock	Vertical	90 deg.
Type A	¾ : 1	53 deg.
Type B	1 : 1	45 deg.
Type C	1½ : 1	34 deg.

Determining Soil Type		
Type	Description	Examples
A	Cohesive soils with an unconfined compressive strength of 1.5 tons per square foot or greater.	Clay, silty clay, sandy clay, clay loam and in some cases: silty clay loam and sandy clay loam.
B	Cohesive soils with unconfined compressive strength greater than 0.5 tsf but less than 1.5 tsf.	Angular gravel (similar to crushed rock), silt, silt loam, sandy loam and, in some cases silty clay loam and sandy clay loam.
C	Cohesive soils with unconfined compressive strength greater than 0.5 tsf or less.	Granular soils such as gravel, sand and loamy sand; submerged soil or soil from which water is freely seeping; submerged rock that is not stable.

Fig. 13.2.2.1 Excavation Reference

13.2.2.2 Piling

Ensure the following precautionary measures before starting piling works:

1. Inspection of piling equipment by responsible person for its condition before initiating piling operation.
2. Checklist and OCP for piling to be prepared using manufacturer's instructions and used
3. Testing and its certification wire ropes, slings, D-shackles, chain pulley blocks using in the process of piling work by competent person
4. Adequate support and secured foundation of the piling equipment to avoid toppling
5. Hoses should be lashed and adequately secured
6. Proper work platform is to be provided on piling frame
7. Safe work procedures and close supervision to prevent unsafe acts of operators/any unsafe conditions that may arise
8. Only experienced and trained operators are engaged for the piling operation
9. Provision of Personal Protective Equipment (PPE) like safety shoes/gumshoes/safety helmet/safety belt etc. and its use by their workmen.
10. Special care and precautions If work is near electrical live cables/ electrical equipment
11. Cordoning of work area to prevent un authorized entry
12. Guarding of revolving parts
13. Specific measures to prevent over turning of pile driver/missing of hammer/ hammer movement out of range

13.2.2.3 Batching

Following Safety considerations for batching plant are to be ensured:

1. Modern type batching plant should be used in which all the moving parts are protected and



**POWER
SECTOR**

**HEALTH, SAFETY AND ENVIRONMENT PLAN
FOR
SITE OPERATIONS
(SECTION-A)**

Doc. No.: HSEP:14-
ER

Rev.: 01

Date:08.05.20

Page 53 of 170

emergency and safety features are incorporated.

2. Installation of external Electric moto-vibrators in the feeding hopper of all batching plants to reduce human intervention.
3. Installation of safety devices like pull-chord on both the sides of conveyor for stopping the conveyor in emergency
4. Workers carrying cement / sand to be given appropriate PPEs like respiratory masks & gloves.
5. Conveyor belt/rotating parts must be guarded properly.
6. Safety awareness shall be inculcated in workmen about the risk involved in rotating parts.
7. The agency shall ensure to erect the batching plant as per drawing including installation of all safety devices as provided by manufacturer and witnessed by BHEL Engineer in charge before starting of machine in future.
8. Safety audit to also focus on Batching plant.
9. The site shall impose penalty on the agency who has violated the safety norms as per contract.

13.2.2.4 Mobile Plant

Mobile plant includes tractors, trailers, dumpers, excavators, bulldozers, road rollers etc. for earthmoving purpose and concrete mixers, concrete transit mixtures, concrete pumps etc for concreting purpose. Due to the very nature of their function and movement in difficult terrains, congested areas, working in tandem with manual work and other operations the danger is inherent. Reverse horn is compulsory for all earth moving machineries.

Following Safety measures to be ensured for Mobile Plant:

1. Where movement around site is involved, routes should be planned, obstruction free and well maintained
2. Observe specified speed limits
3. Operating personnel should be aware of associated risks and its preventive measures
4. Only experienced, trained and authorized persons with valid license (wherever applicable) should operate the mobile equipment/vehicles
5. Provide and use Warning lights and reverse horn for cautioning the people around
6. Operation should be on level and stable ground with adequate working clearance.
7. Loading of out riggers/stabilizers should be well within safe ground bearing capacity
8. No person should be on equipment or vehicle during loading and unloading of material
9. Operators should be protected by warning barriers or switching off power when working in close proximity of overhead power lines
10. The equipment /vehicles should be well maintained and provided with effective brake system and other safety devices (wherever require)
11. Rotating parts of equipment should be adequately guarded
12. Provide necessary personal protective appliances and ensure its use by the operating personnel Ensure effective measures at source to control harmful emissions, dust, fumes contaminating atmosphere and cause health hazards to the operators and people in the vicinity.
13. No overloading/over stressing of vehicles/plant is allowed
14. Hoses, pipes, receivers, gauges and valves involved in carrying out hydraulic fluid/ compressed air should be checked for leaks and tested prior to operation.
15. Adequate safe clearance for swing and movement is to be judged during operation of Concrete mixer



**POWER
SECTOR**

**HEALTH, SAFETY AND ENVIRONMENT PLAN
FOR
SITE OPERATIONS
(SECTION-A)**

Doc. No.: HSEP:14-
ER

Rev.: 01

Date:08.05.20

Page 54 of 170

16. Setting of machine on firm and level ground with wheel locked to prevent movement of machine
17. Proper instructions and Special precautions are to be ensured to prevent entry in to the danger zone of projectile of bucket while dropping bucket
18. Operator leaving work spot should ensure that the equipment/vehicle is kept in neutral position and place on firm and level ground.
19. The hand brake should be kept in position and block road wheels as additional safety measure
20. Blades/buckets should be kept low while moving
21. The dozer blades should not be used as brakes except in emergency
22. The ground should be examined for its bearing capacity and general safety especially when operating road roller at the edges of slopes, embankments.
23. The roller should not be moved downhill with the engine out of gear
24. If operating near excavations the following precautionary measures are to be ensured
25. Barricading, edge protection to prevent fall of persons/vehicles over running while reversing etc.
26. Suitable support system and adequate allowance to avoid the danger of side collapsing
27. Experienced signaller /attendant should be always accompanied with operator/driver for proper direction /signal and also to caution others in the working Zone during operation of mobile plant

13.2.2.5 Concrete Vibrators

1. Revolving parts/belt drives should be adequately guarded and Vibrating unit shall be completely enclosed and have suitable overload relays and effectively earthed
2. Ensure sufficient length of cable to the Vibrator.
3. Ensure electric starters and other accessories are firmly fixed adequately supported
4. Ensure locking of needle load while inserting needle in to the vibrator,
5. Ensure periodical lubrication and maintenance

13.2.2.6 Concrete Mixers

1. Setting of machine on firm and level ground with wheel locked to prevent movement of machine
2. Proper instructions and Special precautions are to be ensured to prevent entry in to the danger zone of projectile of bucket while dropping bucket

13.2.3 WELDING & GAS CUTTING SAFETY (HOT WORK)

1. All Hot Work shall require a Hot Work Permit
2. There shall be flash-back arrestors conforming to IS-11006 at both cylinder and burner ends. Damaged tube and regulators must be immediately replaced.
3. All safety precautions shall be taken for welding and cutting operations as per IS-818.
4. When possible, items to be welded, cut, heated, etc. shall be moved to a safe location free of combustible or flammable material. If this is not possible, then all combustibles/ flammables that can be removed from the area shall be removed within a 35-foot circumference and a positive means of confining arcs and sparks generated by the process shall be ensured and additional person(s) shall be stationed as fire-watch for the area(s) still exposed, along with obtaining the Hot Work Permit as applicable.
5. Appropriate fire-fighting equipment is to be available in close proximity of any welding and gas cutting operations at all times suitable for the type of Fire.
6. Drums, tanks, and similar containers that have contained flammable or toxic material shall not be welded, cut, or heated until they have been made safe by water filling, thorough cleansing or similar accepted practices. The container shall also be ventilated during the welding, cutting, or heating process.



**POWER
SECTOR**

**HEALTH, SAFETY AND ENVIRONMENT PLAN
FOR
SITE OPERATIONS
(SECTION-A)**

Doc. No.: HSEP:14-
ER

Rev.: 01

Date:08.05.20

Page 55 of 170

7. Proper ventilation is required for any welding or torch operations performed in a confined space.
8. Any welding or gas cutting operations performed on metals of toxic compounds or coating such as zinc, stainless steel, lead, cadmium, chromium, and beryllium shall be properly ventilated and/or proper respiratory protection shall be worn by any person that could be exposed to fumes, vapors, and gasses created by the welding and gas cutting processes.
9. Wherever it is practical, all arc welding operations shall be shielded to prevent direct light rays or sparks from contacting persons in the vicinity or from reaching areas normally used to travel through or into the vicinity. Where this is not practical, persons who shall be in the area are to use proper eye and skin protection. Other persons who are not participating in the welding or gas cutting operations are not to be allowed into the hazard zone.
10. Welders and other employees who are exposed to arc welding radiation shall wear suitable clothing and protective apparel to prevent burns and other types of ultraviolet radiation damage to the skin.
11. Arc welding machines shall be shut down when being moved or when they are not in continuous use. Electrode holders left unattended shall have electrodes removed and shall not be left where they might contact employees or conducting objects.
12. Arc welding power supply cable shall be of proper rating and material, e.g. copper.
13. Welders shall guard against allowing materials adjacent to or behind them to reflect radiation back toward them or towards others in the area. Reflected radiation can cause skin burns and eye flash burns.
14. Valve caps shall be in place when cylinders are not in use. Valve caps shall never be used for lifting the cylinder vertically.
15. Torches shall only be lit by approved strikers; never with matches, cigarette lighters, or hot-work.
16. **Splatter / Slag Collector**

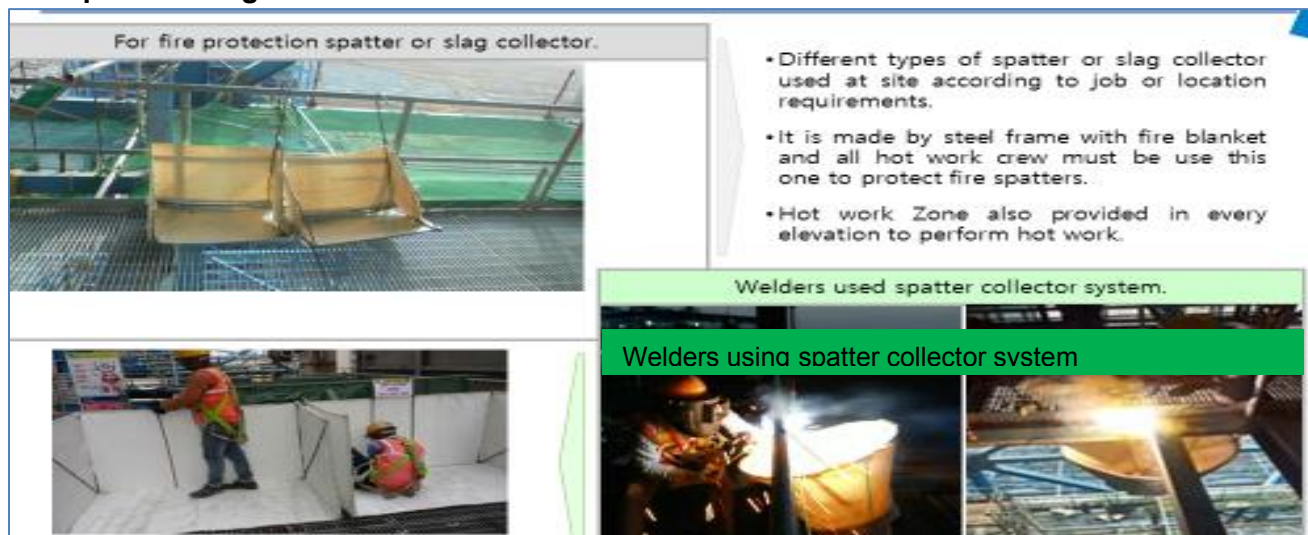

Fig. 13.2.3.1 Splatter / Slag Collector

While carrying out job at height, the sparks or molten slag shall be prevented from falling down by putting a fire-resistant (non-asbestos) sheet or pattrer/ slag collector or even MS Sheet. The passage of falling sparks or molten slag shall be barricaded till ground floor and any cable/ tubes/ any other objects interfering in the passages hall either be removed or covered with Fire-resistant sheet or MS Sheet.



**POWER
SECTOR**

**HEALTH, SAFETY AND ENVIRONMENT PLAN
FOR
SITE OPERATIONS
(SECTION-A)**

Doc. No.: HSEP:14-
ER

Rev.: 01

Date:08.05.20

Page 56 of 170

13.2.3.1 COMPRESSED GAS

1. All cylinder valves shall be closed when any work is finished and when any Cylinders are empty or being moved. Valve protection caps shall be placed and secured properly before gas cylinders are transported, moved or stored.
1. Compressed gas cylinders shall be secured in an upright position with chain or appropriate means during storage & use. However, a trolley shall be used for transportation.
2. Compressed gas cylinders shall always be secured from tipping or falling, whether in use, in storage or in transit. The cylinders shall always be secured upright, except during times when actually being hoisted or carried.
3. When cylinders are transported by powered vehicle they shall be secured in a vertical position.
4. Regulators shall be removed when cylinders are not in use or are in transit, unless the cylinder is firmly secured on a special carrier designed for this purpose.
5. Gas cylinders are not allowed to be used in man-basket when occupied.
6. Cylinders containing oxygen or fuel gasses shall not be taken into confined spaces.
7. Oxygen cylinders shall be stored a minimum of 6 meters from fuel gas cylinders or shall have an approved firewall between them.
2. All cylinders shall be kept at a safe distance from welding or cutting operations or shielded from arc/ sparks / slag.
3. All cylinders shall be placed where they cannot become part of the electrical circuit.
4. Oxygen and acetylene shall not be stored together. Oxygen must be separated from acetylene (or ANY fuel gas) or combustible material by at least 20ft or a barrier with a 30 minute fire resistance rating.
5. All Cylinders should be stored upright in a designated area with labels for the type of gas. All applicable precautions to be ensured during storage
6. Oxygen and fuel gas regulators, hoses and associated equipment shall not be altered and shall be in proper working order while in use.
7. Compressed air can be extremely dangerous if allowed to penetrate the skin. As such, the use of compressed air to clean off yourself or other workers shall be strictly prohibited.
8. All gas cylinders shall be stored in upright position. Suitable trolley shall be used for cylinder movement, the design of which shall be submitted to BHEL Engineer for approval.
9. No of cylinders shall not exceed the specified quantity as per OCP
10. Cylinders shall be moved by tilting and rolling them on their bottom edges. They shall not be intentionally dragged, struck or permitted to strike each other violently.
11. All cylinder should be kept only in cylinder trolley.
12. Cylinder shall be transported in upright vertical position by suitable mean.

13.2.4 LIFTING & RIGGING SAFETY

1. All Heavy / Complex Lifting operations as defined in Clause 6.12 shall require a Lifting Work Permit.
2. All the cranes and lifting tools & tackles shall be inspected on daily / weekly basis as well as



**POWER
SECTOR**

**HEALTH, SAFETY AND ENVIRONMENT PLAN
FOR
SITE OPERATIONS
(SECTION-A)**

Doc. No.: HSEP:14-
ER

Rev.: 01

Date:08.05.20

Page 57 of 170

monthly by expert as per applicable formats.

3. In addition, inspection / certification as mandated by law shall be carried out wherein these shall be tested and certificates of fitness shall be obtained from 3rd party State Govt. approved competent agency before deploying at site and later periodically. BHEL shall be given advance intimation of any such inspections
4. The last date of Third Party Inspection and the next Due date shall be conspicuously displayed on all cranes. A copy of certificate shall be pasted on operator's cabin of all the lifting equipment.
5. Following requirements shall be mandatorily followed, wherever applicable:
 - a. The manufacturer's instruction for maintenance shall also be followed. All safety measures shall be followed.
 - b. All tools tackles, lifting appliances; material-handling equipment etc. used by the subcontractor shall be of safe design and construction.
 - c. The operators, slingers and signalers shall be qualified as per IS 13367 (part-1):2003 "Safe use of cranes- code of practices".
 - d. There shall be a person responsible for co-ordination among cranes where multiple cranes are used, and lifting over 75% of the crane capacity to be avoided.
 - e. Mobile phone should be banned for crane operator and lifting operation. Only walki talki shall be allowed in rigging/Lifting purpose.

13.2.4.1 Personnel Lifts (Man-Basket / Jhoola):

The design of personnel man basket shall be submitted to BHEL Engineer for approval before use. Relevant permit (Height work & others as applicable) shall be completed prior to lifting any people, along with a rigging plan.

- a. A separate Lifeline / Fall arrestor anchored to a fixed structure outside of Jhoola shall be provided for the workers inside the basket. All occupants of the basket shall have Safety Harnesses equipped with rope grabs, which are to be hooked to the vertical lifeline.
- b. Man-basket shall be used where access through ladders or scaffolding is not feasible.
- c. Man-baskets shall be designed and engineered by a manufacturer (job made man-baskets are not allowed, unless designed and tested by a certified engineer), and built robust with MS Angles and flats or plates or channels only.
- d. Guard rails top and mid, must be in place and screened-in to avoid material from falling out of basket. The factor of safety shall be 200%.
 - e. It shall have a door with double latches and shall open inside. Anchor points shall be identified within the man-basket.
- f. The man-basket shall be thoroughly inspected and load tested and a trial run performed without personnel before being put to job.
- g. It shall be treated as a lifting tool (T&P Item) and shall undergo same certification cycle and inspection as other lifting equipment.
- h. An additional sling of required lifting capacity shall be fixed the man-basket main lifting point and attached to the crane above the ball or block.



POWER
SECTOR

HEALTH, SAFETY AND ENVIRONMENT PLAN
FOR
SITE OPERATIONS
(SECTION-A)

Doc. No.: HSEP:14-
ER
Rev.: 01
Date:08.05.20
Page 58 of 170

- i. While lifting man-basket, the crane shall maintain a uniform speed of lift without any swing.
- j. Once man-basket reaches the destination, the lift brakes shall be locked as long as the basket remains at that point. The same care shall be taken in its descent.
- k. As for hanging man-basket, the same shall be hung off a rigid structure with help U-shaped handle welded to man-basket. This shall be tested once in a year by a competent person.
- l. Use of Rebar steel for making and monkey-ladder must be avoided.

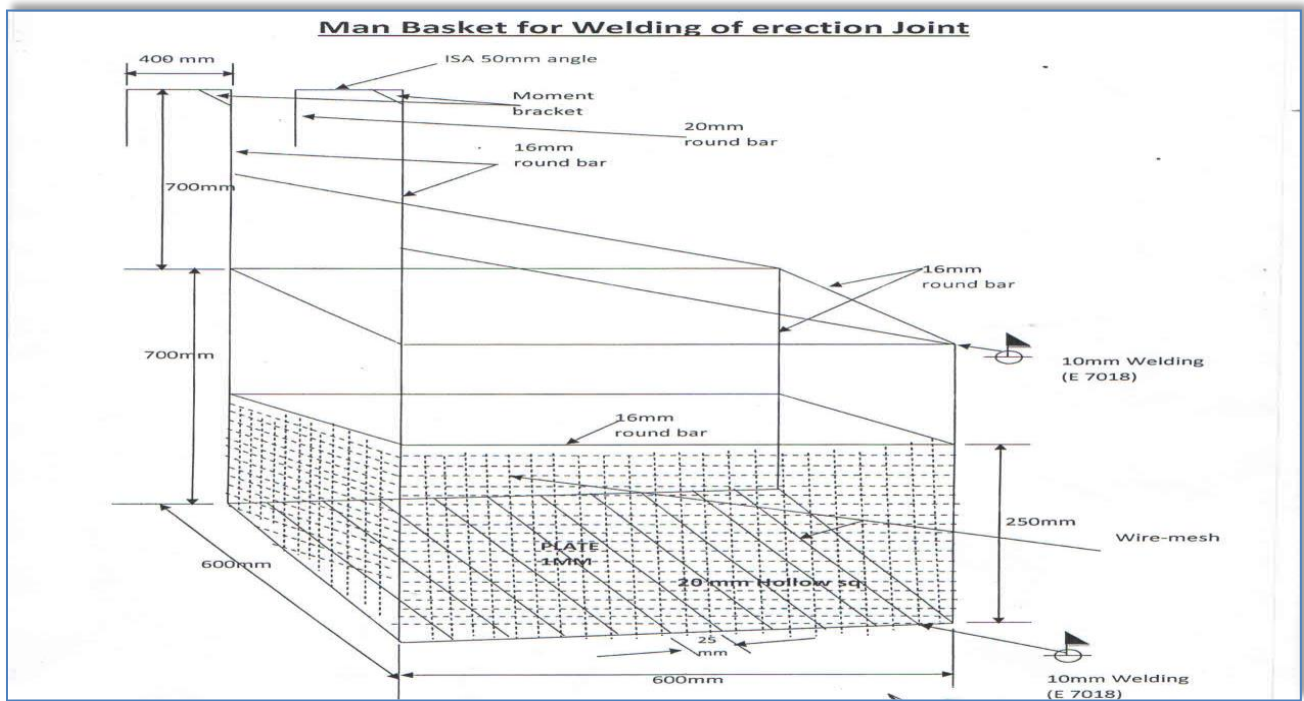

Fig. 13.2.4.1 Man Basket for Welding Erection Joint

13.2.4.2 Cranes & Hoisting Equipment:

This section provides the guidelines to ensure proper rigging and lifting activities are accomplished safely and in accordance with applicable specifications, codes, and regulations.



**POWER
SECTOR**

**HEALTH, SAFETY AND ENVIRONMENT PLAN
FOR
SITE OPERATIONS
(SECTION-A)**

Doc. No.: HSEP:14-
ER
Rev.: 01
Date:08.05.20
Page 59 of 170

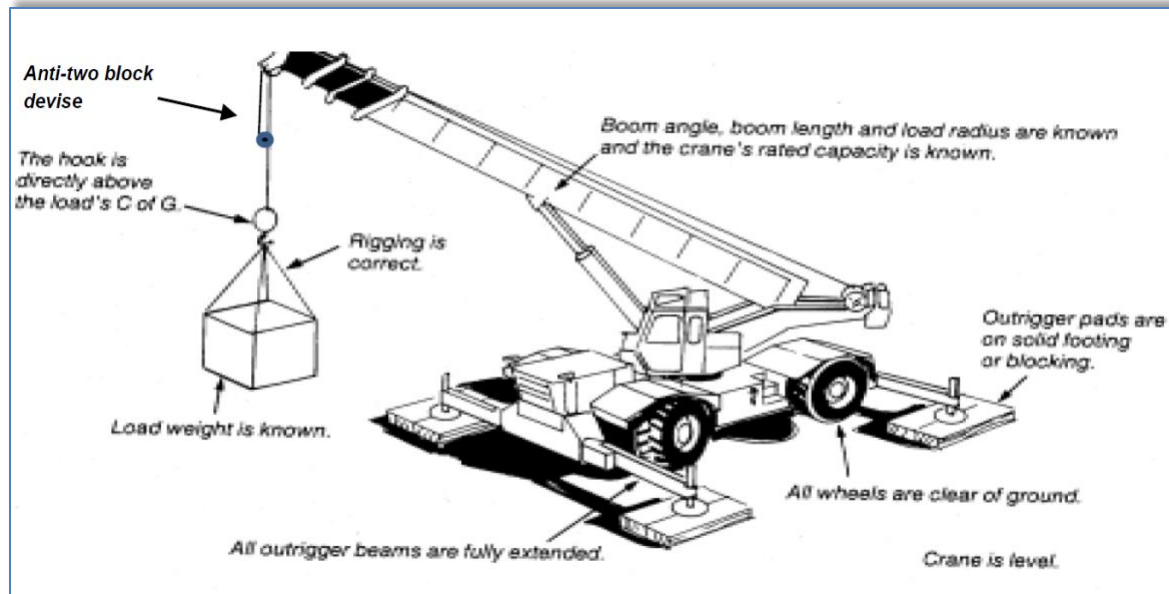

Fig. 13.2.4.2 Proper Crane Setup

- a. On every crane or piece of hoisting equipment notices of all rated load capacities, recommended operating speeds, and any hazard warnings or special instructions shall be conspicuously posted. All instructions and warning shall be visible from the equipment operator 's station.
- b. Cranes shall have an Anti-Two-block safety device installed
- c. All mobile cranes shall have overload and backup alarms, load angle indicators and limit switches
- d. All areas within swing radius of cranes that are potentially accessible by pedestrian, vehicular, or equipment movement shall be barricaded to prevent anyone or any vehicle or equipment from being struck by the crane or hoisting equipment, or its load(s).
- e. No part of the lifting equipment or its load shall be within the distance as specified in the Indian Electricity Act from an energized power line
- f. Cranes shall have annual certified third party inspection and be inspected before use by the operator. Any defects shall be corrected before use. Logs of crane inspection shall be kept with the crane.
- g. Make certain that the rigging personnel, material, and equipment have the necessary capabilities for the job and are in safe condition.
- h. Communicate with person(s) directly responsible for accomplishing the work and / or work area to establish requirements/responsibilities and make certain that all preparatory work is complete.
- i. Mats/Pads must be used on all lifting equipment, equipped with out riggers.
- j. Pick and carry must have the load secured to the rig in front.
- k. Only BHEL Approved Plate Lifting Spreader Beam configuration shall be used (Sample in Fig. 13.2.4.2)



POWER
SECTOR

HEALTH, SAFETY AND ENVIRONMENT PLAN
FOR
SITE OPERATIONS
(SECTION-A)

Doc. No.: HSEP:14-
ER
Rev.: 01
Date:08.05.20
Page 60 of 170

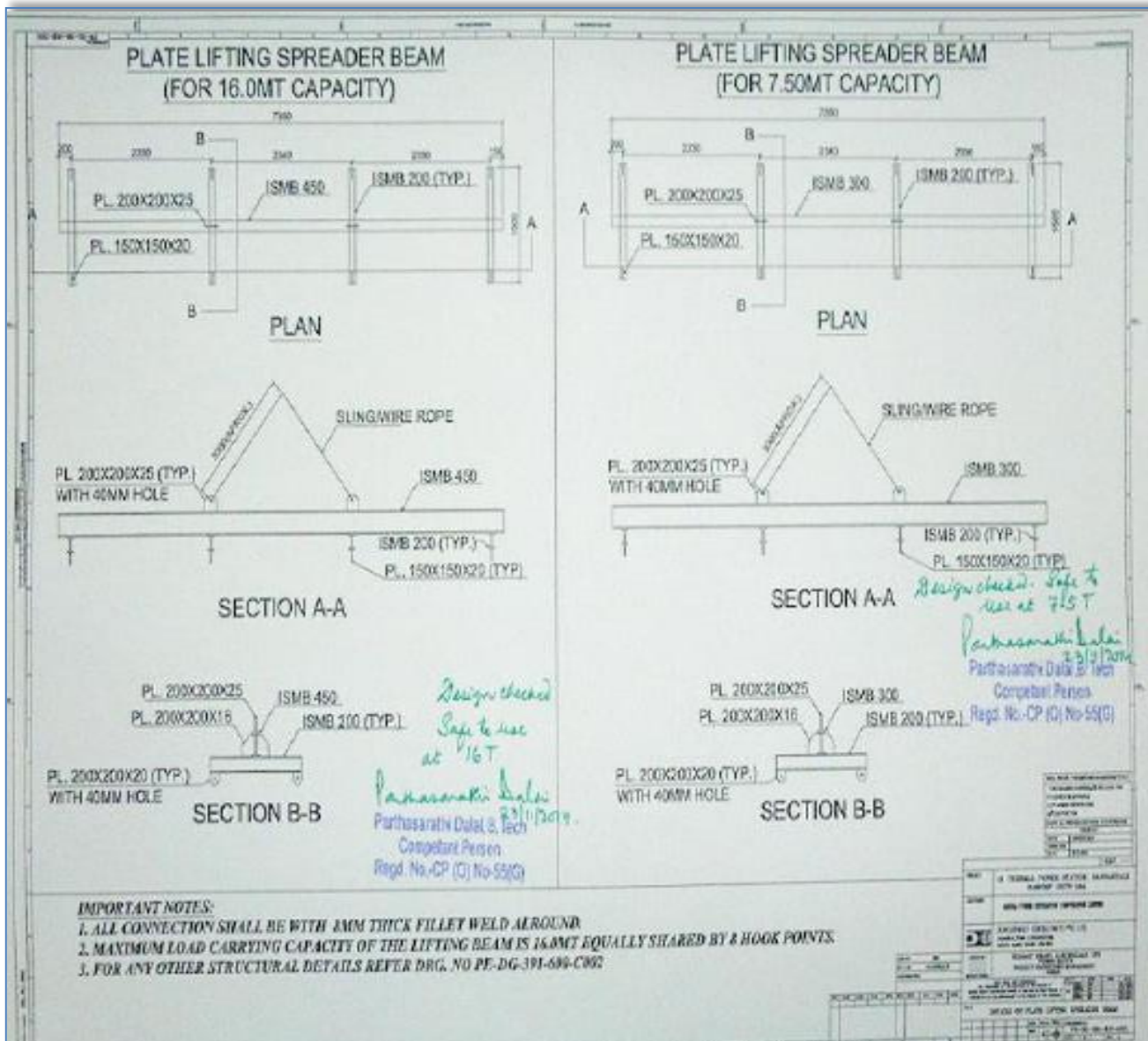

Fig. 13.2.4.3 Typical Plate Lifting Spreader Beam Configuration for 7.5 MT and 15 MT Loads

I. Crane operators must follow the following:

1. Pass an annual Operator's Physical examination
2. Carry a valid training certification card at all time while operating issued by the Govt. or other recognized institute.



**POWER
SECTOR**

**HEALTH, SAFETY AND ENVIRONMENT PLAN
FOR
SITE OPERATIONS
(SECTION-A)**

Doc. No.: HSEP:14-
ER

Rev.: 01

Date:08.05.20

Page 61 of 170

13.2.4.3 SAFE RIGGING PRACTICES

13.2.4.4

- a. Review the planned operation and requirements with the operator and rigging crew.
- b. Ensure a pre-lift meeting is conducted with crane operator, tagline operator, signal personnel, and Safety Manager.
- c. Designate a qualified person from the rigging crew to observe clearance of the equipment and give timely warning for all operations where it is difficult for the operator to maintain the desired clearance by visual means.
- d. Clear the lift area of all unnecessary personnel.
- e. Hydras shall only be allowed for loading & unloading works & shall not be allowed to move with load

13.2.4.4.1 RULES FOR SAFE RIGGING

1. Use loops, thimbles and corner pads to prevent damage to slings when used around corners or on cutting edges.
2. Never allow wire rope to lie on the ground for any length of time or on rusty steel or near solvents, chemicals or corrosive substances.
3. Slings must not be pulled from between or under loads with load resting on the sling.
4. Keep all rope away from flame cutting or welding operations.
5. Never use rope as sling material.
6. Never wrap a wire rope completely around a hook.
7. Do not bend wire rope near any attached fitting.
8. The sling must be selected to suit the most heavily loaded leg rather than the total weight when using multi-legged sling to lift loads in which one end is heavier than the other.
9. When using 3 and 4 legged sling configurations, any two legs must be capable of supporting the entire load.
10. Where possible, wire rope choker hitches must include a shackle with the eye around the shackle pin to prevent breaking wires of the choke. The choker hitch must be "snugged down" prior to lifting, not after tension is applied.
11. Unless authorized by the hook manufacturer when more than two rope eyes are placed over a hook, install a shackle, pin resting in the hook, and place the rope eyes in the bowl of the shackle.
12. Properly rig all loads to prevent dislodgment of any part.
13. Use guide ropes or tag lines to prevent the rotation or uncontrolled motion of the load when necessary.
14. Loads must be safely landed and properly blocked before being unhooked and unslung. Tag lines must not be used in situations that jeopardize the safety of the lift.
15. Lifting beams must be plainly marked with their weight and designed working load and must only be used in the manner for which they were designed.



**POWER
SECTOR**

**HEALTH, SAFETY AND ENVIRONMENT PLAN
FOR
SITE OPERATIONS
(SECTION-A)**

Doc. No.: HSEP:14-ER
Rev.: 01
Date:08.05.20
Page 62 of 170

16. The hoist rope or chain must never be wrapped around the load. The load must be attached to the hook by slings or other rigging devices that are adequate for the load being lifted.
17. Multiple part lines must not be twisted around each other.
18. The hook must be brought over the center of gravity of load before the lift is started.
19. If there has been a slack rope condition, determine that the rope is properly seated on the drum and in the sheaves prior to lifting.
20. Keep hands away from pinch points as the slack is being taken up.
21. Leather gloves are recommended when handling wire rope.
22. Avoid impact loading caused by sudden jerking when lifting or lowering. Lift the load gradually until the slack is eliminated.
23. Never ride on a load that is suspended.
24. Avoid allowing the load to be carried over the heads of any personnel.
25. Never work under a suspended load until the load has been adequately supported from the floor and all conditions have been approved by the supervisor in charge of the operation.
26. Never leave a load suspended unless emergency evacuation is required.
27. Never make temporary repairs to sling.
28. The capacity of a sling is determined by its angle, construction, type of hitch and size.
29. Never lift loads with one leg of a multi-leg sling until the unused legs are made secure.
30. Never point load a hook unless it is especially designed and rated for such use.
31. Make certain that the load is broken free before lifting and that all legs are taking the load.
32. When using two or more slings on a load make certain all slings are made from the same materials.
33. Lower the loads on to adequate blocking to prevent damage to the slings.
34. Materials and equipment being hoisted must be loaded and secured to prevent any movement which could create a hazard in transit.
35. The weight of the hook, load block and any material handling devices must be included when determining crane capacity.
36. Calculated weights cannot exceed 75% of the chart without written approval.
37. Personnel must be completely clear of loads being picked up or set down by crane. Tag lines will be used to control the loads. Loads must not be touched by hand while placing/ moving.

13.2.4.4.2 SLINGS

a. Synthetic Slings

The following are rules for safe use of synthetic slings:

- i. Synthetic slings must be marked to show the rated capacity for each type of hitch and type of web material.
- ii. Nylon web slings must not be used where fumes, vapors, sprays or mists or liquids of acids or phenolic are present. Web slings with aluminum fittings must apply in this category.
- iii. **Synthetic web slings must be removed from service and destroyed if any of the following conditions are present:**



**POWER
SECTOR**

**HEALTH, SAFETY AND ENVIRONMENT PLAN
FOR
SITE OPERATIONS
(SECTION-A)**

Doc. No.: HSEP:14-ER
Rev.: 01
Date:08.05.20
Page 63 of 170

- a. Acid or caustic burns
- b. Melting or charring of any part of the sling surface
- c. Snags, punctures, tears or cuts
- d. Broken stitches
- e. Distortion of fittings
- f. Synthetic web slings of polyester or nylon must not be used at or come in contact with temperatures in excess of 82°C
- g. Polypropylene web slings must not be used at or come in contact with temperatures in excess of 93°C
- h. Insulated hooks must be tested yearly to insure insulation integrity to at least manufacturer's specifications.

iv. Wire Rope Slings must be removed from service and destroyed if any of the following conditions are present:

- a. In (10) randomly distributed wires broken in one (1) rope lay, or five (5) broken wires in one (1) strand in one (1) rope lay.
- b. Wear or scraping of one-third the original diameter of outside wires.
- c. Kinking, crushing, bird caging or any other damage resulting in distortion of the wire rope structure such as:
- d. Evidence of heat damage.
- e. End attachments that are cracked, deformed worn.
- f. Corrosion of the rope or end attachments.

v. Metal mesh slings must be immediately removed from service if any of the following conditions are present:

- a. A broken weld or broken brazed joint along the sling edge.
- b. Reduction in wire diameter of 25 percent due to abrasion or 15 percent due to corrosion.
- c. Lack of flexibility due to distortion or corrosion.

vi. Synthetic web slings must be removed from service and destroyed if any of the following conditions are present:

- a. Acid or caustic burns
- b. Melting or charring of any part of the sling service
- c. Snags, punctures, tears or cuts
- d. Broken stitches
- e. Distortion of fittings

vii. Requirements of Plate Clamps:

1. The rated load of the plate clamp must be marked on the main structure.
2. Care must be taken to make certain the load is correctly distributed for the plate clamp being used.
3. Do not allow load or plate clamp to come into contact with any obstruction.
4. The plate clamp must not be used for side pulls or sliding the load.
5. When lifting stainless steel or special alloys, ensure plate clamp is designed for use on



POWER
SECTOR

HEALTH, SAFETY AND ENVIRONMENT PLAN FOR SITE OPERATIONS (SECTION-A)

Doc. No.: HSEP:14-
ER
Rev.: 01
Date:08.05.20
Page 64 of 170

the specific metal.

13.2.4.4.3 SIGNALING PRACTICES:

- The "slinger" is responsible for attaching and detaching the load to and from the crane. He shall:
 - have received appropriate training on general safe lifting operations;
 - be capable of selecting lifting gears suitable for the loads;
 - liaise with the operator and direct the movement of the crane safely.
- The "signaller" is responsible for relaying the signal from the slinger to the crane operator. He shall:
 - have received appropriate training on general safe lifting operations;
 - be able to direct the movement of the crane and loads.

Suggested hand signals



Note: During the lifting operation, either the slinger or signaller shall communicate with the operator. Other communication methods (e.g., wireless walkie-talkies, telephones, etc.) may also be used.

Fig. 13.2.4.4 Recommended Signalling Practices



**POWER
SECTOR**

**HEALTH, SAFETY AND ENVIRONMENT PLAN
FOR
SITE OPERATIONS
(SECTION-A)**

Doc. No.: HSEP:14-
ER

Rev.: 01

Date:08.05.20

Page 65 of 170

13.2.5 DEMOLITION WORK

Before any demolition work is commenced and also during the process of the work the following shall be ensured, besides using the Work Permit:

1. All roads and open areas adjacent to the work site shall either be closed, suitably protected or restricted for movement
2. No electric cable or apparatus which is liable to be a source of danger nor a cable or an apparatus used by the operator shall remain electrically charged.
3. All practical steps shall be taken to prevent danger to persons employed from the risks of fire or explosion or flooding. No floor, roof or other part of the building shall be so overloaded with debris or materials as to render them unsafe.

13.2.6 T&Ps General

1. All T&Ps/ MMEs should be of reputed brand/appropriate quality & must have valid test /calibration certificates bearing endorsement from competent authority of BHEL.
2. Subcontractor to also submit monthly reports of T&Ps deployed and validity test certificates to BHEL safety Officer as per the format/procedure of BHEL.
3. Tagging and punching in all lifting tool is compulsory with SWL, sr. no. and due date.
4. All T&Ps shall be inspected by authorized Third Party agency as per applicable frequency. BHEL shall be kept informed of any such scheduled inspection
5. All T&Ps shall be internally inspected in each quarter and colour coded as below.

13.2.6.1 T&P Color Coding Procedure:

Inspections and tests shall be documented by means of color coding which shall verify that inspections or testing are current and that all receptacles, portable Power tools, Lifting Tools & Tackles have been inspected and tested as required. The color codes used on the project shall be:

GREEN	BLUE	YELLOW	RED
January February March	April May June	July August September	October November December

Table. 13.2.6.1 T&P Color Coding Procedure

- i. The cycle of colors shall be Quarterly as a minimum or as decided by BHEL. The color code tape / Sticker shall be clearly visible to designate the period for which the inspections and tests were conducted.



**POWER
SECTOR**

**HEALTH, SAFETY AND ENVIRONMENT PLAN
FOR
SITE OPERATIONS
(SECTION-A)**

Doc. No.: HSEP:14-ER
Rev.: 01
Date:08.05.20
Page 66 of 170

- ii. Following the initial inspection, the equipment must be color-coded quarterly as per color-coding instructions that will be issued by the subcontractor.
- iii. Fire extinguisher with the current month color-coding inspection sticker must be provided and secured in the platform.
- iv. All slings shall be regularly inspected in accordance with the requirement of the project for frequent and periodic inspections and discard immediately if they fail to meet the minimum requirements of the project.
- v. The Subcontractor's Safety Officer shall ensure that all PPE is inspected prior to its issue. He is to ensure all subcontractor personnel are using safe and proper PPE equipment. Regular inspections on the PPE shall be carried out and personnel not adhering to those inspections shall be removed immediately from the site.
- vi. A five (10) day interval period shall be given into each monthly color code change. During this five (10) day period either color shall be acceptable.

13.2.7 CHEMICAL HANDLING

1. Displaying safe handling procedures & MSDS for all chemicals such as lube oil, acid, alkali, sealing compounds etc, at work place.
2. Where it is necessary to provide and/or store petroleum products or petroleum mixture & explosives, the subcontractor shall be responsible for carrying out such provision / storage in accordance with the rules & regulations laid down in the relevant petroleum act, explosive act and petroleum and carbide of calcium manual, published by the chief inspector of explosives of India. All such storage shall have prior approval if necessary from the chief inspector of explosives or any other statutory authority. The subcontractor shall be responsible for obtaining the same.
3. The used containers of chemicals shall be segregated and disposed off suitably
4. In case the used containers need to be re-used, all traces of the chemical to be removed by thorough cleaning with detergents etc. under trained supervision

13.2.8 ELECTRICAL SAFETY

1. Only electricians licensed by appropriate statutory authority shall be employed by the subcontractor to carry out all types of electrical works. The subcontractor shall maintain adequate number of qualified electricians to maintain his temporary electrical installations.
2. Power supply to all equipment at site to be routed through MCBs of appropriate rating. A 'Power Supply Distribution Plan' shall be prepared and submitted to BHEL Engineer for approval



**POWER
SECTOR**

**HEALTH, SAFETY AND ENVIRONMENT PLAN
FOR
SITE OPERATIONS
(SECTION-A)**

Doc. No.: HSEP:14-
ER

Rev.: 01

Date:08.05.20

Page 67 of 170

3. All power supplies through cables shall be underground or overhead with height > 3mtrs.
4. All distribution boxes shall be locked and the key controlled by site management of concerned subcontractor.
5. All individual equipment & tools at site shall be powered through Earth Leakage Circuit Breakers of 30 mA sensitivity.
6. These MCBs and ELCBs shall be regularly tested as per Clause 14
7. All fuses and fuse wires shall be of standard size and rating.
8. All electrical appliances used in the work shall be in good working condition and shall be properly double earthed other than armour earthing.
9. All extension boards shall have separate switches for all sockets / connections
10. All portable electric tools used by the subcontractor shall have safe plugging system to source of power and be appropriately earthed.
11. Providing adequate no. of 24 V sources and ensure that no hand lamps are operating at voltage level above 24 Volts especially in confined spaces like inside water boxes, turbine casings, condensers etc.
12. Electrical appliance shall have proper earthing and for appliances equal to & more than 415V shall have two separate earthing (as per IS-3043-1987)
13. Details of earth resource and their test date to be given to BHEL safety officer as per the prescribed formats of BHEL
14. The subcontractor shall use only properly insulated and armoured cables and conform to the requirement of Indian Electricity Act and Rules for all wiring, electrical applications at site.
15. BHEL reserves the right to replace any unsafe electrical installations, wiring, cabling etc. at the risk & cost of the subcontractor.
16. No maintenance work shall be carried out on live equipment
17. Adequate precautions shall be taken to prevent danger for electrical equipment. No materials on any of the sites of work shall be so stacked or placed as to cause danger or inconvenience to any person or the public
18. The subcontractor shall carefully follow the safety requirement of BHEL/ the purchaser with the regard to voltages used in critical areas.
19. Wiring and Branch Circuits Must be protected by a proper amperage over-current device such as a HRC fuse or circuit breaker. Such installations must be located so as to prevent physical damage to the wire conductors & panels.

20. Portable Electric Lights

- a. Portable electric lights used in wet or potentially wet locations must be either low voltage type (24 volts or less) or protected by a GFI (ground fault interrupter).
- b. They must be visually checked before each use and periodically while in use to assure their original integrity is maintained.
- c. Cords with cuts, breaks, deep abrasions, etc. shall be taken out of service immediately.
- d. Repairs to extension cords shall only be performed by qualified/ licensed electricians.
- e. Must not be allowed to lie in wet or potentially wet areas.



**POWER
SECTOR**

**HEALTH, SAFETY AND ENVIRONMENT PLAN
FOR
SITE OPERATIONS
(SECTION-A)**

Doc. No.: HSEP:14-
ER

Rev.: 01

Date:08.05.20

Page 68 of 170

21. Underground Cables:

- a. Every electric line or cable of unknown origin that is discovered or exposed during a digging, drilling, probing, or similar operation is to be considered as energized and life threatening.
 - b. The senior company employee on the site will ensure that all necessary safety precautions are taken in order to isolate the line from all workers and the public.
 - c. Such precautions may include halting the operation if appropriate.
 - d. The senior company employee on the site is to then contact the proper authorities to have the line identified and either confirmed to be abandoned and/or made safe for continuing the work.
 - e. Any and all underground lines that are discovered or become severed must be considered energized on both sides, and be treated accordingly.
22. In general, equipment or machinery being moved or transported must maintain minimum clearances of 25 ft. to all power lines.
 23. TAG IN/ TAG OUT must be in force in Switch Room and all Distribution Boxes for live power line. The authorized person's name and contact no shall be displayed
 24. Ensure "double insulated" three - core cables and three pin connectors are used and are properly ground "all insulated" types, all electrical tools and appliances must be manufactured for industrial use.
 25. All connections shall be electrically and mechanically sound and properly insulated. Taped joints are not permitted. Connections to socket outlets must be made with proper plugs.
 26. Splices in electrical cords are not permitted. Repairs must be made at the socket connection and retain the same mechanical and dielectric condition of the original connection.
 27. Damaged or defective electric tools, equipment and extension cords, etc. must not be used and shall be tagged out of service, removed from the work area and taken back to stores.
 28. Only licensed electricians are authorized to repair and work on electrical equipment. Tampering with electric tools or equipment by others could result in termination.
 29. Temporary electric cabling should be elevated 2.2 meters above the floor/ground or covered for protection. It must be kept clear of walkways and other locations where it may be exposed to damage or create a tripping hazard.
 30. Energized wiring in junction boxes, circuit breaker panels and similar places must be covered and locked at all times.
 31. Areas with live high voltage wires or terminals must be barricaded against entry and warning signs posted Danger – High Voltage and Authorized Personnel Only.
 32. Personnel should never work on energized equipment, de-energizing (lockout/tag out) the equipment is always the first requirement.
 33. The lockout and tag out procedure will be used when testing or working on, or around, energized installation.
 34. Working around energized equipment should never be done alone. A second electrician must always be available for assistance.



**POWER
SECTOR**

**HEALTH, SAFETY AND ENVIRONMENT PLAN
FOR
SITE OPERATIONS
(SECTION-A)**

Doc. No.: HSEP:14-
ER

Rev.: 01

Date:08.05.20

Page 69 of 170

35. If lockout/tag out of the work is infeasible (must be demonstrated), work on energized electrical circuits must be approved by the Site In-charge. All safety precautions necessary must be taken, PPE use must be evaluated per the exposure and used, i.e high/low voltage gloves, insulated shoes, overcoats/aprons, face shields, and other protective equipment like insulated tools, blankets, mats, etc. must be used.
36. The welding machines earth leads shall be properly fixed without loose contacts. The earth cable only has to be used. No steel members shall be used as earth leads.
37. Electrical crews must be qualified for the equipment and tools they work on, including being trained in Cardio-Pulmonary Resuscitation (CPR) methods and First Aid for rendering help in the event of electric shock.

38. Qualified Persons for Electrical Works

One who is trained and wiremen licensed to Govt of State and familiar with the construction, operation and safety hazards of the equipment upon which they are permitted to work.

- i. Qualified persons are intended to be only those who are well acquainted/experienced with and thoroughly conversant in the electric equipment and electrical hazards involved with work being performed.
- ii. Only qualified persons may be permitted to work on or near exposed energized parts. Such persons are required to have been trained in three specific areas:
- iii. Qualified persons must be capable of working safely on energized circuits;
- iv. Must be familiar with the proper use of special precautionary techniques and procedures based on equipment and exposure; and
- v. Must be familiar with required personal protective equipment, insulating and shielding materials, and insulated tools.
- vi. Qualified persons are expected to be able to evaluate unknown situations and adjust their activities in such a way that only safe work practices are used. Such behavior is the responsibility of the qualified person.
- vii. It is possible and likely for an individual to be 'qualified' with regard to certain equipment in the work place, and unqualified on other equipment they must know their limitation and stop work if not qualified on what equipment they were to work on.
- viii. An employee who is undergoing on-the-job training, who, in the course of such training, has demonstrated an ability to perform duties safely at his or her level of training, and who is under the direct supervision of a qualified person is considered to be a qualified person for the performance of those duties. The process must be documented as proof.

13.2.9 USE OF HAND TOOLS AND POWER-OPERATED TOOLS

13.2.9.1 General Provisions

- a. All hands and power tools and similar equipment, shall be maintained in safe condition.
- b. When power operated tools are designed to accommodate guards, they shall be equipped
- c. with such guards, when in use;
- d. Belts, gears, shafts, pulleys, sprockets, spindles, drums, fly wheels, chains and other reciprocating, rotating or moving parts of the equipment shall be similarly guarded;
- e. Personnel using hand and power tools and exposed to the hazard of falling, flying, abrasive, and splashing objects, or exposed to harmful dusts, fumes, mists, vapors, or gases shall be



**POWER
SECTOR**

**HEALTH, SAFETY AND ENVIRONMENT PLAN
FOR
SITE OPERATIONS
(SECTION-A)**

Doc. No.: HSEP:14-
ER

Rev.: 01

Date:08.05.20

Page 70 of 170

provided with the particular personal protective equipment necessary to protect them from the hazards;

- f. All hand-held powered platen sanders, grinders, grinders with wheels of 5 cm or less, routers, planers, laminate trimmers, nibblers, shears, scroll saws and jigsaws with blade shanks of 0.5 cm wide or less shall be equipped with only a positive on-off control.
- g. All hand-held powered drills, tappers, fastener drivers, horizontal, vertical or angle grinders with wheels greater than 5 cm in diameter, disc sanders, belt sanders, reciprocating saws, saber saws and other operating powered tools shall be equipped with a momentary contact on control provided that turnoff can be accomplished by a single motion of the same finger or fingers that turn it on.

13.2.9.2 Hand Tools

- a. The subcontractor shall not issue or permit the use of unsafe hand tools;
- b. Wrenches including adjustable pipe end and socket wrenches shall not be used when saws are sprung to the point that slippage occurs;
- c. Impact tools such as drift pins, wedges and chisels shall be kept free of mushroomed heads;
- d. The wooden handles of tools shall be kept free of splinters or cracks and shall be kept tight on the tools.

13.2.9.3 Power Operated Tools

- a. Electric power operated tools shall be either of the approved double-insulated type or shall be grounded;
- b. The use of electric cords for hoisting or lowering loads shall not be permitted;
- c. Pneumatic power tools shall be secured to the hose or whip by some positive means to prevent the tool from becoming incidentally disconnected;
- d. Safety clips or retainers shall be securely installed or maintained on pneumatic impact (percussion) tools to prevent attachments from being incidentally expelled;
- e. All pneumatically riveting machine staplers and other similar equipment provided with automatic fastener feed, which operate at more than 7 kg/cm² pressure at the tool a safety device on the muzzle to prevent the tool from ejecting the fasteners unless the muzzle is in contact with the work surface;
- f. Compressed air shall not be used for cleaning purposes except when the pressure is reduced to less than 2 kg/cm² and that too with effective chip guarding. The 2 kg/cm² pressure requirement does not apply to concrete form, mill scale and similar cleaning purposes;
- g. The manufacturer's safe operating for hoses, pipes, valves, filters and other fittings shall not be exceeded;
- h. Only personnel who has been trained in the operation of the particular tool shall be allowed to operate power-actuated tools;
- i. The tool shall be tested each day before loading to see that the safety devices are in proper working condition. The method of testing shall be accordance with the manufacturer's



**POWER
SECTOR**

**HEALTH, SAFETY AND ENVIRONMENT PLAN
FOR
SITE OPERATIONS
(SECTION-A)**

Doc. No.: HSEP:14-
ER

Rev.: 01

Date:08.05.20

Page 71 of 170

recommended procedure;

- j. Any tool found not in proper working order, or that which develops a defect during use, shall be immediately removed from service and not used until properly repaired;
- k. Tools shall not be loaded until just prior to the intended firing time. Neither loaded nor empty tools are to be pointed at any other person. Hands shall be kept clear of the open barrel end;
- l. Loaded tools shall not be left unattended;
- m. Fasteners shall not be driven into very hard or brittle materials including, but not limited to, cast iron, glazed tiles, surface hardened steel, glass block, live rock, face brick or hollow tiles;
- n. Driving into materials that can be easily penetrated shall be avoided unless backed by a
- o. substance that will prevent the pin or fastener from passing completely through and creating a flying missile hazard on the other side;
- p. No fastener shall be driven into a palled area caused by an unsatisfactory fastening;
- q. Only non-sparking tools shall be used in an explosive or flammable atmosphere;
- r. All tools shall be used with the correct shield, guard or attachment as recommended by the manufacturer.

13.2.9.4 Abrasive Wheels and Tools

- a. All grinding wheel must be ISO certified only.
- b. All grinding machines shall be supplied with sufficient power to maintain the spindle speed at safe levels under all conditions of normal operation;
- c. Grinding machines shall be equipped with suitable safety guards;
- d. The maximum angular exposure of the grinding wheel periphery and sides shall not be more than 900, except that when the work requires contact with the wheel below the horizontal plane of the spindle, the angular exposure shall not exceed 1200. In either case, the exposure shall begin not more than 8.650 above the horizontal plane of the spindle. Safety guards shall be strong enough to withstand the bursting of the wheel;
- e. Floor and bench-mounted grinders shall be work-rests, which shall be rigidly supported and readily adjustable. Such work-rests shall be kept at a distance not to exceed 5 mm from the surface of the wheel;
- f. Cup type wheels used for external grinding shall be protected by either revolving cup guard or a band type guard;
- g. When safety guards are required, they shall be mounted as to maintain proper alignment with the wheel and the guard and the guard and its fastening shall be adequate strength to retain the fragments of the wheel in case of incidental breakage. The maximum angular exposure of the grinding wheel periphery and sides shall not exceed 1800;
- h. Portable abrasive wheel used for internal grinding shall be provided with suitable safety flanges;
- i. When safety flanges are required, they shall be used only with wheels designed to fit the flanges. Only safety flanges, of a type and design and properly assembled so as to ensure that the pieces of the wheel will be retained in case of incidental breakage, shall be used;
- j. All abrasive wheels shall be closely inspected and ring tested before mounting to ensure that



**POWER
SECTOR**

**HEALTH, SAFETY AND ENVIRONMENT PLAN
FOR
SITE OPERATIONS
(SECTION-A)**

Doc. No.: HSEP:14-
ER

Rev.: 01

Date:08.05.20

Page 72 of 170

they are free from cracks or defects;

- k. Grinding wheels shall fit freely on the spindle and shall not be forced on. The spindle nut shall be tightened only enough to hold the wheel in place;
- l. All employees using abrasive wheels shall be protected by suitable eye protection equipment.

13.2.9.5 Wood Working Tools

- a. All fixed power driven woodworking tools shall be provided with a disconnect switch that can either be locked or tagged in the off-position;
- b. The operating speed shall be attached or otherwise permanently marked on all circular saws over 0.5 m in diameter or operating at over 3000 peripheral rpm. Any saw so marked shall not be operated at a speed other than that marked on the blade. When a marked saw is re-tensioned for a different speed, the marking shall be corrected to show the new speed;
- c. Automatic feeding devices shall be installed on machines wherever the nature of the work will permit. Feeder attachments shall have the feed rolls or other moving parts covered or guarded so as to protect the operator from hazardous points;
- d. All portable power driven circular saws shall be equipped with guards above and below the base plate or shoe. The upper guard shall cover the saw to the depth of the teeth, except for the minimum arc required to permit the base to be tilted for bevel cuts. The lower guard shall cover the saw to the depth of the teeth, except for the minimum arc required to allow proper retraction and contact with the work. When the tool is withdrawn from the work, the lower guard shall automatically and instantly return to the covering position.

13.2.10 START UP, COMMISSIONING AND TESTING:

There are various activities involved prior to commissioning- the major ones are -Hydraulic Test, Steam Blowing, Transformers Charging, Boiler Light Up, Rolling and Synchronisation and Full loading of unit.

- a. These activities shall be personally supervised by the site executive along with the commissioning engineer.
- b. Appropriate Work Permits shall be taken as applicable
- c. The readiness of upstream and downstream system shall be ensured before taking up.
- d. These shall be handled strictly by the authorized persons only and the team shall be suitably briefed about the activity including hazards & risks involved and control plan by the concerned executive-in-charge before start.
- e. Entry of persons to the area of activity shall be suitably restricted and the emergency functions like Ambulance, first aid center and Fire station shall be intimated about the plan well in advance.
- f. Tag-in/ Tag-out shall be in place while charging transformer and whenever necessary.
- g. Electricians with valid wiremen license only shall be permitted to work on power lines.
- h. The area and the passage shall be adequately illuminated.



**POWER
SECTOR**

**HEALTH, SAFETY AND ENVIRONMENT PLAN
FOR
SITE OPERATIONS
(SECTION-A)**

Doc. No.: HSEP:14-
ER

Rev.: 01

Date:08.05.20

Page 73 of 170

13.2.11 FIRE SAFETY

Numbers and types of Fire Extinguishers shall be ensured as follows:

Sl. No	Type of Fire Risk (Class of Fire)	Extinguishing Medium & Relevant Indian Standard	Scale of Equipment (Minimum recommended)
1.	CLASS 'A' Fires involving ordinary combustible materials like wood, paper, textiles, rubber etc. (Ordinary hazard or low fire load)	WATER Soda acid type, water type (gas pressure) and water type (constant air pressure) IS: 934 -1976; IS: 940 -1976; IS: 6234 -1971	For every 600 square meter floor area or part, one 9-litre capacity. Minimum 4 numbers per floor or room; should not be required to travel more than 15 meter to reach any extinguisher.
2.	CLASS 'A' (Extra hazard & high fire load)	-do	-do – (Also, consult local fire authority).
3.	CLASS 'A' (Special hazards)	-do	-do – Extra provision For every 100 square meter floor area or part, one 4.5 Kg. CO ₂ ; minimum 2 numbers per room; should not be required to travel more than 10 meter to reach any extinguisher.
4.	CLASS 'B' (Fires in flammable liquids like oils, solvents, petroleum, products, varnishes, paints, etc. where blanketing effect is essential) (Storage and handling in small quantities)	FOAM / CARBON DIOXIDE / DRY CHEMICAL POWDER IS: 933 -1976; IS: 2878 1976; IS: 2171 1976; IS: 4308 -1982	For every 50 square meter floor area or part, 2 numbers 9 -liters foam or 5 kg dry powder; should not be required to travel more than 10 m in the area of storage to reach any extinguisher.
5.	CLASS 'B' (Bulk storage other than in tank form)	-do -	-do- (but minimum 3 numbers per room)
6.	CLASS 'C' (Fires involving gaseous substances under pressure where it is necessary to dilute the burning gas at a very fast rate with an inert gas or powder) (locations of storage and handling of gas cylinders)	CARBON DIOXIDE / DRY CHEM. POWDER. The best way to extinguish such fire is by stopping the flow of fuel gas to the fire. Container is kept cool with water spray. IS: 2878 1976; IS: 2171 -1976; IS: 4308 -1982	For every 100 square meter floor area or part; 2 numbers, 10 kg powder extinguisher or 6 kg CO ₂ ; minimum 3 nos. per room; should not be required to travel more than 10 meter to reach any extinguisher.
7.	CLASS 'D' Fires involving metals like magnesium, aluminum, zinc, potassium etc. where the burning metal is reactive to water and which require special extinguishing media or technique	SPECIAL DAY POWDER IS: 2171 -1976 IS: 4861 -1968	For every 50 square meter floor area or part, 2 nos. 5 kg special dry powder; minimum 3 nos. per room; should not be required to travel more than 10 meter to reach any extinguisher.
8.	MIXED OCCUPANCY (electrical); Generators; Transformers; etc.	CARBON DIOXIDE DRY POWDER, IS: 2878 -1976; IS: 2171 -1976	For every 100 square meter floor area or part one 10 kg CO ₂ . Minimum 2 numbers for every location should not be required to travel more than 10 meter to reach an extinguisher.

Note: Due to peculiarities of the power plant construction sites, there would be locations in the construction areas of Boiler, Turbine, Generator, Transformer, etc. where different types of fire risk (classes of fire) may co-exist. Special



**POWER
SECTOR**

**HEALTH, SAFETY AND ENVIRONMENT PLAN
FOR
SITE OPERATIONS
(SECTION-A)**

Doc. No.: HSEP:14-
ER

Rev.: 01

Date:08.05.20

Page 74 of 170

care shall be taken while selecting and installing portable fire extinguishers for such locations so that all types of fire risk that may co-exist, are adequately covered. Similar special care shall be taken for storage areas.

1. All Electrical welding booths shall be equipped with appropriate Fire Extinguisher
2. Appropriate Fire Extinguishers shall be made within easy reach of all welding operations
3. Fire extinguishers shall be regularly tested and last checked date to be indicated on each.
4. Providing appropriate firefighting equipment at designated work place and nominate a fire officer/warden adequately trained for his job.
5. Subcontractor shall provide enough fire protecting equipment of the types and numbers at his office, stores, temporary structure in labour colony etc. Such fire protection equipment shall be easy and kept open at all times.
6. The fire extinguishers shall be properly refilled and kept ready which should be certified at periodic intervals. The date of changing should be marked on the Cylinders.
7. All other fire safety measures as laid down in the "codes for fire safety at construction site" issued by safety coordinator of BHEL shall be followed.
8. Non-compliance of the above requirement under fire protection shall in no way relieve the subcontractor of any of his responsibility and liabilities to fire incident occurring either to his materials or equipment or those of others.
9. Emergency contacts nos. must be displayed at prominent locations
10. Tarpaulin being inflammable should not be used (instead, only non-infusible covering materials shall be used) as protective cover while preheating, welding, stress relieving etc. at site.

13.2.12 HSE PREPAREDNESS FOR ADVERSE CLIMATES AND WEATHER

Subcontractor to remain updated on possible adverse weather conditions through reliable sources and all precautions taken accordingly.

13.2.12.1 SUMMER

1. The Working Time and Lunch Hour will be as per instruction of Statutory Authorities (no work between 11am to 3:30pm). However, in case temp comes down due to rain/cloudy weather work will continue as per normal routine.
2. During long lunch break, worker will be allowed to go back home for rest. Those who will like to stay back will avail at the facility of rest shed or other designed area.
3. They will be allowed to take small break during work as per their need.
4. Water sprinkling will be done on roads to reduce dust concentration.
5. Workers will be provided with adequate cool drinking water and Butter milk/Lemon water etc.
6. Adequate ORS stock will be made available at the work location in the First-Aid Box for use as needed and at First-aid Center for emergency need.
7. Fire prevention shall be on high alert, with removal of dry grass and bushes, etc, inside and outside the surrounding work areas. No smoking, and control of open flame/sparks shall be maintained and monitored.
8. Worker will be informed about the Do's and Don'ts to be followed during summer in the Pre Job Brief.



**POWER
SECTOR**

**HEALTH, SAFETY AND ENVIRONMENT PLAN
FOR
SITE OPERATIONS
(SECTION-A)**

Doc. No.: HSEP:14-
ER

Rev.: 01

Date:08.05.20

Page 75 of 170

Do's & Don'ts

9. Drink plenty of cool water and other non-alcoholic fluid and keep body well hydrated.
10. Eat salt in food to replenish loss of salt through sweating.
11. Avoid over physical exercise.
12. Have adequate sleep at night.
13. Eat light and less spicy food
14. Avoid eating food which was cooked long time ago.
15. Nobody should use small water bodies such as pits, running rain water through crevices etc. for drinking and cleaning purpose as it may be unhygienic.

Emergency Handling

In case of emergency due to heat disorder:

16. Rescue the victim from workplace and place under shed.
17. If to be rescued from height, use stoke basket or rescue kit.
18. Inform Ambulance immediately.
19. If nearby any air conditioned room/shed is available, place him inside the room/shed.
20. Administer First aid by trained First aider for Heat Disorder
21. If conscious, give him ORS solution to drink.
22. If required send the victim hospital immediately.

13.2.12.2 Monsoon

A. Height Work & Structural Safety:

1. Ensure that all height work platforms are barricaded and avoid any highly hazardous
2. height work.
3. Ensure that all personnel have good quality and intact safety shoes
4. Stop all dangerous height work during rain
5. Explain Do's and Don'ts to workers during Tool Box Meetings
6. Ensure that there are no weak structures, boards etc. that can fall during high winds
7. Do not allow any loose material (e.g. GI sheet, Ply board, empty cement bag, aluminum foil, foam sheets etc.) on roof sheds or top of structures.
8. Do not permit any one to ride up or come down scaffolds frame work during heavy wind or rain.
9. Provide "anchor" of adequate strength to scaffolds and other high-rise structures.
10. All rest sheds and GI sheds will be anchored into the round and wall and roof panels will be secured with J hook to prevent shed from blowing over or parts/pieces becoming airborne. Proper earthing per IS standard is also to be installed.
11. Do not go alone nor permit anyone to stay at tower-tops, roof-tops, high structures or on electrical poles during the course of stormy weather or heavy rain.



**POWER
SECTOR**

**HEALTH, SAFETY AND ENVIRONMENT PLAN
FOR
SITE OPERATIONS
(SECTION-A)**

Doc. No.: HSEP:14-
ER

Rev.: 01

Date:08.05.20

Page 76 of 170

B. Electrical:

1. All electrical connections / loads have to be routed through ELCB / RCCB (residual current circuit breaker) whose rating should be 30mA.
2. RCCB operational checks need to be done DAILY / WEEKLY during monsoon season.
3. Avoid joints on power cables which need to be laid over-head or under-ground, better not to have any joint at all. In case joints become essential, such cables must be housed rigidly and insulation must be provided as per approved standard. The joint shall be suitable for outdoor use.
4. All electrical distribution board shall be properly covered at top and sides to protect from rain water. Extension boards shall be protected from rain water.
5. Ensure proper "earthing" for each and every electrical appliance.
6. Double earthing need to be provided for 3-phase power supply and for voltage more than 220V.
7. Provide lightening arrestors at the top of Boiler 3 and boiler 4 and rest sheds which are not covered by existing lightening arrestor of other installation.

C. Others:

1. Maintain smooth flow on open drains. i.e. no obstruction or blockade shall be made on storm water drains. If required, make temporary drains.
2. Arrange back-filling of excavated pits on war-footing basis.
3. Arrange bringing down booms of all cranes, hydra machines during stormy weather (wind speed 40-50 kmph)
4. Confirm that all gantry cranes are effectively choked to prevent rolling and toppling.
5. Do not forget to deep ready a dew battery operated lights at site-offices during rainy season.
6. Avoid using wet damp clothes.
7. Barricade excavated zone filled with water.
8. Engage diesel operated water pump to dewater work area. For electrically operated water pump, the starter shall be protected from rain water. All rotating parts shall be guarded. Ensure availability of sufficient water pumps.

D. Health and hygiene:

1. Monsoon reduces the immunity of our body and makes us vulnerable to many diseases which are commonly associated with this season. It is time for us to keep our body challenging against disease by boosting our immunity and taking safety measures against these diseases.



**POWER
SECTOR**

**HEALTH, SAFETY AND ENVIRONMENT PLAN
FOR
SITE OPERATIONS
(SECTION-A)**

Doc. No.: HSEP:14-
ER

Rev.: 01

Date:08.05.20

Page 77 of 170

2. The diseases associated with monsoon are Malaria, Jaundice, Gastro-intestinal infections, like typhoid, cholera etc. apart from these viral infections like cold and cough also make their presence felt. Majority of above said diseases are on account of:
3. Puddle of water formed due to rain become breeding grounds for mosquitoes which spread disease like, malaria and dengue fever. As a precautionary measure against mosquito-bite disease one can use mosquito net around the end which is better choice to mosquito repellants like mats and coils.
4. Pollution of drinking water during monsoon is very common. It is very necessary to drink clean and pure water when water-borne monsoon diseases like diarrhea and gastro-intestinal infections threaten us.
5. Walking in dirty water during rainy season leads of numerous fungal infection which affect toes and nails. Diabetic patients have to take a special care about their feet. Keeping feet always dry and clean is very necessary. Avoid walking in dirty water. Keep shoes socks and raincoats dry and clean.

E. Workmen will be made aware of following Do's and Don'ts:

1. Do not sleep in daytime.
2. Avoid over physical exertion.
3. During lightning and thunder storm, do not take shelter under tree. Take shelter inside rest shed or store room.
4. Wash vegetables with clean water and steam them well to kill germs.
5. Avoid eating un-cooked foods and salads should be washed properly before consumption.
6. Drink plenty of water and keep body well-hydrated.
7. Always keep the surrounding area dry and clean. Don't allow to get water accumulated around.
8. Keep body warm as viruses attack immediately when body temperature goes down.
9. Do not enter air conditioned room with wet hair and damp cloths.
10. Dry your feet and webs with soft dry cloth whenever they are wet.
11. Eat light and less spicy food.
12. Avoid eating food which was cooked long time ago.
13. Eat salt in food to replenish loss of salt through sweating.

13.2.12.3 Emergency Weather Conditions

A. Cyclone/Severe thunder storm

In the event of Cyclone/Severe thunder storm, alert will be issued by subcontractor on notification received by Govt. authorities/Metrological departments Customer or BHEL.

The actions required during cyclone/rough weather:

1. Check and advice subcontractors to cleanup work area. Pick up all loose and unused material of respective supervisor's area.
2. Tie to secure all gas cylinders to avoid displacement and unsafe conditions which could be due to wind pressure.



**POWER
SECTOR**

**HEALTH, SAFETY AND ENVIRONMENT PLAN
FOR
SITE OPERATIONS
(SECTION-A)**

Doc. No.: HSEP:14-ER
Rev.: 01
Date:08.05.20
Page 78 of 170

3. Secure portable electricity generating sets and other equipment, pumps, hoses etc.
4. Make preparation for removal of water logging.
5. Take review of work activity and make preparation for removal of equipment and material from vulnerable areas.
6. Isolate/turn off all electrical power from the main panel/switches. Secure and anchor panels properly.
7. Recheck anchorage/tie of all temporary structures/sheds, tall objects, cranes, rigs, scaffolds etc. to avoid toppling due to wind force.
8. Cranes boom shall be secured, either locked or lowered the booms as reasonably and practicably possible and rigs to safe position for the safety point of view.
9. Group up all trash barrels, wooden pallets, forms; wooden decks etc. and anchor properly.
10. Welding machines, air compressors and such equipment are to be grouped together and secured to the stable objects. Welding leads, electrical cables, hoses are to be rolled up and secured properly.
11. Set on site vehicles on high ground in the site area with brakes set firmly.
12. Anchor all tanks, vessels, gas cylinders that may be moved by high wind and water.
13. Evacuate job site.

Personnel Evacuation:

14. Personnel Evacuation will be required if predicted wind speed and storm surge heights are beyond acceptable limits as per the instructions from Govt. Authorities/ Metrological departments or Customer.
15. Once the warning is received for personnel evacuation, an emergency response team shall be formed. The team will work with local authorities and other agencies formed/deployed to evacuate and transport all personnel involved in the project to the cyclone shelter.
16. Cyclone may be followed by the calm "EYE", be aware of it. If the wind suddenly drops, don't assume the cyclone is over. Violent wind may resume from the opposite side direction. Wait for the official "All clear Signal".
17. After the cyclone, do not go outside until officially communicated about safe situation outside. Use recommended routes for returning. Do not panic or rush while returning.
18. Checking of gas leaks and well being of electrical appliances is essential before leaving the site.
19. Follow local communications for official warning and advice. The construction Manager shall also obtain updates from customer/metrological departments and communicate to the personnel on project site.

13.2.12.4 Preparedness for Other Adverse Climates and Weather Conditions

All Preventive and Precautionary measures to ensure Health & Safety of workers in all possible adverse weather conditions based on the analysis of the local area conditions to be taken by the subcontractor

13.3 ENVIRONMENTAL CONTROL

1. Environment protection has always been given prime importance by BHEL. Environmental



**POWER
SECTOR**

**HEALTH, SAFETY AND ENVIRONMENT PLAN
FOR
SITE OPERATIONS
(SECTION-A)**

Doc. No.: HSEP:14-
ER

Rev.: 01

Date:08.05.20

Page 79 of 170

damage is a major concern of the principal subcontractor and every effort shall be made, to have effective control measures in place to avoid pollution of Air, Water and Land and associated life.

2. Subcontractor shall list out all applicable environmental aspects and impacts, and ensure control measures to manage the same.
3. Chlorofluorocarbons such as carbon tetrachloride and trichloroethylene shall not be used.
4. Waste disposal shall be done in accordance with the guidelines laid down in the project specification.
5. Any chemical including solvents and paints, required for construction shall be stored in designated bonded areas around the site as per MSDS.
6. In the event of any spillage, the principle is to recover as much material as possible before it enters drainage system and to take all possible action to prevent spilled materials from running off the site. Subcontractor shall use appropriate MSDS for clean-up technique. Subcontractor shall be responsible for the cleanliness of their own areas.
7. Subcontractor shall ensure that noise levels generated by plant or machinery are as low as reasonably practicable. Where the subcontractor anticipates the generation of excessive noise levels from his operations the subcontractor shall inform BHEL accordingly so that reasonable & practicable precautions can be taken to protect other persons who may be affected.
8. It is imperative on the part of the subcontractor to join and effectively contribute to environmental protection measures such as tree plantation and towards social causes and maintaining good relations with local populace.
9. The subcontractor shall carry out periodic air and water quality check and illumination level checking in respective area of work place and take suitable control measure to maintain the same as per applicable laws / standards

13.3.1 WASTE MANAGEMENT

1. Subcontractor shall take suitable measures for waste management and fulfilling requirements of environment related laws/legislation as a part of normal construction activities.
2. Compliance with the legal requirements on storage/ disposal of paint drums (including the empty ones), Lubricant containers, Chemical Containers, and transportation and storage of hazardous chemicals will be strictly maintained.
3. Details of E-Waste, Hazardous Waste, shall be submitted to BHEL as per Format No. HSEP: 14-F18 and HSEP: 14-F19 respectively

13.3.1.1 BINS AT WORK PLACE

1. Sufficient rubbish bins shall be provided close to workplaces.
2. Bins should be painted yellow and numbered.
3. Sufficient nos. of drip trays shall be provided to collect oil and grease.
4. Sufficient qty. of broomsticks with handle shall be provided.
5. Adequate strength of employees should be deployed to ensure daily monitoring and service for waste management.

13.3.1.2 STORAGE AND COLLECTION

1. Different types of rubbish/waste should be collected and stored separately.



**POWER
SECTOR**

**HEALTH, SAFETY AND ENVIRONMENT PLAN
FOR
SITE OPERATIONS
(SECTION-A)**

Doc. No.: HSEP:14-
ER

Rev.: 01

Date:08.05.20

Page 80 of 170

2. Paper, oily rags, smoking material, flammable, metal pieces should be collected in separate bins with close fitting lids.
3. Rubbish should not be left or allowed to accumulate on construction and other work places.
4. Do not burn construction rubbish near working site.

13.3.1.3 SEGREGATION

1. Earmark the scrap area for different types of waste.
2. Store wastes away from building.
3. Oil spill absorbed by non-combustible absorbent should be kept in separate bin.
4. Clinical and first aid waste stored and incinerated separately.

13.3.1.4 DISPOSAL

1. Sufficient containers and scrap disposal area should be allocated.
2. All scrap bin and containers should be conveniently located.
3. Provide self-closing containers for flammable/spontaneously combustible material.
4. Keep drainage channels free from choking.
5. Make schedule for collection and disposal of waste.

13.3.1.5 WARNING AND SIGNS

1. Appropriate signage to be displayed at scrap storage area
2. No toxic, corrosive or flammable substance to be discarded into public sewage system.
3. Waste disposal shall be in accordance with best practice.
4. Comply with all the requirements of Pollution Control Board (PCB) for storage and disposal of hazardous waste.

13.4 HOUSEKEEPING

1. Keeping the work area clean/ free from debris, removing unused scaffoldings, scraps, insulation/ sheeting wastage /cut pieces temporary structures, packing woods etc. will be in the scope of the subcontractor.
2. Such cleaning has to be done by subcontractor within quoted rate, on daily basis by dedicated identified groups equipped with all require PPEs and training. The details of housekeeping group shall be provided to BHEL.
3. If such activity is not carried out by subcontractor / BHEL is not satisfied, then BHEL may get it done by other agency and actual cost along with BHEL overheads will be deducted from subcontractor's bill. Such decisions of BHEL shall be binding on the subcontractor.
4. Pests, such as beehives etc. shall be periodically removed in a humane fashion
- 5. Following are to be taken care of on daily basis.**
 - i. All surplus earth and debris are removed/disposed of from the working areas to identified locations.
 - ii. Unused/Surplus cables, steel items and steel scrap lying scattered at different places /elevation within the working areas are removed to identify locations.
 - iii. All wooden scrap, empty wooden cable drums and other combustible packing materials, shall



**POWER
SECTOR**

**HEALTH, SAFETY AND ENVIRONMENT PLAN
FOR
SITE OPERATIONS
(SECTION-A)**

Doc. No.: HSEP:14-
ER

Rev.: 01

Date:08.05.20

Page 81 of 170

be removed from workplace to identified locations. Sufficient waste bins shall be provided at different work places for easy collection of scrap/waste. Scrap chute shall be installed to remove scrap from high locations

- iv. Access and egress (stair case, gangways, ladders etc.) path should be free from all scrap and other hindrances.
- v. Workmen shall be educated through tool box talk about the importance of housekeeping and encourage not to litter.
- vi. Labor camp area shall be kept clear and materials like pipes, steel, sand, concrete, chips and bricks, etc. shall not be allowed in the camp to obstruct free movement of men and machineries.
- vii. Fabricated steel structures, pipes & piping materials shall be stacked properly.
- viii. No parking of trucks/trolleys, cranes and trailers etc. shall be allowed in the camp, which may obstruct the traffic movement as well as below LT/HT power line.
- ix. Utmost care shall be taken to ensure over all cleanliness and proper upkeep of the working areas

13.5 TRAFFIC MANAGEMENT

13.5.1 SAFE WORKPLACE TRANSPORT SYSTEM

1. Traffic routes in a work place shall be suitable for the persons or vehicles using them.
2. Traffic routes for pedestrians and vehicles shall be clearly demarcated and indicated
3. Traffic routes shall never intersect the area of work and shall not endanger the site personnel
4. For internal traffic, lines marked on roads / access routes and between buildings shall clearly indicate where vehicles are to pass.
5. Temporary obstacles shall be brought to the attention of drivers by warning signs / hazard cones.
6. Power cables shall be maintained at a minimum height above ground as specified in Indian Electricity Act & Rules.
7. Sensible speed limits shall set and clearly displayed. Painted Speed ramps preceded by a warning signs or marker are necessary for stretches of roads exceeding 50 meters.
8. The traffic route should be wide enough to allow vehicles to pass and re-pass oncoming or parked traffic and it may be advisable to introduce on-way system or parking restrictions.
9. Safest route shall be provided between places where vehicles have to call or deliver.
10. Avoid vulnerable areas/items such as fuel or chemicals tanks or pipes, open or unprotected edges and structures likely to collapse
11. Safe areas shall be provided for loading and unloading of material. Loading / Unloading Permit shall be taken from BHEL prior to any significant loading / unloading activity
12. Avoid sharp or blind bends. If this is not possible hazards should be indicated e.g. blind corner.
13. Ensure road crossings are minimum and clearly signed.
14. Entrance and gateways shall be wide enough to accommodate a second vehicle without causing obstruction.
15. Forklift trucks shall not pass over road hump unless of a type capable of doing so.



**POWER
SECTOR**

**HEALTH, SAFETY AND ENVIRONMENT PLAN
FOR
SITE OPERATIONS
(SECTION-A)**

Doc. No.: HSEP:14-
ER

Rev.: 01

Date:08.05.20

Page 82 of 170

16. Overhead electric cable, pipes containing flammable hazardous chemical shall be shielded by using goal posts height gauge posts or barriers.
17. The height of Power cables above areas of movement shall conform to Indian Electricity Rules
18. Road traffic signs shall be provided on prominent locations for prevention of accidents and hazards and for quick guidance and warning to employees and public.
19. Safety signs shall be displayed as per the project working requirement and guideline of the state in which project is done.
20. Vehicles hired or used shall not be parked within the 15m radius of any working area. Any vehicle, that is required to be at the immediate/near the vicinity, shall be approved by the person in-charge of the site.

13.5.2 TRAFFIC ROUTE FOR PEDESTRIANS

1. Where traffic routes are used by both pedestrians and vehicles road shall be wide enough to allow vehicles and pedestrians safely.
2. Separate routes shall be provided for pedestrians to keep them away from vehicles. Provide suitable barriers/guard at entrances/exit and the corners or buildings.
3. Where pedestrian and vehicle routes cross, appropriate crossing shall be provided.
4. Where crowd is likely to use roadway e.g. at the end of shift, stop vehicles from using them at such times.
5. Provide high visibility clothing for people permitted in delivery area.

13.5.3 WORK VEHICLES

Work vehicles shall be as safe stable efficient and roadworthy as private vehicles on public roads. Subcontractors shall ensure that drivers are suitably trained and have valid license and experience for the designated class of vehicle. All vehicle e.g. heavy motor vehicle forklift trucks dump trucks mobile cranes shall ensure that the work equipment conforms to the following:

1. A high level of stability.
2. A safe means of access/egress.
3. Suitable and effective service and parking brakes.
4. Windscreens with wipers and external mirrors giving optimum all round visibility.
5. Provision of horn, vehicle lights, reflectors, reversing lights, reversing alarms.
6. Provision of seat belts.
7. Guards on dangerous parts.
8. Driver protection - to prevent injury from overturning and from falling objects/materials.
9. Driver protection from adverse weather.
10. No vehicle shall be parked below HT/LT power lines in conformance to Indian Electricity Act & Rules.
11. Valid Pollution Under Control certification for all vehicles



**POWER
SECTOR**

**HEALTH, SAFETY AND ENVIRONMENT PLAN
FOR
SITE OPERATIONS
(SECTION-A)**

Doc. No.: HSEP:14-
ER

Rev.: 01

Date:08.05.20

Page 83 of 170

13.5.4 DAILY CHECKS BY DRIVER

There should also be daily safety checks containing below mentioned points by the driver before the vehicle is used. Subcontractors should ensure that drivers carry out these checks as a minimum.

Brakes	Mirrors	Warning signals
Tires	Windscreen waters	Specific safety system i.e. control interlocks
Steering	Wipers	

13.5.5 TRANSPORTATION OF PERSONNEL AND MATERIALS BY VEHICLES

1. All drivers shall hold a valid driving License for the class of vehicle to be driven and be registered as an authorized BHEL driver with the Administration Department.
2. Securing of the load shall be by established and approved methods, i.e. chains with patented tightening equipment for steel/heavy loads. Sharp corners on loads shall be avoided when employing ropes for securing.
3. All overhangs shall be made clearly visible and restricted to acceptable limits
4. Load shall be checked before moving off and after traveling a suitable distance.
5. On no account is construction site to be blocked by parked vehicles Drivers of vehicles shall only stop or park in the areas designate by the stringing foreman.
6. Warning signs shall be displayed during transportation of material.
7. All vehicles used by Subcontractor shall be in worthy condition and in conformance to the Land Transport requirement

13.5.6 MAINTENANCE

All Vehicles used for transportation of man and material shall undergo scheduled inspections on frequent intervals to secure safe operation. Such inspections shall be conducted in particular for steering, brakes, lights, horn, doors etc. Site management shall ensure that work equipment is maintained in an efficient, working order and in good repair. Inspections and services carried out at regular intervals of time and or mileage. No maintenance shall be carried below HT/LT power lines.

13.6 EMERGENCY PREPAREDNESS AND RESPONSE

1. Subcontractor shall develop Emergency preparedness and response capability and Emergency Response Team as per [HSEP06: HSE Procedure for Emergency Preparedness and Response](#)
2. Availability of adequate number of first aiders and fire warden shall be ensured
3. All the subcontractor's supervisory personnel and sufficient number of workers shall be trained for fire protection systems. Enough number of such trained personnel must be available during the tenure of contract. Subcontractor should nominate his supervisor to coordinate and implement the safety measures and communicate the same to BHEL.
4. Assembly point shall be earmarked and access to the same from different location shall be shown
5. Fire exit shall be identified and pathway shall be clear for emergency escape.
6. Appropriate type and number of fire extinguisher shall be deployed as per Clause No. 13.2.11 and validity shall be ensured periodically through inspection
7. Adequate number of first aid boxes shall be strategically placed at different work places to cater



**POWER
SECTOR**

**HEALTH, SAFETY AND ENVIRONMENT PLAN
FOR
SITE OPERATIONS
(SECTION-A)**

Doc. No.: HSEP:14-
ER

Rev.: 01

Date:08.05.20

Page 84 of 170

- to all emergency needs. Holder of the first aid box shall be identified on the box itself who will have the responsibility to maintain the same.
8. First aid center shall be developed at site with trained medical personnel and ambulance
 9. Emergency contact numbers of the site shall be displayed at prominent locations.
 10. Tie up with fire brigade shall be done in case customer is not having fire station.
 11. Tie up with hospital shall be ensured in order to ensure the availability of following services to victims quickly without wasting precious time:
 - a. Intensive Care Unit with Ventilator and other necessary life support systems
 - b. Facility of specialized Orthopedic Surgery – in case of fracture / amputation
 - c. Facility of specialized brain / neuro surgery – in case of head trauma
 - d. Facility of specialized burn unit / ward – in case of Fire / burn injury
 - e. and other facilities as per requirement at site location

In case tie up with multiple hospitals is required to cover all possible accidents, same shall be done. The list of facilities to be regularly checked and updated.
 12. A detailed emergency services (Fire / Medical etc.) tie up plan shall be submitted to BHEL in monthly report Format No. HSEP:14-F05
 13. Mock drill shall be conducted on different emergencies periodically to find out gaps in emergency preparedness and taking necessary corrective action

14 HSE INSPECTION

Inspection on HSE for different activities being carried out at site shall be done to ensure compliance to HSEMS requirements. The subcontractor shall maintain necessary safety equipment as applicable, to enable inspection personnel/agency perform Inspection. If any test equipment is found not complying with proper safety requirements then the Inspection Agency may withhold inspection, till such time the desired safety requirements are met.

The requirements of respective work permits are to be ensured by respective supervisors, safety personnel and area in-charges. In addition, the formats & checklists as per Clause 21 of this document provided by BHEL shall be used for inspection by Safety personnel (as a minimum), and records of inspection to be maintained. BHEL shall reserve the right to modify any Format in this document or introduce additional checklists / formats to ensure regular inspection of all equipment as per requirement.

14.1 DAILY HSE CHECKS

Both the Site Supervisors and HSE Supervisors are to conduct daily site Safety inspection around work activities and premises to ensure that work methods and the sites are maintained to an acceptable standard. The following are to form the common subjects of a daily safety inspection:



POWER
SECTOR

HEALTH, SAFETY AND ENVIRONMENT PLAN
FOR
SITE OPERATIONS
(SECTION-A)

Doc. No.: HSEP:14-
ER
Rev.: 01
Date:08.05.20
Page 85 of 170

1. Height Work:

- a. Safe, barricaded platform
 - b. PPEs
 - c. Proper method
 - d. Awareness
2. Personal Safety wears & gear compliance.
 3. Complying with site safety rules and permit-to-work (PTW).
 4. Positions and postures of workers.
 5. Use of tools and equipment etc. by the workers.
 6. The inspection shall be carried out just when work starts in beginning of the day, during peak activities period of the day and just before the day's work ends.

14.2 INSPECTION OF HEIGHT WORKING

1. Any kind of height work (above 2 meters) shall not be carried out without active physical supervision by concerned supervisor or safety personnel. All non-conformances related to height work shall be handled on priority and closed immediately after halting the work.
2. A roster of personnel deployed for inspection of height work and other critical activities shall be prepared and submitted to BHEL in monthly report Format No. HSEP:14-F05, in order to ensure effective supervision at all times
3. Inspection on height working shall be conducted **daily** by supervisors before start of work to ensure safe working condition including provision of:

a. Fall arrestor	d. Fencing and barricading	g. Proper scaffolding with valid Tags, access and egress.
b. Lifelines	e. Warning signage	h. Illumination
c. Safety nets	f. Covering of opening	

4. Inspection on height working shall be conducted once in a week by HSE officer as per
5. Format no. HSEP: 14-F10.
6. Medical fitness, including vertigo test of height worker shall be ensured.
7. Height working shall not be allowed during adverse weather.

14.3 INSPECTION OF PPE

PPEs shall be inspected by HSE officer at random once in a week as per Format no. HSEP: 14-F06 for compliance to standard and provisions and any adverse observation shall be recorded in the PPE register.

14.4 INSPECTION OF T&Ps

1. All T& Ps being used at site shall be inspected by HSE officer once in a month as per specific Formats in this document, or (if not available) general Format no. HSEP: 14-F07 for its healthiness and maintenance.
2. A master list of T&Ps and validity of their inspection certificates shall be maintained by each agency and details shall be submitted to BHEL in monthly format no. HSEP:14-F05.
3. The T&Ps which require third party inspection shall be checked for its validity during inspection.



**POWER
SECTOR**

**HEALTH, SAFETY AND ENVIRONMENT PLAN
FOR
SITE OPERATIONS
(SECTION-A)**

Doc. No.: HSEP:14-
ER

Rev.: 01

Date:08.05.20

Page 86 of 170

The third party test certificate should be accompanied with a copy of the concerned competent person's valid qualification record. BHEL shall be given advance intimation of Third Party Inspection. BHEL shall associate with Inspection as per discretion.

14.5 INSPECTION OF CRANES AND WINCHES

1. Cranes and winches shall be inspected by the operator through a daily checklist for its safe condition (as provided by the equipment manufacturer) before first use of the day.
2. Cranes and Winches shall be inspected by HSE officer once in a month as per Format no. HSEP: 14-F08 & F09 for healthiness, maintenance and validity of third party inspection.
3. The date of third party inspection and next due date shall be painted on cranes and winches.
4. The operators/drivers shall be authorized by sub-contractor based on their competency and experience and shall carry the I-card.
5. The operator should be above 18 years of age and should be in possession of driving license of HMV man & goods), vision test certificate and should have minimum qualification so that he can read the instructions and check list.

14.6 INSPECTION ON WELDING AND GAS CUTTING OPERATION

1. Supervisor shall ensure that no flammable items are available in near vicinity during welding and gas cutting activity.
2. Gas cylinders shall be kept upright.
3. Use of Flash back arrestor shall be ensured at both ends.
4. Inspection during welding and gas cutting operations shall be carried out by HSE officer once a month as per Format no. HSEP: 14-F11.
5. Use of fire blanket to be ensured to avoid falling of splatters during welding or gas cutting operation at height.
6. Availability of fire extinguisher in vicinity shall be ensured.

14.7 INSPECTION ON ELECTRICAL INSTALLATION / APPLIANCES

1. Ensure proper earthing in electrical installation
2. Use of ELCB at electrical booth
3. Electrical installation shall be properly covered at top where required
4. Use appropriate PPEs while working
5. Use portable electrical light < 24 V in confined space and potentially wet area.
6. Monthly inspection shall be carried out as per Format no. HSEP: 14-F12.

14.8 INSPECTION OF ELEVATOR

1. Elevators shall be inspected by concerned supervisors once in a week as per Format no. HSEP: 14-F13.
2. All elevators shall be inspected by competent person and validity shall be ensured.
3. The date of third party inspection and next due date shall be painted on elevator.



**POWER
SECTOR**

**HEALTH, SAFETY AND ENVIRONMENT PLAN
FOR
SITE OPERATIONS
(SECTION-A)**

Doc. No.: HSEP:14-
ER

Rev.: 01

Date:08.05.20

Page 87 of 170

14.9 MONTHLY SITE INSPECTION

Subcontractor shall carry out monthly HSE inspection of all work areas as per Format No. HSEP:14-F20 and submit to BHEL

14.10 NON-CONFORMITY HANDLING:

Any serious non-conformances identified during inspection observed shall be addressed immediately.

In case immediate closure of non-conformities is not possible:

- a. work to be halted in the area
- b. Non-conformance to be generated and submitted to responsible person and BHEL
- c. non-conformance to be resolved through responsible agency / person
Only after closure of serious non-conformances, work to be allowed to resume.

All non-conformances & safety violations to be recorded and closed in a time bound manner.

15 HSE PERFORMANCE

HSE performance of subcontractor shall be monitored as per BHEL criteria, based on which, marks will be awarded. Marks can be used to evaluate and rate the contractor as per BHEL internal systems. Format for vendor HSE performance evaluation is attached in annexure (Format No. HSEP:14-F33)

Subcontractor shall make available all data required for evaluation to BHEL as and when demanded.

1. If safety record of the subcontractor in execution of the awarded job is to the satisfaction of safety department of BHEL, issue of an appropriate certificate to recognize the safety performance of the subcontractor may be considered by BHEL after completion of the job.
2. 1.5% of running bill shall be cleared subject to certification of desired safety performance by BHEL

16 HSE PENALTIES FOR NON-COMPLIANCE

1. Nonconformity of safety rules and safety appliances will be viewed seriously and BHEL has right to impose fines on the subcontractor for every instance of violation noticed.
2. The applicable penalties for HSE violations are given in Format No. HSEP14-F14 of this document



POWER
SECTOR

HEALTH, SAFETY AND ENVIRONMENT PLAN
FOR
SITE OPERATIONS
(SECTION-A)

Doc. No.: HSEP:14-
ER

Rev.: 01

Date:08.05.20

Page 88 of 170

3. The list of non-compliances given in above format is not exhaustive. The BHEL site in-charge has liberty to impose a penalty for any other non-compliance and incidents of any nature.
4. If principal customer or statutory and regulatory bodies impose penalty on ground of statutory non-compliance or non-compliance of HSE rules by the subcontractor or any incident of any nature including fatality or permanent disability, the same shall be passed on to the subcontractor with appropriate overhead
5. The penalty amount shall be recovered from subcontractors from the RA Bill, otherwise Final bill.

17 COMPENSATION TO ACCIDENT VICTIMS

1. BHEL shall recover the amount of compensation paid to victim(s) by BHEL towards loss of life / permanent disability due to an accident which is attributable to the negligence of contractor, agency or firm or any of its employees as detailed below.
 - b. **Victim:** Any person who suffers permanent disablement or dies in an accident as defined below.
 - c. **Accident:** Any death or permanent disability resulting solely and directly from any unintended and unforeseen injurious occurrence caused during the manufacturing/ operation and works incidental thereto at BHEL factories/ offices and precincts thereof, project execution, erection and commissioning, services, repairs and maintenance, trouble shooting, serving, overhaul, renovation and retrofitting, trial operation, performance guarantee testing undertaken by the company or during any works / during working at BHEL Units/ Offices/ townships and premises! Project Sites.
 - d. **Compensation in respect of each of the victims:**
 - i. In the event of death or permanent disability resulting from Loss of both limbs: Rs. 10,00,000/- (Rs. Ten Lakh)
 - ii. (ii) In the event of other permanent disability: Rs. 7,00,000/- (Rs. Seven Lakh)
 - e. **Permanent Disability:** A disablement that is classified as a permanent total disablement under the proviso to Section 2 (I) of the Employee's Compensation Act, 1923. "
2. In addition to above, contractor shall provide appropriate compensation to victims of major and fatal incidents as per Employee Compensation Act, 1923, ESIC Act, 1948 or as per any existing Acts and guidelines



**POWER
SECTOR**

**HEALTH, SAFETY AND ENVIRONMENT PLAN
FOR
SITE OPERATIONS
(SECTION-A)**

Doc. No.: HSEP:14-
ER

Rev.: 01

Date:08.05.20

Page 89 of 170

18 INTERNAL & EXTERNAL HSE AUDITS

1. Subcontractor shall extend full co-operation and maintain necessary documents & records as required by Internal & External HSE Audit carried out by BHEL. / Third Party
2. All non-conformities and observations on HSE shall be disposed of-by subcontractor in a time bound manner as detailed in Audit Report.
3. All required corrective actions shall be taken by the subcontractor in order to avoid recurrence

19 OTHER REQUIREMENTS

1. In case of any delay in completion of a job due to mishaps attributable to lapses by the subcontractor, BHEL shall have the right to recover cost of such delay from the payments due to the subcontractor, after holding an appropriate enquiry and notifying the subcontractor suitably.
2. **RISK & COST:**

If the subcontractor fails to improve the standards of safety in its operation to the satisfaction of BHEL after being given reasonable opportunity to do so and/or if the subcontractor fails to take appropriate safety precautions or to provide necessary safety devices and equipment or to carry out instruction regarding safety as per contractual requirements, BHEL shall have the right to take corrective steps at the risk and cost of the subcontractor after giving a notice of not less than 7 days indicating the steps that would be taken by BHEL.
3. If the subcontractor succeeds in carrying out its job in time without any fatal or disabling injury incident and without any damage to property BHEL may, at its sole discretion, favourably consider to reward the subcontractor suitably for the performance.
4. The subcontractor shall take all measures at all the sites of work to protect all persons from incidents and shall be bound to bear the expenses of every suit, action or other proceeding of law that may be brought by any persons for injury sustained, death or damage to environment



**POWER
SECTOR**

**HEALTH, SAFETY AND ENVIRONMENT PLAN
FOR
SITE OPERATIONS
(SECTION-A)**

Doc. No.: HSEP:14-
ER

Rev.: 01

Date:08.05.20

Page 90 of 170

owing to neglect of the HSE precautions by the subcontractor; and shall be liable to pay any such persons such compensation, should such claim proceeding be filed against BHEL.

The subcontractor hereby agrees to indemnify BHEL against the same.

20 HSE REVIEW

BHEL shall hold HSE review meeting every month or as per requirement in order to discuss and resolve HSE issues of site and improve HSE performance. It will also discuss the incidents occurred since previous meeting, its root cause and Corrective action. The indicative agenda is given below:

1. Implementation of earlier MOM
2. HSE performance review
3. HSE inspection review w.r.t non-conformances observed and their status
4. HSE audit and CAPA
5. HSE training conducted and requirement
6. Health check-up camp
7. HSE planning for the erection and commissioning and installation activities in the coming month
8. HSE reward and promotional activities
9. HSE data analysis and improvement – Data analyzed will include non-conformances closed and pending, incident data, training data etc.

Subcontractor shall ensure presence of site in-charge, all package in-charges and safety officers, as communicated by BHEL in the meeting.

Subcontractor shall take requisite actions as per record notes and as decided in the meeting, in a time bound manner and submit compliance report to BHEL.

 POWER SECTOR	HEALTH, SAFETY AND ENVIRONMENT PLAN FOR SITE OPERATIONS (SECTION-A)	Doc. No.: HSEP:14-ER
		Rev.: 01
		Date:08.05.20
		Page 91 of 170

21 FORMATS USED

This is minimum list of Formats to be used for reporting by the subcontractor. Other Formats are indicated in respective HSE Procedures, Work Permits, OCPs or as specified by BHEL. The medium of reporting can be hard / soft as indicated by BHEL.

BHEL can modify these Formats or introduce new Formats to the extent necessary to get the desired performance data of all HSE activities.

SN	Format Name	Format No.	Frequency of check	Rev
1	Work at Height Permit	HSEP:14-FP01	Before start of work and regularly thereafter as per Permit conditions	00
2	Hot Work Permit	HSEP:14-FP02		00
3	Confined Space Work Permit	HSEP:14-FP03		00
4	Excavation Work Permit	HSEP:14-FP04		00
5	Radiation Work Permit	HSEP:14-FP05		00
6	Lifting Activity Work Permit	HSEP:14-FP06		00
7	Lockout-Tagout Work Permit	HSEP:14-FP07		00
8	Inspection of First Aid Box	HSEP:14-F01	Weekly	00
9	Health Check Up	HSEP:14-F02	With new Induction & as per requirement thereafter	00
10	HSE Induction / Regular / On-the-Job Training	HSEP:14-F03	With new Induction & as per requirement thereafter	00
11	Tool Box Talk	HSEP:14-F04	Daily before job start	00
12	Site HSE Report	HSEP:14-F05	Monthly	00
13	PPE Inspection	HSEP:14-F06	Weekly	00
14	PPE Issue and Receipt	HSEP:14-F06A	With new Induction	
15	Inspection of T&Ps (General)	HSEP:14-F07	Monthly / As per requirement	00
16	Inspection of Cranes	HSEP:14-F08	Monthly / As per requirement	00
17	Inspection of Winches	HSEP:14-F09	Monthly / As per requirement	00
18	Inspection of Height Working	HSEP:14-F10	Daily / As per requirement	00
19	Inspection on Welding & Gas Cutting	HSEP:14-F11	Weekly / As per requirement	00
20	Inspection on Electrical Installation	HSEP:14-F12	Weekly / As per requirement	00
21	Inspection on Elevator	HSEP:14-F13	Weekly / As per requirement	00
22	HSE Penalty	HSEP:14-F14	-	00
23	Initial Verification of PPE's & Lifting Tools & Tackles	HSEP:14-F15	As and when new PPEs and T&Ps are received	00
24	Inspection of Labor Colony	HSEP:14-F16	Monthly / as per requirement	00
25	Recording of First Aid Injuries	HSEP:14-F17	As and when such injuries occur	00
26	E-waste Handled / Generated	HSEP:14-F18	Half Yearly	00
27	Hazardous Waste at the Facility	HSEP:14-F19	Half Yearly	00
28	HSE Checklist-cum-Compliance Report	HSEP:14-F20	As per Audit Calendar	00
29	Illumination Levels	HSEP:14-F21	Weekly / As per requirement	00
30	Incident Reporting	HSEP:14-F22	-	00
31	Incident Recording	HSEP:14-F23	-	00
32	Monthly HSE Planning & Review	HSEP:14-F30	Monthly	00
33	Daily HSE Reporting	HSEP:14-F31A	Daily	00
34	Job Safety Analysis	HSEP:14-F32B	Before starting new job	00
35	Evaluation of HSE Performance	HSEP:14-F33	Monthly	00



HSEP:14-FP01

WORK AT HEIGHT PERMIT	Permit No. & Date
Project & Unit:	Emergency Contact Nos:
BHEL Sub-contractor:	

Exact Location of Work: _____

Nature / Description of Work: _____

Duration of Work Execution *: From Date: _____ to Date: _____ Daily from _____ hrs. to _____ hrs.

Name of Sub-Contractor Performing the Work: _____

Name of Sub-Contractor's Site Engineer (Permit Requesting Authority): _____ Sign: _____

Name of Sub-Contractor's Package In-charge: _____ Sign: _____ Date: _____

The above described work will be done under all the safety precautions mentioned as under during the currency of the Permit.

No.	Item	Yes	Not required / Remarks
1	All workers on job are competent and medically fit (No Height Phobia) for working at height		
2	Hazards in the vicinity are identified, controlled and communicated to the worker.		
3	Scaffolding soundness inspected is available for use with valid tag		
4	Work platform is not made of bamboo or weak material. Barricading is available with Top, Mid Rails and Toe Guard.		
5	Working platform is clean without any unwanted material. Floor openings are covered.		
6	Access and exit to workplace are safe, marked and without obstruction.		
7	Adequate lighting provided (for dark hours) as per applicable lux standards (Refer HSEP:13)		
8	Safety nets are provided below working area.		
9	Area below the working platform has been cleared of all activity		
10	Ladders have been secured, inspected and provided as per BHEL standard/contract.		
11	Horizontal life lines are provided to cater to design specification of 2300 kg per person.		
12	Safety harness with life line support/ fall arrester are checked and available in working condition		
13	Safety shoes (non-slip), Helmet with chin strip available with employees		
14	Visible Signboards provided on working platforms in workers' understandable language		
15	All lifting / tightening tools, hand tools/equipment checked and in good condition		
16	ELCB provided for Electrical connections individually. Electrical cable, welding Hose/Compressed air hose properly secured and laid down without obstruction. Earth resistance is OK.		
17	Crane / Winch / Hydra operator is qualified and experienced		
18	Emergency response team & Medical Facilities available. Work area is cordoned off.		
19	Job Safety Analysis Submitted		
20	Additional Permits to be taken (Please specify & attach):		

Declaration: All the points mentioned in the above checklist have been checked and found OK**Permit Receiver:**

Site Engineer (Sub- Contractor):	Site Safety Officer (Sub-Contractor):
Signature:	Signature:
Name: Designation:	Name: Designation:

Permit Issuer:

Engineer of Concerned Execution Department (BHEL):	Site Safety Officer (BHEL):
Signature:	Signature:
Name: Designation:	Name: Designation:

Package-in-charge (BHEL):
Signature:
Name: Designation:

Verified by Customer Representative (if applicable), Name: _____ Sign: _____ Date: _____ Time: _____

(* Permit valid for 7 days, subject to daily renewal, and extension as per overleaf instructions / record formats)

Work at Height Permit No. & Date:

Daily Work Area Condition Endorsement

Sl. No.	Date	Signature with Date & Time		Remarks
		Agency Safety	BHEL Safety	
Day 2				
Day 3				
Day 4				
Day 5				
Day 6				
Day 7				

Permit Extension Beyond Initially Requested Hours

Sl. No.	Extension Period		Remarks	Signature with Date & Time			
	From..... (Date & Time)	To..... (Date & Time)		Agency Site Engineer	Agency Safety Officer	BHEL Site Engineer (PIA)	BHEL Safety Officer
1.							
2.							
3.							
4.							
5.							
6.							

TO BE SIGNED BY THE BHEL HSE & EXECUTION AFTER THE WORK IS OVER

Permit is here by returned after completing the job & ensuring safe removal of men and material.

Site Engineer, BHEL		Site HSE Engineer, BHEL	
Signature:		Signature:	
Name:		Name:	

General Instructions:

1	This Permit is required for working at height of 2 mtr. and above or above excavation of 2 mtr or deeper.
2	This permit must be available at the work site all the times of the work.
3	Location and description of the work must be clearly indicated by the permittee.
4	Terms applicable must be clearly indicated by the permittee.
5	This permit shall be endorsed each day only after checking all the compliance jointly by the contractor and BHEL safety.
6	Permit shall be issued for not more than 7 days including the issue date.
7	Permit shall be returned to the HSE Department of BHEL after completion of the job.
8	Before engaging anybody to work at height, height phobia needs to be ascertained and proper fitness certificate to be ensured.
9	All safety precautions to be taken as per work site HSE plan.
10	Distribution of copy:
	Original- Permittee, Duplicate –Department HOS, Contractor, Triplicate - Site HSE Dept.,



HSEP:14-FP02

HOT WORK PERMIT

Permit No. & Date

Project & Unit:

Emergency Contact Nos:

BHEL Sub-contractor:

Exact Location of Work: _____

Nature / Description of Work: _____

Duration of Work Execution *: From Date: _____ to Date: _____ Daily from _____ hrs. to _____ hrs.

Name of Sub-Contractor Performing the Work: _____

Name of Sub-Contractor's Site Engineer (Permit Requesting Authority): _____ Sign: _____

Name of Sub-Contractor's Package In-charge: _____ Sign: _____ Date: _____

The above described work will be done under all the safety precautions mentioned as under during the currency of the Permit.

No.	Item	Yes	Not required / Remarks
1.	Welder is trained and qualified with good attendance in on-the-job training		
2.	Area ensured safe and free from all hazards (explosives etc.) with barricading and safe inlet / exit		
3.	Proper ventilation and lighting provided (in case of dark hours).		
4.	Gas hoses are in good condition and not cut / leaking		
5.	Pressure gauges/Flash back arrestor (at both ends) provided and in working condition.		
6.	Gas pressure in cylinder is within limits and hydraulic test certificate is available		
7.	Gas cylinders are stacked vertically and not below the welding / cutting area. Regulator key is available with cylinder. Gas cylinders covered with shields to prevent falling splinters.		
8.	Power supply to welding machine is through ELCB of 30 mA rating, which is tested and found ok; Earthing is tested and found OK		
9.	Welding machine input/output cables, welding holder and weld return clamp (Holder) are insulated and in good condition.		
10.	In case of welding in enclosed / confined spaces, the integrity of the structure and supports are ensured, Gas Testing done and evacuation system ensured in place		
11.	Emergency STOP buttons are in working condition. Welder /Helper knows how to operate it.		
12.	Welder & Fitter trained to connect ground/work return clamps (Holder) to work place prior to energization of welding machine.		
13.	Personal Protective equipment Minimum applicable: safety helmet, safety goggles, welding helmet, safety (rubber) shoes, leather gloves, long sleeve and nose mask -provided		
14.	In case of pits, water removed from the pit and wood/rubber insulation provided.		
15.	Safety signboards / cautions are in place.		
16.	Adequate and Suitable nos. of applicable firefighting extinguisher provided.		
17.	Nearby combustible material removed. Housekeeping done.		
18.	All workers explained about the hazards		
19.	First aid in attendance.		
20.	Any other Precautions or Permits required (Height Work, Confined Space etc.), give details and attach		

Declaration: All the points mentioned in the above checklist have been checked and found OK**Permit Receiver:**

Site Engineer (Sub- Contractor):	
Signature:	
Name:	Designation:

Site Safety Officer (Sub-Contractor):	
Signature:	
Name:	Designation:

Permit Issuer:

Engineer of Concerned Execution Department (BHEL):	
Signature:	
Name:	Designation:

Site Safety Officer (BHEL):	
Signature:	
Name:	Designation:

Package-in-charge (BHEL):	
Signature:	
Name:	Designation:

Verified by Customer Representative (if applicable), Name: _____ Sign: _____ Date: _____ Time: _____

(* Permit valid for 7 days, subject to daily renewal, and extension as per overleaf instructions / record formats)

Hot Work Permit No. & Date:
_____**Daily Work Area Condition Endorsement**

Sl. No.	Date	Signature with Date & Time		Remarks
		Agency Safety	BHEL Safety	
Day 2				
Day 3				
Day 4				
Day 5				
Day 6				
Day 7				

Permit Extension Beyond Initially Requested Hours

Sl. No.	Extension Period		Remarks	Signature with Date & Time			
	From..... (Date & Time)	To..... (Date & Time)		Agency Site Engineer	Agency Safety Officer	BHEL Site Engineer (PIA)	BHEL Safety Officer
1.							
2.							
3.							
4.							
5.							
6.							

TO BE SIGNED BY THE BHEL HSE & EXECUTION AFTER THE WORK IS OVER

Permit is here by returned after completing the job & ensuring safe removal of men and material.

Site Engineer, BHEL		Site HSE Engineer, BHEL	
Signature:		Signature:	
Name:		Name:	

General Instructions:

1	This Permit is required for all kinds of Hot Work eg. Welding, cutting etc..
2	This permit must be available at the work site all the times of the work.
3	Location and description of the work must be clearly indicated by the permittee.
4	Terms applicable must be clearly indicated by the permittee.
5	This permit shall be endorsed each day only after checking all the compliance jointly by the contractor and BHEL safety.
6	Permit shall be issued for not more than 7 days including the issue date.
7	Permit shall be returned to the HSE Department of BHEL after completion of the job.
8	Before engaging anybody to work, competency and fitness to be ensured.
9	All safety precautions to be taken as per work site HSE plan.
10	Distribution of copy:
	Original- Permittee, Duplicate –Department HOS, Contractor, Triplicate - Site HSE Dept.,



HSEP:14-FP03

CONFINED SPACE WORK PERMIT	Permit No. & Date
Project & Unit:	Emergency Contact Nos:
BHEL Sub-contractor:	

Exact Location of Work: _____

Nature / Description of Work: _____

Duration of Work Execution *: From Date: _____ to Date: _____ Daily from _____ hrs. to _____ hrs.

Name of Sub-Contractor Performing the Work: _____

Name of Sub-Contractor's Site Engineer (Permit Requesting Authority): _____ Sign: _____

Name of Sub-Contractor's Package In-charge: _____ Sign: _____ Date: _____

The above described work will be done under all the safety precautions mentioned as under during the currency of the Permit.

No.	Item	Yes	Not required / Remarks
1.	Has the equipment been Isolated from Power/Steam/Air?		
2.	Has the equipment been Isolated from liquid or gases?		
3.	Has the equipment been de-pressurized &/or drained?		
4.	Has the equipment been Blanked/blinded or disconnected?		
5.	Has the equipment been water flushed &/or steamed?		
6.	Whether man ways open and ventilated?		
7.	Whether constant Inert gas flow arranged?		
8.	Whether mechanically ventilated and adequately cooled?		
9.	Whether 24 V lighting provided inside the confined space?		
10.	Whether Radiation sources removed?		
11.	Whether training on confined space provided to the individual / group?		
12.	Whether required PPEs (hand gloves, goggles, face shield, ear plug/muff, protective clothing etc.) used?		
13.	Whether Safety harness and Lifeline used?		
14.	Whether Dust/Gas/Air Line mask used?		
15.	Whether attendant with SCBA/Air mask available?		
16.	Whether grounded air Exhaust/Blower/ AC provided?		
17.	Whether Personal Gas alarm provided?		
18.	Whether communication Equipment Provided?		
19.	Whether rescue equipment/team available?		
20.	Whether firefighting arrangement done		
21.	Any other Precautions or Permits required (Height Work, Confined Space etc.), give details and attach		

Declaration: All the points mentioned in the above checklist have been checked and found OK**Permit Receiver:**

Site Engineer (Sub- Contractor):
Signature:
Name: _____ Designation: _____

Site Safety Officer (Sub-Contractor):
Signature:
Name: _____ Designation: _____

Permit Issuer:

Engineer of Concerned Execution Department (BHEL):
Signature:
Name: _____ Designation: _____

Site Safety Officer (BHEL):
Signature:
Name: _____ Designation: _____

Package-in-charge (BHEL):
Signature:
Name: _____ Designation: _____

 Verified by Customer Representative (if applicable), Name: _____ Sign: _____ Date: _____ Time: _____

(* Permit valid for 7 days, subject to daily renewal, and extension as per overleaf instructions / record formats)

Confined Space Work Permit No. & Date:
_____**Daily Work Area Condition Endorsement**

Sl. No.	Date	Signature with Date & Time		Remarks
		Agency Safety	BHEL Safety	
Day 2				
Day 3				
Day 4				
Day 5				
Day 6				
Day 7				

Permit Extension Beyond Initially Requested Hours

Sl. No.	Extension Period		Remarks	Signature with Date & Time			
	From..... (Date & Time)	To..... (Date & Time)		Agency Site Engineer	Agency Safety Officer	BHEL Site Engineer (PIA)	BHEL Safety Officer
1.							
2.							
3.							
4.							
5.							
6.							

TO BE SIGNED BY THE BHEL HSE & EXECUTION AFTER THE WORK IS OVER

Permit is here by returned after completing the job & ensuring safe removal of men and material.

Site Engineer, BHEL		Site HSE Engineer, BHEL	
Signature:		Signature:	
Name:		Name:	

General Instructions:

1	This Permit is required for all confined space tasks, where injury can happen due to lack of oxygen, or chances of fire are there due to gas accumulation.
2	This permit must be available at the work site all the times of the work.
3	Location and description of the work must be clearly indicated by the permittee.
4	Terms applicable must be clearly indicated by the permittee.
5	This permit shall be endorsed each day after checking all the compliance jointly by the contractor and BHEL safety.
6	Permit shall be issued for not more than 7 days including the issue date.
7	Permit shall be returned to the HSE Department of BHEL after completion of the job.
8	Before engaging anybody to work, competency and fitness to be ensured.
9	All safety precautions to be taken as per work site HSE plan.
10	Distribution of copy:
	Original- Permittee, Duplicate –Department HOS, Contractor, Triplicate - Site HSE Dept.,



HSEP:14-FP04

EXCAVATION WORK PERMIT	Permit No. & Date
Project & Unit:	Emergency Contact Nos:
BHEL Sub-contractor:	

Exact Location of Work: _____

Nature / Description of Work: _____

Duration of Work Execution *: From Date: _____ to Date: _____ Daily from _____ hrs. to _____ hrs.

Name of Sub-Contractor Performing the Work: _____

Name of Sub-Contractor's Site Engineer (Permit Requesting Authority): _____ Sign: _____

Name of Sub-Contractor's Package In-charge: _____ Sign: _____ Date: _____

The above described work will be done under all the safety precautions mentioned as under during the currency of the Permit.

No.	Item	Yes	Not required / Remarks
1	Precautions taken for Underground Electrical Cable		
2	Precautions taken for Under / Above ground sewer/Drinking Water Line		
3	Precautions taken for Underground Telecommunication Line		
4	Precautions taken for Underground Product/Utility Line		
5	Precautions taken for Underground Fire Water Line		
6	Shoring / Shuttering / Sheet piling done to prevent collapse of excavation walls. Strength of Excavation wall ensured at all times		
7	Hard Barricading & Edge Protection provided		
8	Separate Safe Access for Man and Vehicle		
9	Lighting arrangement		
10	Banks Man Provided		
11	Required basic PPEs provided		
12	Slope Cutting/Benching Maintained		
13	Excavated soil / Construction Material / equipment kept away from the edge.		
14	First aid in attendance.		
15	Any other Precautions or Permits required (Height Work, Confined Space etc.), give details and attach		

Declaration: All the points mentioned in the above checklist have been checked and found OK**Permit Receiver:**

Site Engineer (Sub- Contractor):	
Signature:	
Name:	Designation:

Site Safety Officer (Sub-Contractor):	
Signature:	
Name:	Designation:

Permit Issuer:

Engineer of Concerned Execution Department (BHEL):	
Signature:	
Name:	Designation:

Site Safety Officer (BHEL):	
Signature:	
Name:	Designation:

Package-in-charge (BHEL):	
Signature:	
Name:	Designation:

Verified by Customer Representative (if applicable), Name: _____ Sign: _____ Date: _____ Time: _____

(* Permit valid for 7 days, subject to daily renewal, and extension as per overleaf instructions / record formats)

Excavation Work Permit No. & Date:
_____**Daily Work Area Condition Endorsement**

Sl. No.	Date	Signature with Date & Time		Remarks
		Agency Safety	BHEL Safety	
Day 2				
Day 3				
Day 4				
Day 5				
Day 6				
Day 7				

Permit Extension Beyond Initially Requested Hours

Sl. No.	Extension Period		Remarks	Signature with Date & Time			
	From..... (Date & Time)	To..... (Date & Time)		Agency Site Engineer	Agency Safety Officer	BHEL Site Engineer (PIA)	BHEL Safety Officer
1.							
2.							
3.							
4.							
5.							
6							

TO BE SIGNED BY THE BHEL HSE & EXECUTION AFTER THE WORK IS OVER

Permit is here by returned after completing the job & ensuring safe removal of men and material.

Site Engineer, BHEL		Site HSE Engineer, BHEL	
Signature:		Signature:	
Name:		Name:	

General Instructions:

1	This Permit is required for all excavation tasks 1.22 mtr or deeper
2	This permit must be available at the work site all the times of the work.
3	Location and description of the work must be clearly indicated by the permittee.
4	Terms applicable must be clearly indicated by the permittee.
5	This permit shall be endorsed each day after checking all the compliance jointly by the contractor and BHEL safety.
6	Permit shall be issued for not more than 7 days including the issue date.
7	Permit shall be returned to the HSE Department of BHEL after completion of the job.
8	Before engaging anybody to work, competency and fitness to be ensured.
9	All safety precautions to be taken as per work site HSE plan.
10	Distribution of copy:
	Original- Permittee, Duplicate –Department HOS, Contractor, Triplicate - Site HSE Dept.,



HSEP:14-FP05

RADIATION WORK PERMIT		Permit No. & Date
Project & Unit:		Emergency Contact Nos:
BHEL Sub-contractor:		

Exact Location of Work: _____

Nature / Description of Work: _____

Duration of Work Execution *: From Date: _____ to Date: _____ Daily from _____ hrs. to _____ hrs.

Name of Sub-Contractor Performing the Work: _____

Name of Sub-Contractor's Site Engineer (Permit Requesting Authority): _____ Sign: _____

Name of Sub-Contractor's Package In-charge: _____ Sign: _____ Date: _____

The above described work will be done under all the safety precautions mentioned as under during the currency of the Permit.

No.	Item	Yes	Not required / Remarks
1.	All the persons at the site informed/removed from the area.		
2.	Area around the source of radiation cordoned off with the rope/chord.		
3.	Radiation warning symbol/boards displayed around radiography work on rope/chord.		
4.	Radiographer worn radiation badges during testing and is within safe limits.		
5.	Radiography camera and carrying case box having radiation symbol.		
6.	Radiation Survey Meter is in working condition, calibrated & within validity period.		
7.	Radiographer has valid certificate from BARC.		
8.	Blinking light provided on road during radiography (in dark hours).		
9.	Proper required Illumination provided		
10.	Safe access and working platform provided to conduct RT work		
11.	All the persons involved in Radiography work are aware of the hazard of radiation		
12.	Any other Precautions or Permits required (Height Work, Confined Space etc.), give details and attach		

Declaration: All the points mentioned in the above checklist have been checked and found OK

Permit Receiver:

Site Engineer (Sub- Contractor):	
Signature:	
Name:	Designation:

Site Safety Officer (Sub-Contractor):	
Signature:	
Name:	Designation:

Permit Issuer:

Engineer of Concerned Execution Department (BHEL):	
Signature:	
Name:	Designation:

Site Safety Officer (BHEL):	
Signature:	
Name:	Designation:

Package-in-charge (BHEL):	
Signature:	
Name:	Designation:

Verified by Customer Representative (if applicable), Name: _____ Sign: _____ Date: _____ Time: _____

(* Permit valid for 7 days, subject to daily renewal, and extension as per overleaf instructions / record formats)

Radiation Work Permit No. & Date:
_____**Daily Work Area Condition Endorsement**

Sl. No.	Date	Signature with Date & Time		Remarks
		Agency Safety	BHEL Safety	
Day 2				
Day 3				
Day 4				
Day 5				
Day 6				
Day 7				

Permit Extension Beyond Initially Requested Hours

Sl. No.	Extension Period		Remarks	Signature with Date & Time			
	From..... (Date & Time)	To..... (Date & Time)		Agency Site Engineer	Agency Safety Officer	BHEL Site Engineer (PIA)	BHEL Safety Officer
1.							
2.							
3.							
4.							
5.							
6.							

TO BE SIGNED BY THE BHEL HSE & EXECUTION AFTER THE WORK IS OVER

Permit is here by returned after completing the job & ensuring safe removal of men and material.

Site Engineer, BHEL		Site HSE Engineer, BHEL	
Signature:		Signature:	
Name:		Name:	

General Instructions:

1	This Permit is required for all activities in which there is danger of exposure to harmful radiation
2	This permit must be available at the work site all the times of the work.
3	Location and description of the work must be clearly indicated by the permittee.
4	Terms applicable must be clearly indicated by the permittee.
5	This permit shall be endorsed each day after checking all the compliance jointly by the contractor and BHEL safety.
6	Permit shall be issued for not more than 7 days including the issue date.
7	Permit shall be returned to the HSE Department of BHEL after completion of the job.
8	Before engaging anybody to work, competency and fitness to be ensured.
9	All safety precautions to be taken as per work site HSE plan.
10	Distribution of copy:
	Original- Permittee, Duplicate –Department HOS, Contractor, Triplicate - Site HSE Dept.,



HSEP:14-FP06

LIFTING ACTIVITY WORK PERMIT	Permit No. & Date
Project & Unit:	Emergency Contact Nos:
BHEL Sub-contractor:	

Exact Location of Work: _____

Nature / Description of Work: _____

Duration of Work Execution *: From Date: _____ to Date: _____ Daily from _____ hrs. to _____ hrs.

Name of Sub-Contractor Performing the Work: _____

Name of Sub-Contractor's Site Engineer (Permit Requesting Authority): _____ Sign: _____

Name of Sub-Contractor's Package In-charge: _____ Sign: _____ Date: _____

The above described work will be done under all the safety precautions mentioned as under during the currency of the Permit.

No.	Item	Yes	Not required / Remarks
1.	Crane used for lifting activity TPI tested, certified and approved for rated lifting		
2.	All lifting tackles, gears/appliances are tested and certified for lifting works.		
3.	Crane operator is trained and competent for lifting operation.		
4.	Lifting sling/ belt is protected against sharp edge of the jobs to be lifted.		
5.	Lifting hook is properly latched to prevent material falling over		
6.	Access and exit marked and without obstruction.		
7.	In case of lifting multiple materials at once, same are tied up with strong rope / material		
8.	Area below lifting activity barricaded to prevent movement		
9.	Minimum 2 guidelines have been provided for balancing and guiding jobs to be lifted.		
10.	Periphery area of crane booms as well as lifting job is barricaded and unauthorized/no-entry sign board posted.		
11.	Rigger and signal man is trained and competent for lifting work. Signal is clearly visible to the operator and understood		
12.	No lifting activity to be carried out during lightening, heavy wind/rain. No forecast of these conditions during work period		
13.	If scaffolding to be used during lift, scaffolding with valid tag available for use.		
14.	Add drawing /procedure etc. relevant for the lifting.		
15.	Any other Precautions or Permits required (Height Work, Confined Space etc.), give details and attach		

Declaration: All the points mentioned in the above checklist have been checked and found OK**Permit Receiver:**

Site Engineer (Sub- Contractor):	Site Safety Officer (Sub-Contractor):
Signature:	Signature:
Name: Designation:	Name: Designation:

Permit Issuer:

Engineer of Concerned Execution Department (BHEL):	Site Safety Officer (BHEL):
Signature:	Signature:
Name: Designation:	Name: Designation:
Package-in-charge (BHEL):	
Signature:	
Name: Designation:	

Verified by Customer Representative (if applicable), Name: _____ Sign: _____ Date: _____ Time: _____

(* Permit valid for 7 days, subject to daily renewal, and extension as per overleaf instructions / record formats)

Lifting Activity Work Permit No. & Date:
_____**Daily Work Area Condition Endorsement**

Sl. No.	Date	Signature with Date & Time		Remarks
		Agency Safety	BHEL Safety	
Day 2				
Day 3				
Day 4				
Day 5				
Day 6				
Day 7				

Permit Extension Beyond Initially Requested Hours

Sl. No.	Extension Period		Remarks	Signature with Date & Time			
	From..... (Date & Time)	To..... (Date & Time)		Agency Site Engineer	Agency Safety Officer	BHEL Site Engineer (PIA)	BHEL Safety Officer
1.							
2.							
3.							
4.							
5.							
6.							

TO BE SIGNED BY THE BHEL HSE & EXECUTION AFTER THE WORK IS OVER

Permit is here by returned after completing the job & ensuring safe removal of men and material.

Site Engineer, BHEL**Site HSE Engineer, BHEL**

Signature:

Signature:

Name:

Name:

General Instructions:

1	This Permit is required for all Heavy Lifting Activities that are either / all of the following: 1. Above 50 Tons; 2. Tandem Lifting; 3. Total Load exceeding 75%of capacity of crane; 4. Lift of unusual difficulty or geometry or rigging; 5. Lift over operating Units; 6. Any other Lift as decided by Site HSE / Erection
2	Job Safety Analysis (JSA) to be created for every Lift above 5 Tons.
3	This permit must be available at the work site all the times of the work.
4	Location and description of the work, and terms applicable must be clearly indicated by the permittee.
5	This permit shall be endorsed each day after checking all the compliance jointly by the contractor and BHEL safety.
6	Permit shall be issued for not more than 7 days including the issue date.
7	Permit shall be returned to the HSE Department of BHEL after completion of the job.
8	Before engaging anybody to work, competency and fitness to be ensured.
9	All safety precautions to be taken as per work site HSE plan.
10	Distribution of copy: Original- Permittee, Duplicate –Department HOS, Contractor, Triplicate - Site HSE Dept.



HSEP:14-FP07

LOCKOUT/TAGOUT (LIVE ELECTRICAL MAINTENANCE) WORK PERMIT

Permit No. & Date

Project & Unit:

Emergency Contact Nos:

Exact Location of Work: _____

Nature / Description of Work: _____

Duration of Work Execution *: From Date: _____ to Date: _____ Daily from _____ hrs. to _____ hrs.

Name of Sub-Contractor Performing the Work: _____

Name of Sub-Contractor's Site Engineer (Permit Requesting Authority): _____ Sign: _____

Name of Sub-Contractor's Package In-charge: _____ Sign: _____ Date: _____

The above described work will be done under all the safety precautions mentioned as under during the currency of the Permit.

Tag No.	Device to be Tagged / Locked I.D. No.	Device Location	Device Position OPEN / CLOSED - ON/OFF	Lock No.	Tag Lock		Tag / Lock	
					Placed by Name/Sign - Date/Time	Removed by Name/Sign - Date/Time		

Declaration: All the points mentioned in the above checklist have been checked and found OK

Permit Receiver:

Site Engineer (Sub- Contractor):
Signature:
Name: _____ Designation: _____

Site Safety Officer (Sub-Contractor):
Signature:
Name: _____ Designation: _____

Permit Issuer:

Engineer of Concerned Execution Department (BHEL):
Signature:
Name: _____ Designation: _____

Site Safety Officer (BHEL):
Signature:
Name: _____ Designation: _____

Package-in-charge (BHEL):
Signature:
Name: _____ Designation: _____

Verified by Customer Representative (if applicable), Name: _____ Sign: _____ Date: _____ Time: _____

(* Permit valid for 7 days, subject to daily renewal, and extension as per overleaf instructions / record formats)

Lockout/Tagout Work Permit No. & Date:
_____**Daily Work Area Condition Endorsement**

Sl. No.	Date	Signature with Date & Time		Remarks
		Agency Safety	BHEL Safety	
Day 2				
Day 3				
Day 4				
Day 5				
Day 6				
Day 7				

Permit Extension Beyond Initially Requested Hours

Sl. No.	Extension Period		Remarks	Signature with Date & Time			
	From..... (Date & Time)	To..... (Date & Time)		Agency Site Engineer	Agency Safety Officer	BHEL Site Engineer (PIA)	BHEL Safety Officer
1.							
2.							
3.							
4.							
5.							
6.							

TO BE SIGNED BY THE BHEL HSE & EXECUTION AFTER THE WORK IS OVER

Permit is here by returned after completing the job & ensuring safe removal of men and material.

Site Engineer, BHEL		Site HSE Engineer, BHEL	
Signature:		Signature:	
Name:		Name:	

General Instructions:

1	This Permit is required for all maintenance and erection activities with danger of electrocution from Live Electric Power
2	This permit must be available at the work site all the times of the work.
3	Location and description of the work, and terms applicable must be clearly indicated by the permittee.
4	This permit shall be endorsed each day after checking all the compliance jointly by the contractor and BHEL safety.
5	Permit shall be issued for not more than 7 days including the issue date.
6	Permit shall be returned to the HSE Department of BHEL after completion of the job.
7	Before engaging anybody to work, competency and fitness to be ensured.
8	All safety precautions to be taken as per work site HSE plan.
9	Distribution of copy: Original- Permittee, Duplicate –Department HOS, Contractor, Triplicate - Site HSE Dept.



POWER SECTOR

FORMAT NO: HSEP:14-F01

REV NO.: 00

PAGE NO. 01 OF 02

Inspection of First Aid Box

Name of Site:	
Name of Sub-Contractor:	
Inspected by:	
Date of Inspection:	

Number of employees in the site: - _____

Sl. No.	Item	No. Available	Remarks
1	No. of small sterilized dressings		
2	No of medium sized sterilized dressings		
3	No of large sized sterilized dressings.		
4	No of large sized sterilized burn dressings		
5	No of (15 grams) packets sterilized cotton wool		
6	No of pieces of sterilized eye pads in separate sealed packets.		
7	No of roller bandages 10 cm wide.		
8	No of roller bandages 5 cm wide.		
9	Whether tourniquet available		
10	Whether supply of suitable splints available.		
11	No of packets of safety pins.		
12	Whether kidney tray available		
13	Whether sufficient number of eye wash bottles, filled with distilled water or suitable liquid, clearly indicated by a distinctive sign which shall be visible at all times, available.		
14	Whether 4%-xylocaine eye drops, and boric acid eye drops and soda by carbonate eye drops available.		
15	Whether (60ml) bottle containing a two percent alcoholic solution of iodine available		
16	Whether (two hundred ml) bottle of mercurochrome (2 per cent) solution in water available.		
17	Whether 120ml bottle containing Sal volatile having the dose and mode of administration indicated on the label,		
18	Whether roll of adhesive plaster (6 cm X 1 meter) available		



POWER SECTOR

FORMAT NO: **HSEP:14-F01**

REV NO.: 00

PAGE NO. 01 OF 02

Inspection of First Aid Box

Sl. No.	Item	No. Available	Remarks
19	No of rolls of adhesive plaster (2 cm X 1 meter)		
20	Whether snake bite lancet available.		
21	Whether (30 grams) bottle of potassium permanganate crystals available.		
22	Whether a pair scissors available		
23	Whether copy of the First-Aid leaflet issued by the Director-General, Factory Advice service and labor Institutes, Government of India available.		
24	Whether bottle containing 100 tablets (each of 5 grains) of aspirin available		
25	Whether Ointment for burns available		
26	Whether bottle of a suitable surgical anti-septic solution available		
27	Whether List of Contents pasted on First Aid Box along with respective expiry dates		

Signature of Subcontractor's Site I/C

Date:

	POWER SECTOR	FORMAT NO: HSEP:14-F02
	Health Check-Up	REV NO.: 00 PAGE NO. 01 OF 02

Name of Site:	
Name of Sub-Contractor:	
Name of Employee:	
Age:	

History Of Past Illness	H/O Epilepsy:	
	H/O Drug Allergy:	
	H/O Diabetics/ Hypertension:	
	H/O Unconsciousness:	
Personal History		

EXAMINATION		OBSERVATION	
General Physical Examination			
Height			
Weight			
BMI			
Built And nourishment			
Pallor			
Temperature			
Chest Expansion	Inspiration	Expansion	
Lymph Node Enlargement			
Upper Limbs Strength & Function			
Lower Limbs Strength & function			
Spine Adequately flexible for the job concerned (Yes/No)			
Mental alertness and stability with good eye, hand and foot co-ordination.			
Ear, Nose, Throat			
Ear / Hearing			
Nose			
Throat			
Vision			
	Left Eye	Right Eye	

**POWER SECTOR****Health Check-Up**FORMAT NO: **HSEP:14-F02**

REV NO.: 00

PAGE NO. 02 OF 02

EXAMINATION		OBSERVATION	
<u>Cardiovascular System Examination</u>			
Inspection			
Palpation	Pulse	BP	
Auscultation (Heart Sounds)			
<u>Respiratory System</u>			
Inspection	Respiratory Rate		
Palpation:			
Percussion			
Auscultation (Breath Sounds)			
<u>Examination of Abdomen</u>			
Inspection			
Palpation			
Auscultation (Bowel Sounds)			
Any Other			
Clinical Impression			

Signature of the examining doctor

Date:



POWER SECTOR

HSE Induction / Regular / On-the-Job Training Records

FORMAT NO: HSEP:14-F03

REV NO.: 02

PAGE NO. 01 OF 01

Name of Site:					
Name of Sub-Contractor:					
Date of Training (dd/mm/yyyy):		Duration (Hrs)			
		From		To	
Name & Details of Trainer:					
Subject of Training	Induction		On-The-Job Training (Give details)		
Name of Training Co-ordinator:					

Sl. No.	Name	Designation	Organization	Signature

I certify that Training has been carried out as per HSEP04: HSE Procedure for Training & Awareness

Signature of Training Coordinator

Date:



POWER SECTOR

Toolbox Talk

FORMAT NO: HSEP:14-F04

REV NO.: 00

PAGE NO. 01 OF 01

Name of Site :	
Sub-Contractors Name :	
Date :	

Topic	Name of person delivered Tool Box Talk	No. of Participants attended	Remarks

Signature of Site I/C of Subcontractor

Date:



POWER SECTOR

Monthly Site HSE Report

FORMAT NO: HSEP:14-F05

REV NO.: 00

Page 01 of 6

Name of subcontractor:	Report Month:

A) Accidents/Incidents Details: -

a	Lost time in Accidents	No. of incidents	Man Hours Lost	No. of People Involved	No. of person reported to Govt.	
	For the Month					
	Cumulative					
b	Minor Injuries					
	For the Month					
	Cumulative					
c	Fires	No. of Near-Misses	No. of First- Aid cases	No. of persons injured	No. of equipment damaged	No. of Fire reported Outside
	For the Month					
	Cumulative					
d	Other mishaps not covered in a, b, c.	No. of Near-Misses	No. of First- Aid cases	No. of persons injured	No. of equipment damaged	Total near misses and First-Aid
	For the Month					
	Cumulative					

B) Data for Man-hours worked:

Details	Value	Remarks if any
No. of people		
Man Hours worked		
O.T. Hours		
Total Man Hours		
Grand Total of man hours worked during the month(A+B)		
Cumulative man-hours (from _____ to _____): (Since commencing of operations)		

Signature of Subcontractor Site In-charge

Signature of Subcontractor HSE Officer



POWER SECTOR

Monthly Site HSE Report

FORMAT NO: HSEP:14-F05

REV NO.: 00

Page 02 of 6

C) Status of Deployment of Work force, Safety Officers/Supervisors & Construction Medical Officer(s) & Electricians:

Description	Name	Qualification & Experience
Safety Officers		
Safety Supervisors		
Construction Medical Officer		
Nursing Staff.		
Electricians		
Scaffolding Inspectors		
T&P Inspectors		

D) Status of deployment of manpower for critical HSE activities:

(All height work and other hazardous activities to be actively supervised by trained personnel. Area to be divided in manageable sections to ensure effective supervision at all times. For example, multiple elevations in a structure can be divided among multiple supervisors)

Activity	Location	Shift Timings	Personnel deployed	Remarks
Height Work	Boiler Unit- (Level 1-3)			
	Boiler Unit- (Level 4-6)			
	ESP			
Housekeeping	Boiler Unit-			
	ESP Unit			
Others				

Signature of Subcontractor Site In-charge

Signature of Subcontractor HSE Officer



POWER SECTOR

Monthly Site HSE Report

FORMAT NO: HSEP:14-F05

REV NO.: 00

Page 03 of 6

E) Lifting Tools, Tackles, Equipment and Pressure Vessels:

Item	Nos. Deployed	Nos. Tested by competent person	Identification Nos. (Comma separated) (A)	Validities of Test Certificates (Comma separated – corresponding to column A)	Whether internal testing using Color Coding or similar system done
Winches					
Chain Blocks					
Wire Rope Slings					
Man Cages					
D-Shackles					
Air Compressors					
Crawler Cranes					
Mobile Cranes					
Hydra Cranes					
Hydraulic Jack					
Others					

F) Reverse Horns in Construction Vehicles:

Item	Nos. Deployed with serial numbers (Comma separated) (A)	Nos. Having Functional reverse horns	Inspection Dates (Comma separated corresponding to column A)
Transit Mixers			
Hydra Cranes			
Dumpers/Trippers			
Backhoes			
Other Vehicles			

G) ELCBs:

No. Of ELCBs provided with Serial Nos. (Comma separated) (A)	Nos. Functional	When They were last Tested (Comma separated corresponding to column A)

H) Electrical Earthing:

No. Of Earth resources with serial numbers and locations (Comma separated) (A)	Whether Double Earthing provided to all equipment	When they were last tested (Comma separated corresponding to column A)

Signature of Subcontractor Site In-charge

Signature of Subcontractor HSE Officer

	POWER SECTOR	FORMAT NO: HSEP:14-F05
	Monthly Site HSE Report	REV NO.: 00 Page 04 of 6

I) Fire Extinguishers

Name & designation of person responsible for maintenance of Extinguishers at different locations :(Individual subcontractor's Safety Officers).

A. FIRE EXTINGUISHERS AT ERECTION SITE:

Type (Add more rows if required)	Sizes	Qty + Serial numbers (Comma separated) (A)	Healthiness – Last checked dates (Comma separated corresponding to column A)	Locations (Comma separated corresponding to column A)
FOAM TYPE				
SODA TYPE				
DRY TYPE (DCP)				
CO2 TYPE				

B. FIRE EXTINGUISHERS AT SITE OFFICES & STORES:

Type	Size (Add more rows if required)	Qty + Serial numbers (Comma separated) (A)	Healthiness – Last checked dates (Comma separated corresponding to column A)	Locations (Comma separated corresponding to column A)
FOAM TYPE				
SODA TYPE				
DRY TYPE (DCP)				
CO2 TYPE				

J) Tie-Ups with Emergency Services

Service (Add more rows if required)	Name, location & distance from site	Emergency contact details	Remarks
Hospital with ICU and facilities for orthopedic, neurological etc. trauma			
Fire services			
Others:			

Signature of Subcontractor Site In-charge

Signature of Subcontractor HSE Officer



POWER SECTOR

Monthly Site HSE Report

FORMAT NO: HSEP:14-F05

REV NO.: 00

Page 05 of 6

K) Implementation of Checklist, Work Permits:

Item	Numbers During the Month	Major Deviations

Note:- Please attach photocopies of all filled Checklists & Work permits for that month.

L) Personal Protective Equipment Issued (Extend table for each subcontractor):

Item	Issued this Month	Nos. Issued up to the Month	Percentage of usage at Site (as per physical verification)
Name of subcontractor:			
Safety Helmet			
Safety Shoes			
Full Body Harness			
Fall Arrestor			
Safety Nets			
Hand Gloves			
Face shield			
Welder shield			
Nose Mask			
Reflective Jacket			
Other PPEs.			

M) Safety Observations by Subcontractor Executives- Observations package wise:

Topic	Date Of Programme	No. Of Participants	Level Of Participants

• Tool-Box talks on Safety:

Date	Tool Box Talk - No of Participants	Topic	Remarks

• Safety Induction Trainings:

Date	Safety Induction No. of Participants	Topic	Remarks

Signature of Subcontractor Site In-charge

Signature of Subcontractor HSE Officer



POWER SECTOR

Monthly Site HSE Report

FORMAT NO: HSEP:14-F05

REV NO.: 00

Page 06 of 6

N) Progress of Management Programmes at Site

SL	Description Of MPs	Annual Plan	Achievement In This Month	Cumulative Achievement
A. Environment Improvement Programme				
1	Plantation of Trees			
2	Installation of Scrap Bins			
3	Chemical Storage & Handling system			
B. Improvement of Working Environment				
4	Increasing LTI free days			
5	Air Quality Monitoring			
6	Water Quality Monitoring			
7	Illumination level Monitoring			

O) HR Information:

Designation	Total No. Inducted	Total no. of Induction Balance	Total no. of Gate Pass Issued	Total no. of Gate Pass Balance	Total no. of Gate Pass Cancelled	Medical Checkup Completed	Medical Checkup Balance

P) Rewards on Account of Good Safety Performance

Serial Number	Reward Issued to	Details of Reward Issued (Amount etc.)	Brief Reason

Note: Photos of Reward Functions to be attached

Q) Other Safety initiatives / Safety Activities conducted (with photos, if any):

Signature of Subcontractor Site In-charge

Signature of Subcontractor HSE Officer



POWER SECTOR

Personal Protective Equipment Inspection

FORMAT NO: HSEP:14-F06

REV NO.: 00

PAGE NO. 01 OF 01

Name of Site :	
Name of Sub-Contractor :	
Inspected by :	
Date of Inspection:	

Item	Total Checked	Numbers Found in Order	Remarks
Safety Helmet			
Safety Shoes			
Full Body Harness			
Fall Arrestor			
Safety Nets			
Hand Gloves			
Face shield			
Welder shield			
Nose Mask			
Reflective Jacket			
Other PPEs (Specify)			

Signature of Site I/C of Subcontractor:

Date:

	POWER SECTOR	FORMAT NO: HSEP:14-F07 REV NO.: 00 PAGE NO. 01 OF 01
	Inspection Of T&Ps	

Name of Site :	
Name of Sub-Contractor :	
Date of Inspection :	

SI.No.	Description	Remarks
1.0	Name of equipment	
2.0	Basic Information of equipment	
2.1	Specification	
2.2	Sr. No. of equipment	
2.3	Make	
2.4	Year of manufacture	
3.0	Major repairs / overhauls(Furnish details of work carried out)	Date(s) of major repair/overhaul
3.1		
3.2		
3.3	Repairs carried out at site	
4.0	Any performance test conducted	Yes/No
5.0	Document Submitted	Yes/No
6.0	Manufacturer's test / guarantee certificate	Available/ Not available
7.0	Performance test	Done/ Not Done
8.0	Acceptance Norms	
9.0	Committee Observations	
10.0	Date of next review (if accepted)	
Signature-Subcontractor HSE Officer		Signature-Subcontractor Site In-charge



POWER SECTOR

Inspection Of Cranes

FORMAT NO: HSEP:14-F08

REV NO.: 00

PAGE NO. 01 OF 01

Name of Site :
Name of Sub-Contractor :
Inspected by :
Date of Inspection:
Crane Reg. No (Make/Model) _____

Name of Driver/Operator _____

Sl.no.	Description	Observation	Measures
1	Valid Driving license		
2	Hook & Hook Latch		
3	Over Hoist limit switch		
4	Boom limit switch		
5	Boom Angle Indicator		
6	Boom limit cutoff switch		
7	Condition of Boom		
8	Condition of ropes		
9	Number of load lines		
10	Size and condition of the slings		
11	Stability of the cranes		
12	Soil Condition		
13	Swing Break And Lock		
14	Proper Break And Lock		
15	Hoist Break And Lock		
16	Boom Break And Lock		
17	Main Clutch		
18	Leakage in Hydraulic Cylinders		
19	Out riggers fully extendable		
20	Tyre pressure		
21	Condition of Battery And Lamps		
22	Guards of moving and rotating parts		
23	Load chart provided		
24	Number and position of pedant ropes		
25	Reverse Horn		
26	Load Test Details		
27	Operator's fitness		
28	Pollution under control certificate		
29	Fire extinguisher of appropriate type.		
30	Training of the operator		

Signature of Site I/C of Subcontractor:
Date:



POWER SECTOR

Inspection Of Winches

FORMAT NO: HSEP:14-F09

REV NO.: 00

PAGE NO. 01 OF 01

Name of Site :	
Name of Sub-Contractor :	
Inspected by :	
Date of Inspection:	

Winch Reg. No (Make/Model) _____

Name of Operator _____

Sl. No.	Description	YES	NO	NA	Remarks
1	Has the copy of Third Party Inspection certificate been provided in winch machine shed?				
2	Is safe operating instructions displayed near winch?				
3	Is winch machine operator experienced enough to operate the winch machine?				
4	Is the winch machine operated by someone other than the winch machine operator?				
5	Is there guard provided in all moving parts like wheel and motor's shaft?				
6	Will it protect against unforeseen operational contingencies?				
7	Are brakes, clutch and locking arrangement working properly?				
8	Has it been ensured that the guard does not constitute a hazard by itself?				
9	Are the cranks and the connecting rods protected by guardrails?				
10	Is there provision for fully covered shed with wooden plank roof?				
11	Is wire rope free from any kind of damage or wear and tear?				
12	Is split pin provided for the protection of clutch and brake locking arrangement?				
13	Is pulley inspected by competent person and certified before use?				
14	Is pulley free from any wear and tear visually?				
15	Is winch rope barricaded with clipsheet for the protection of rope and person?				
16	Is the wire rope lubricated by cardium oil?				
17	Is there any friction in wire rope which may damage the wire rope rather than the rolling parts?				
18	Is there any oil leakage in the hydraulic system of the winch machine?				
19	Has it been ensured that the guard will not cause discomfort or inconvenience to operator?				
Total NO					
Total NA					
		% Compliance			

Signature of Site I/C of Subcontractor: _____

Date: _____



POWER SECTOR

Inspection of Height Working

FORMAT NO: HSEP:14-F10

REV NO.: 00

PAGE NO. 01 OF 2

Name of Site :	
Name of Sub-Contractor :	
Inspected by :	
Date of Inspection:	

Sl. No.	Descriptions	Observation (Yes/No)	Remarks
A. General			
1	All the workers have been explained safe work method?		
2	Adequate illumination has been ensured.		
3	Work area inspected prior to the start of the work.		
4	Is the work area barricaded to prevent fall and platforms are of adequate strength (bamboo, jute / plastic ropes not to be used).		
5	The temporary work platforms & structures for height work including those used in Boiler structures, water walls, ESP, Powerhouse are fully barricaded with railings (as per IS 3696)		
6	Fabricated makeshift arrangements are checked for quality and type of material welding, anchoring etc.		
7	Are floor gaps, permanently covered and barricaded		
8	Area below the work place barricaded, particularly below hot work.		
9	Workers provided with bags /box to carry bolts, nuts and hand tools		
10	Arrangement for fastening hand tools made.		
11	All work platforms ensured to be of adequate strength and ergonomically suitable.		
12	Work at more than one elevation at the same segment is restricted.		
13	An established communication system has been established and explained to the workers.		
B. Access/Egress			
1	Walkways provided with handrail, mid-rail and toe guard?		
2	All checkered plates, gratings properly welded/ bolted?		
3	Are ladders inspected and they are in good condition?		
4	Are ladders spliced?		
5	Are ladders properly secured to prevent slipping, sliding or falling?		
6	Stairs erected above and below 1 tier column for safe access?		
7	Do side rails extend 36" above top landing?		



POWER SECTOR

Inspection of Height Working

FORMAT NO: HSEP:14-F10

REV NO.: 00

PAGE NO. 02 OF 2

Sl. No.	Descriptions	Observation (Yes/No)	Remarks
8	Are built up ladders constructed of sound materials?		
9	Are rugs and cleats not over 12" on center?		
10	Metal ladders not used around electrical hazards.		
11	Proper maintenance and storage.		
12	Ladders placed at right slope.		
13	Ladders / staircases welded/ bolted properly.		
14	Any obstruction in the stairs.		
15	Are landing provided with handrails, knee rails, toe boards etc.?		
16	Whether ramp is provided with proper slope.		
17	Proper hand rails / guards provided in ramps.		
C. Housekeeping			
1	Walkways, aisles & all overhead workplaces cleared of loose material.		
2	Is any nut bolt/scrap left on beam/column?		
3	Flammable materials, if any, are cleared.		
4	All the de shuttering materials are removed after de shuttering is done.		
5	Platforms and walkways free from oil/grease or other slippery material.		
6	Collected scrap are brought down or lowered down and not dropped from height.		
D. PPE And Safety Devices			
1	Use of safety helmet, safety belts ensured for all workers		
2	Anchoring points provided at all places of work.		
3	Common lifeline provided wherever linear movement at height is required.		
4	Safety nets are use wherever required.		
5	Proper fall arrest system is deployed at critical workplaces.		
6	Crawler boards/Safety system or works on fragile roof are used.		
7	Is man-lift being used for personnel lifting?		
8	Does man basket / personnel lift system has an independent lifeline and all occupants safety harnesses connected to it with rope grab?		

Signature of Site I/C of Subcontractor:

Date:



POWER SECTOR

FORMAT NO: HSEP:14-F11

REV NO.: 00

PAGE NO. 01 OF 02

Inspection of Welding and Gas Cutting

Name of Site :	
Name of Sub-Contractor :	
Inspected by :	
Date of Inspection :	

Welding				
Sl.no.	Description	Y e s	N o	Remarks
1	Is electric connection given through 30 mA ELCB/RCCB to welding m/c?			
2	Is welding machine more than 10 years old?			
3	Is there provision of fuse and is it bypassed?			
4	Is electric cable fitted properly in junction box on m/c?			
5	Is electrical cable free from joints?			
6	Are the joints attached firmly & insulated with tape?			
7	Is double earthing given to body of m/c?			
8	Is the physical condition of the m/c good?			
9	Is ON/OFF switch connected to the m/c is working and in good condition?			
10	Are indication lamps on m/c working?			
11	Is the electrode holder in good condition?			
12	Are the cables of the welding m/c lugged & tight properly?			
13	Is cable to welding machine terminal joint lose / burnt / glowing?			
14	Are return lead connected properly (Rod, Angle, Channels shall not be used)			
	Total No of NO			
	Total No of YES			

Signature of Site I/C of Subcontractor:

Date:



POWER SECTOR

Inspection of Welding and Gas Cutting

 FORMAT NO: **HSEP:14-F11**

REV NO.: 00

PAGE NO. 02 OF 02

Gas Cutting

Sl.no	Description	Yes	N o	Remarks
1	Are Cylinders kept on trolleys?			
2	Physical condition of Gas cylinders Good?			
3	Is there Oil/Grease on valve of the cylinder?			
4	Are pressure regulators in good condition?			
5	Condition of hose pipe OK?			
6	Are hose pipe clamped with hose clip?			
7	Is flash back arrestor & NRV fitted on torch both for O2 and LPG cylinder?			
8	Is nozzle of the torch cleaned?			
	Total Number of NO			
	Total No of YES			
	% Compliance			

Signature of Site I/C of Subcontractor:

Date:

**POWER SECTOR****Inspection Of Electrical Installation**

FORMAT NO: HSEP:14-F12

REV NO.: 00

PAGE NO. 01 OF 02

Name of Site :	
Name of Sub-Contractor :	
Inspected by :	
Date of Inspection :	

Sr. No.	Contents	Yes/No	Remarks
A	Cable		
1.	Whether the condition of cable is checked?		
2.	Are cables received from other sites checked for insulation resistance before putting them into use?		
3.	Are all main cables taken either underground / overhead?		
4.	Are welding cables routed properly above the ground?		
5.	Are welding and electrical cables overlapping?		
6.	Is any improper joining of cables/wires prevailing at site?		
B	DBs/SDBs		
1.	Is earth conductor continued up to DB / SDB?		
2.	Whether DBs and extension boards are protected from rain / water?		
3.	Whether DB and extension board have separate MCB/ELCB		
4.	Is there any overloading of DBs / SDBs?		
5.	Are correct / proper fuses & CBs provided at main boards and sub-boards?		
6.	Is energized wiring in junction boxes, CB panels & similar places covered all times?		
C	ELCB		
1.	Whether the connections to all equipment are routed through individual ELCBs?		
2.	Is sensitivity of each ELCB maintained at 30 mA?		



POWER SECTOR

INSPECTION OF ELECTRICAL INSTALLATION

FORMAT NO: HSEP:14-F12

REV NO.: 00

PAGE NO. 02 OF 02

Sr. No.	Contents	Yes/No	Remarks
3.	Are the ELCB numbered and tested periodically & test results recorded in a logbook countersigned by a competent person?		
D	Grounding		
1.	Is natural earthing ensured at the source of power (main DB at Generator or Transformer)?		
2.	Whether the continuity and tightness of the earth conductor are checked?		
3.	Mention the gauge of the earth conductor used at the site.		
4.	Mention the value of Earth Resistance.		
E	Electrically operated Machines or Accessories.		
1.	Whether the plug top is provided everywhere.		
2.	Are all metal parts of electrical equipment and light fittings / accessories grounded / double earthed?		
3.	Is there any shed or cover for welding machines?		
4.	Are halogen lamps fixed at proper places?		
5.	Are portable power tools maintained as per norms?		
6.	Any other information:		

Signature of Site I/C of Subcontractor:

Date:

	POWER SECTOR	FORMAT NO: HSEP:14-F13 REV NO.: 00 PAGE NO. 01 OF 01
	Inspection of Elevator	

Name of Site :	
Name of Sub-Contractor :	
Inspected by :	
Date of Inspection :	

Sr. No.	Description	Remarks
1.0	Name of equipment	
2.0	Basic Information of equipment	
2.1	Specification	
2.2	Sr. No. of equipment	
2.3	Make	
2.4	Year of manufacture	
3.0	Major repairs/overhauls(Furnish details of work carried out)	Date(s) of major repair/overhaul
3.1		
3.2		
3.3	Repairs carried out at site	
4.0	Any performance test conducted	Yes/No
5.0	Document Submitted	Yes/No
6.0	Manufacturer's test / guarantee certificate	Available/ Not available
7.0	Performance test	Done/ Not Done
8.0	Acceptance Norms	
9.0	Committee Observations	
10.0	Date of next review (if accepted)	

Signature-Subcontractor/ Subcontractor's Safety Officer

Signature-Site Safety Officer (BHEL)

	POWER SECTOR	FORMAT NO: HSEP:14-F14 REV NO.: 00 PAGE NO. 01 OF 2
	HSE Penalty Format	

Sub: MEMO for Penalty for non-compliances in Safety and Fabrication Quality requirement

Following lapse (tick marked) was observed and penalty is imposed as stated at the bottom of this memo. It is requested that such occurrences may please be avoided in future.

S. No	Nature of Non - Compliance	Penalty (in Rs.)	Remarks
A. PPEs			
1.	Not wearing safety helmet / wearing without chin straps	500	Per Person/ day
2.	Not Wearing safety shoes	500	Per Person/ day
3.	Not wearing gloves, nose masks where required	350	Per Person/ day
4.	Not using grinding goggles while doing grinding operations	500	Per Person/ day
B. Height Work			
1.	Not providing Lifelines for height work	1000	Per location per day
2.	Not ensuring barricading of working platforms	1000	Per location per day
3.	Not using temporary platform during work at height	1000	Per case per day
4.	Not wearing safety belt while working at height (> 2 meters) or not anchoring to lifeline	2000	Per Person/ day
5.	Not providing proper barricades (caution tape at 2 elevations)	500	Per location per day
	Use of mobile phones by Height worker / Crane / Hydra Operator	1000	Per case per day
C. Electrical			
1.	Not using 24 V supply for lighting in confined spaces	500	Per case per day
2.	Lack of Electrical Earthing	2000	Per case per day
3.	Improper earthing of welding & Other electrical Machines. Earth resistance not OK	500	Per Machine per incidence
4.	Electrical plug not used for connection/ hand machines	500	Per connection per incidence
5.	Unsafe electrical practice like not installing ELCB/ RCCB	500	Per case per day
6.	Using frayed/ broken welding cables	500	Per machine per week
D. Lifting			
1.	Use of lifting equipment without having valid Third Party Test certificate	5000	Per equipment per seven days
2.	Lifting hooks without latches	500	Per hook per day
3.	Using damaged slings or not slinging properly	2000	Per event Per T&P
4.	Lifting cylinders without cage or rolling of cylinders	500	Per Event per incidence
5.	Non removal of scrap from platforms	1000	Per Event Per location per 7 days
E. Hot Work / Cylinder Handling			
20.	Gas cutting without flash back arrestor	2000	Per machine per incidence
21.	Gas cutting at height without sheet below	500	Per event
22.	Not keeping gas cylinders vertically / in trolley on ground	500	Per event
23.	Gas cutting with damaged hose pipes	500	Per event
	Not covering welding cylinder with top cover	500	Per event
F. Construction Vehicles			
24.	Not having valid driving license for the type of vehicle/ T&P	2000	Per driver per event
25.	Two wheeler entry in construction area	500	Per vehicle
26.	Using Hydra for material movement at site in unsafe manner	1000	Per case
27.	Using Two Hydra in Tandem for material movement	2000	Per case
28.	Vehicles, Hydras, Cranes, Dumpers and Earth Movers not having automatic back horns linked to gear	1000	Per Equipment per day
29.	Not using guide rope while moving material using Hydra or Crane	1000	Per event
30.	Violating speed limit during vehicle movement	1000	Per event

	POWER SECTOR	FORMAT NO: HSEP:14-F14 REV NO.: 00 PAGE NO. 02 OF 2
	HSE Penalty Format	

	Nature of Non - Compliance	Penalty in Rs.)	Remarks
Engineering / Administrative Controls / General			
31.	Major Accident – Victim not reporting for work within 48 hours – resulting in partial loss in earning capacity & termination / demotion in employment	200000	
32.	Fatal Accident/Accidents Resulting in total Loss in Earning Capacity #	500000	Per victim#
33.	Unsafe Act in violation of standards / clauses of this document	500-5000	Per case
34.	Activity carried out without safety work permit where applicable	2000	Per person per event
35.	Using untrained / unqualified personnel for hazardous work	2000	Per event
36.	Not maintaining proper hygiene in canteen as per BOCW	1000	Per event

or as deducted by customer, whichever is higher.

For repeated **major and** fatal incidents under the same subcontractor for the same package in the same Unit, the subcontractor will pay 2 times the penalty compared to previously paid

Details (if any) related to non- compliance (Name of persons, Nature of deficiency, etc.)

Penalty imposed:

1, Rate as per above chart _____

2. No. of Persons/ machine/ event/ labor _____

3. Total Penalty= 1. X 2. = _____

BHEL Personnel:

Signatures:

Name _____

Attachments: Photographs & Documentary proof (if available) for violation

Distribution: 1 Copy: to Sub- contractor Site In-charge,
1 Copy to Site Construction Manager (BHEL)



POWER SECTOR

Format for Initial Verification of PPE's & Lifting Tools & Tackles

FORMAT NO: HSEP:14-F15

REV NO.: 00

PAGE NO. 01 OF 1

Name of Site :	
Name of Sub-Contractor :	
Inspected by :	
Date of Inspection :	

S. No	Particulars (Serial Number, make, model of PPE, T&P)	Accepted / Rejected	Remarks
Checked (Name & Sign. Of Subcontractor HSE Officer)		Verified (Name & Sign. Of Subcontractor Site In-charge)	

**POWER SECTOR****Format for Inspection of Labor Colony**

FORMAT NO: HSEP:14-F16

REV NO.: 00

PAGE NO. 01 OF 1

Name of Site :	
Name of Sub-Contractor :	
Inspected by :	
Date of Inspection :	

S. No	Particulars	No	Yes	Comments
1	Sufficient living space ensured for each occupant with Kitchen area			
2	Area cleanliness ensured through regular cleaning			
3	Toilet facility sufficient for all occupants available, in order with adequate lighting, cleaned regularly and in hygienic condition			
4	Washing facilities available with adequate water supply			
5	Availability of sufficient drinking water in protected tanks with weekly tank cleaning and source tested annually as per IS10500 ensured			
6	Adequate drainage to remove waste and rain water, no flooding			
7	"Unsafe for Drinking" posted near accessible non-potable water and sources; posted in language of occupants or universal symbol			
8	Prevention of mosquitoes, flies, and rodents in immediate housing area through insecticide sprays if required			
9	Electricity provided & electrical connections safety ensured			
10	Fans, Coolers / Quilts, Heaters provided as required to cater to weather conditions along with adequate electricity supply			
11	Houses Walls and roof tight and solid; floors rigid and durable, with smooth, cleanable finish in good repair			
12	Availability of nominal rate ration / common use items shop within / nearby the colony			
13	Emergency medical plan developed: (A) Potential injuries determined (B) Local EMS response determined (C) Qualified first-aid person on site, if required			
14	Emergency plans posted where employees gather			
15	Transportation to nearest suitable facility			

Any other checks:

Remarks:				
		Name & Sign. Of Subcontractor HSE Officer		

**POWER SECTOR****Format for Maintaining Records of E-waste
Handled / Generated**

FORMAT NO: HSEP:14-F18

REV NO.: 00

PAGE NO. 01 OF 1

(Generated Quantity in Metric Tons (MT) per year)

Site		
Subcontractor		
Date		
Types & Quantity of e-waste handled/generated**	Category	Quantity
	Item Description	
Types & Quantity of e-waste stored	Category	Quantity
	Item Description	
Types & Quantity of e-waste sent to collection center authorized by producer/dismantler/recycler/refurbisher or authorized dismantler/ recycler or refurbisher **	Category	Quantity
	Item Description	
Types & Quantity of e-waste transported*	Category	Quantity
	Item Description	
Name, address and contact details of the destination		
Types & Quantity of e-waste refurbished*	Category	Quantity
	Item Description	
Name, address and contact details of the destination of refurbished materials		
Types & Quantity of e-waste dismantled*	Category	Quantity
	Item Description	
Name, address and contact details of the destination		
Types & Quantity of e-waste recycled*	Category	Quantity
	Item Description	
Types & Quantity of materials recovered	Item Description	
	Quantity	
Name, address and contact details of the destination		
Types & Quantity of e-waste sent to recyclers by dismantlers	Category	Quantity
	Item Description	
Name, address and contact details of the destination		
Types and Quantity of other waste sent to respective recyclers by dismantlers / recyclers of e-waste	Category	Quantity
	Item Description	
Name, address and contact details of the destination		
Types and Quantity of e-waste treated & disposed	Category	Quantity
	Item Description	
Name, address and contact details of the destination		

Signature of Subcontractor Site In-charge:**Date**

**POWER SECTOR****Format for Maintaining Records of Hazardous Waste at the Facility**

FORMAT NO: HSEP:14-F19

REV NO.: 00

PAGE NO. 01 OF 1

1. Name of Site:
2. Name of the Subcontractor:
3. Date:
4. Description of hazardous waste:

Physical form with description	Chemical form	Total volume and weight (in kg.)

5. Description of storage and treatment of hazardous waste:

Date	Method of storage of hazardous wastes	Date	Method of treatment of hazardous wastes

6. Details of transportation of hazardous waste:

Name & address of consignee of package	Mode of packing/of the waste for transportation	Mode of transportation to site of disposal	Date of transportation

7. Details of disposal of hazardous waste:

Date of disposal	Concentration of hazardous material in the final waste form	Site of disposal (identify the location on the relevant layout drawing for reference)	Method of disposal	Persons involved in disposal

8. Data of environmental surveillance:

Date of measurement	Analysis of ground water			Analysis of soil samples			Analysis of air sampling			Analysis of any other samples (give details)
	Location of sampling	Depth of sampling	Data	Location of sampling	Depth of sampling	Data	Location of sampling	Data		

9. Details of the hazardous wastes reused and recycled:

Date	Total quantity of hazardous waste generated	Details of hazardous waste minimization activity	Material received	Final quantity of waste generated	Net reduction in waste generation quantity and percentage

Signature of Subcontractor Site In-charge:

Date:

**POWER SECTOR****HSE Audit / Inspection Checklist-cum-Compliance Report**

FORMAT NO: HSEP:14-F20

REV NO.: 00

PAGE NO. 01 OF 3

PROJECT: _____

CONTRACTOR: _____

DATE: _____

OWNER : _____

INSPECTION BY: _____

Note : write 'NA' wherever the items is not applicable

Item	Y e s	N o	Remarks	Action
HOUSEKEEPING				
Waste containers provided and used				
Passageways and walkways clear				
General neatness of working area				
Other				
PERSONNEL PROTECTIVE EQUIPMENT				
Goggles; shields				
Face protection				
Hearing protection				
Respiratory masks etc.				
Safety belts				
Other				
EXCAVATIONS / OPENINGS				
Openings properly covered or barricaded				
Excavations shored				
Excavations barricaded				
Overnight lighting provided				
Other				
WELDING, CUTTING				
Gas cylinders chained upright				
Cable and hoses not obstructing				
Fire extinguisher (s) accessible				
Others				
SCAFFOLDING				
Fully decked platforms				
Guard and intermediate rails in place				
Toe boards in place				
Adequate shoring				
Adequate access				
Others				
LADDER				
Extension side rails 1 m above				
Top of landing				
Properly secured				
Angle + 70° from horizontal				
Other				

**POWER SECTOR****HSE Checklist-cum-Compliance Report**

FORMAT NO: HSEP:14-F20

REV NO.: 00

PAGE NO. 02 OF 3

HOISTS, CRANES AND DERRICKS				
Condition of cables and sheaf OK				
Condition of slings, chains, hooks OK				
Inspection & maintenance log maintained				
Outriggers used				
Signals observed and understood				
Qualified operators				
Others				
MACHINERY, TOOLS & EQUIPMENT				
Proper instruction				
Safety devices				
Proper cords				
Inspection and maintenance				
Other				
VEHICLE AND TRAFFIC				
Rules and regulations observed				
Inspection and maintenance				
Licensed drivers				
Other				
TEMPORARY FACILITIES				
Emergency instructions posted				
Fire extinguishers provided				
Fire-aid equipment available				
General neatness				
Others				
FIRE PREVENTION				
Personnel instructed				
Fire extinguishers checked				
No smoking in prohibited areas.				
Hydrants				
Clearance				
Others				
ELECTRICAL				
Proper wiring				
ELCB's provided				
Ground fault circuit interrupters				
Protection against damage				
Prevention of tripping hazards				
Other				
HANDLING & STORAGE OF MATERIALS				
Properly stored or stacked				
Passageways clear				
Other				
FLAMMABLE GASES AND LIQUIDS				
Containers clearly identified				
Proper storage				
Fire extinguisher nearby				
Other				



POWER SECTOR

HSE Checklist-cum-Compliance Report

FORMAT NO: HSEP:14-F20

REV NO.: 00

PAGE NO. 03 OF 3

WORKING AT HEIGHT				
Safety nets				
Safety belts				
Safety helmets				
Anchoring of safety belt to the life line rope				
ENVIRONMENT				
Lubricant waste/engine oils properly dispose.				
Waste from Canteen, offices, sanitation etc. disposed properly.				
Disposal of surplus earth, stripping materials, expired batteries, oily rags and combustible materials done properly.				
HEALTH CHECKS				
Hygienic conditions at labor camps O.K.				
Availability of first-aid facilities				
Proper sanitation at site, office & labor camps.				
Arrangement of medical facilities.				
Measures for dealing with illness.				
Availability of potable drinking water for workmen & staff.				
Provision of crèches for children.				

Signature of Subcontractor Site In-charge:

Date:

**POWER SECTOR****Format for Inspection of Illumination / Lux Levels**

FORMAT NO: HSEP:14-F21

REV NO.: 00

PAGE NO. 01 OF 1

Name of Site :	
Name of Sub-Contractor :	
Inspected by :	
Date of Inspection :	

Details of Lux Meter Used for Illumination Checking

Serial Number		Last inspection Date		Inspection Due Date	
----------------------	--	-----------------------------	--	----------------------------	--

S. No	Location	Applicable Lux Value	Measured Lux Value	Comments
1				
2				
3				
4				
5				
6				
7				
8				
9				
10				
11				
12				
13				
14				
15				

Any other checks:

--	--	--	--	--

Remarks:

Name & Sign. Of Subcontractor HSE Officer

**POWER SECTOR****Format for Incident Reporting**

FORMAT NO: HSEP:14-F22

REV NO.: 00

PAGE NO. 01 OF 2

Type of incident: Fatal/Major//Fire/Property damage (Tick what is applicable)

1	Name Of Site		3	Activity Area	
2	Scope Of Work		4	Name Of Contractor	
			5	NAME & DESIGNATION OF BHEL ACTIVITY I/C	
6	Date & Time Of Accident		7	Date Resumed	
8	No. Of Work-Days Lost by Victim (If Duty Not Resumed, Give Estimated Figure)				
9	No. Of Man-hours Lost By Others				
10	Personal Details Of Injured and/or Details Of Materials/Equipment/ Property Damaged				
Name				Name Of Material / Equipment / Property	
Period Of Employment					
Age	Yrs.	Sex	Male/Female	Estimated Cost	Actual Cost
Marital Status		Single/ Married			
Occupation				Nature Of Damage	
Part Of Body Injured					
Nature Of Injury					
Agency (Object / Equipment / Substance) Most Responsible For Causing Accident / Injury / Damage					
12	Person (Name & Designation) With Most Control Over Agency (Object / Equipment / Substance) Causing Accident Injury / Damage				
13	Describe Clearly How the Accident Occurred (Use Additional Sheet, If Required)				

**POWER SECTOR****Format for Incident Reporting**

FORMAT NO: HSEP:14-F22

REV NO.: 00

PAGE NO. 02 OF 2

Analysis

14	What Acts and/or Conditions Contributed Most Directly to This Accident	
15	What Are the Basic Reason for The Existence of These Acts and/or Condition?	
16	What Corrective Actions Have Been Taken to Prevent Accident Recurrence?	
	Date:	Signature Of Site HSE Coordinator
17	Comments of Head/Sox	
	Date:	Signature Of Head/SOX

	POWER SECTOR	FORMAT NO: HSEP:14-F30
	Format for Monthly HSE Planning & Review	REV NO.: 00 PAGE NO. 01 OF 3

Note: This is a template and can be modified in consultation with BHEL

Name of the Site		Name of the Subcontractor	
Scope of Work		Date	
PART- A: PLAN OF HSE ACTIVITIES FOR THE MONTH OF.....			PART-B: REVIEW ON
SN.	Description of HSE Activity & Formats	Plan & Targets for the month	Review
1	Availability of First Aid Box at Required Places and Inspection thereof as per Format: Fo1	Areas 1.	
2	Health check-up as per Format: Fo2	Health check-up for Nos 1. New inductees 2. Drivers & Operators 3. Workers in following high risk areas: a. ...	
3	Induction training of newly joined workers as per Format: Fo3	Minimum No. of workers:	
4	Toolbox talks (TBT) conducted before start of work as per Format: Fo4	Locations of TBTs & No. of workers 1. ...	
5	PPE usage and issue as per Format: Fo6		
6	Inspection of T&Ps as per Format: Fo7	List of T&Ps to be inspected 1.	
7	Identification & Inspection Status of T&Ps as per Format: Fo8		
8	Inspection of Cranes & Winches as per Format: Fo9	List of Cranes & Winches & Nos. 1. ...	
9	Inspection of Height Working as per Format: F10	Areas: 1. ...	
10	Inspection of Welding & Gas Cutting operations as per Format: F11	Areas: 1. ...	
11	Inspection of Electrical Installations as per Format: F12	Locations: 1. ...	
12	Inspection of Elevators (as applicable) as per Format: F13	Locations: 1. ...	
13	Inspection of Excavation as per Format: F13E	Locations: 1. ...	

	POWER SECTOR		FORMAT NO: HSEP:14-F30 REV NO.: 00 PAGE NO. 02 OF 3
Format for Monthly HSE Planning & Review			
SN.	Description of HSE Activity & Formats	Plan & Targets for the month	Review
14	Job Safety Analysis as per Format F32B	Activities: 1. ...	
15	Regular Job Specific Training (Re-training) for workers involved in hazardous activities	Topics/ Hazards & No. of workers 1. ...	
16	Mass housekeeping (HK) drive in work areas	Areas 1. ...	
17	Vertigo Test of Height workers	Minimum No. of workers:	
18	Deployment of qualified HSE Officers as per contract	Location(s) & Nos. 1. ...	
19	Deployment of qualified HSE Stewards as per contract	Location(s) & Nos. 1. ...	
20	Deployment of Safety tools & Equipment (Safety Nets, Lifelines, Fall arrestors, Man-cages, flashback arrestors, scaffolding etc.)	Tool/ Equipment & Location 1. ...	
21	Safety Walks by site in charge of agency (4 -Weekly once)	Dates:	
22	Safety walks by departmental head (8-Weekly twice)	Dates:	
23	Availability/ deployment of Safety posters/ placards/ signage at strategic locations	Locations: Nos. 1. ...	
24	Provision of clean drinking water sources for workers	Locations: Nos. 1. ...	
25	Provision of toilets for workers (separate for male & female workers)	Locations: Nos. 1. ...	
26	Rest sheds for workers during lunchtime, rain, dust storm etc.	Locations: Nos. 1. ...	
27	Availability of following in Labor colony	1. Clean drinking water 2. Toilets 3. Cleanliness & Hygiene 4. Grass cutting, 5. Fogging 6. Electrical Inspection ...	



POWER SECTOR

Format for Monthly HSE Planning & Review

FORMAT NO: HSEP:14-F30

REV NO.: 00

PAGE NO. 03 OF 3

SN.	Description of HSE Activity & Formats	Plan & Targets for the month	Review
28	Availability of dust/ waste bins at various locations	Locations: 1. ...	
29	Availability of Ambulance (individual/ joint) in each shift	Ambulance No.	
30	Availability of emergency vehicle in each shift	Emergency vehicle	
31	Deployment/ Availability of tested Fire Extinguishers	Locations & Nos. 1. ...	
32	Tree plantation	Locations & Nos. 1. ...	
33	Waste disposal & Scrap Bins	Locations 1. ...	
34	Illumination checks	Locations 1. ...	
35	Safety award function: 1. Display of good practices Award presentation	Minimum 1 per month	
36	Submission of Daily Reports as per Format No.F31A	Daily Reports (Night & Day Shifts)	

PLAN		REVIEW	
Agency Name:	BHEL Name:	Agency Name:	BHEL Name:
Sign:	Sign:	Sign:	Sign:
Date:	Date:	Date:	Date:

**POWER SECTOR****Job Safety Analysis Format**

FORMAT NO: HSEP:14-F32B

REV NO.: 00

PAGE NO. 01 OF 1

Name of the Site	
Name of the Subcontractor	
Activity, Area	

HAZARDS	PRECAUTIONS

(Name)	Submitted By (Agency HSE)		Reviewed By (BHEL Execution)		Approved By (BHEL HSE)	
(Sign)						
(Date)						

**POWER SECTOR- HQ**

FORMAT NO: HSEP:14-F33

REV NO.: 00

PAGE NO. 01 OF 3

Checklist for Evaluation of HSE Performance

SL	Parameter for Measurement	M/O	Wt	Supporting Documents
1a	Induction training for new workers conducted through audio-visual medium & documented ?	M	1	Induction Training Records
1b	Tool box talk conducted regularly as per plan, and documented?	M	1	Toolbox Talk Records
1c	Contractor in charge and safety in charge attended safety meetings?	M	2	Minutes of Meeting
1d	Whether observations in safety meetings are complied before next meeting?	M	2	-do-
1e	Preparation and submission of Monthly HSE report within stipulated time	M	1	Report submission date
1f	Preparation and submission of Incident/near-miss report and RCA Report (as applicable) within stipulated time	M	1	Incident/ Near Miss Records
1g	Carrying out Inspections and submission of Inspection reports within stipulated time	M	1	Inspection Records
1h	Regular Job Specific Training ensured for High Risk Workers (through audio-visual medium) as per plan	M	1	Training & Attendance Records
2a	Whether the contractor is registered under BOCW	M	2	BOCW Registration Certificate
2b	Availability of Qualified safety officer (1 for every 500 labour)	M	2	Safety Officer qualification & experience records
2c	Availability of Qualified safety supervisor (1 for every 100 labour)	M	2	Safety Officer qualification & experience records
2d	All the workers are provided and using safety helmets and safety shoes/gum boots	M	2	PPE Issue Records, Inspection/ non-conformity records
2e	Housekeeping done on regular basis and scrap removal at site	M	1	Housekeeping records, Inspection/ non-conformity records
2f	Usage of Goggles/Face shields and Hand gloves for gas cutter and grinders		1	PPE Issue Records, Inspection/ non-conformity records
2g	Wall openings & floor openings are guarded?		1	Inspection/ non-conformity records
2h	Adequate illumination provided in all working area?		1	Inspection/ non-conformity records
2i	Safety posters, sign boards and emergency contact numbers in all prominent location are displayed?		1	Inspection/ non-conformity records
2j	Availability of automatic reverse horns, Main horn, hook latches for Vehicles, mobile cranes, Hydras		1	Inspection/ non-conformity records
2k	Ban of carrying mobile phones to work place is implemented for workers		1	Inspection/ non-conformity records
2l	Availability of Tags & Inspection Certificates for Cranes of all capacities		1	Master T&P List with internal & external test details
2l.2	Availability of Tags & Inspection Certificates for Winches of all capacities		1	Master T&P List with internal & external test details
2l.3	Availability of Tags & Inspection Certificates, color coding for Chain pulley blocks		1	Master T&P List with internal & external test details
2l.4	Availability of Tags & Inspection Certificates for Vehicles - Trailers, Dozers, Dumpers, Excavators. Mixers etc.		1	Master T&P List with internal & external test details
2l.5	Availability of Tags & Inspection Certificates for Welding machines, grinders, Drilling machines, etc.		1	Master T&P List with internal & external test details
2l.6	Availability of Tags & Inspection Certificates, colour coding for Wire rope slings etc.		1	Master T&P List with internal & external test details
2l.7	Availability of Tags & Inspection Certificates for Batching plants		1	Master T&P List with internal & external test details

**POWER SECTOR- HQ**

FORMAT NO: HSEP:14-F33

REV NO.: 00

PAGE NO. 02 OF 3

Checklist for Evaluation of HSE Performance

SL	Parameter for Measurement	M/O	Wt	Supporting Documents
2m.1	Use of Lifting Permit as per requirement		1	Permit Records
2m.2	Use of Height Permit as per requirement		1	Permit Records
2m.3	Use of Hot Work Permit as per requirement		1	Permit Records
2m.4	Use of Excavation permit as per requirement		1	Permit Records
2m.5	Use of Confined space work permit as per requirement		1	Permit Records
2m.6	Use of Grating removal and safety net removal permit as per requirement		1	Permit Records
2m.7	Use of Lockout-Tag out permit as per requirement		1	Permit Records
2m.8	Use of Radiography permit as per requirement		1	Permit Records
2m.9	Use of Night/ Holiday Work Permit as per requirement		1	Permit Records
2m.10	Use of Any other Applicable Permit as per requirement		1	Permit Records
3a	Material safety data sheet(MSDS) available for all chemicals and displayed in usage and storage area?		1	Inspection/ non-conformity records
3b	Spillages of oil/concrete and other chemical is controlled and cleaned by proper method in case of spill?		1	Inspection/ non-conformity records
3c	Availability of adequate number of urinals in workplace and in elevations and maintained	M	1	
3d	Availability of rest rooms for workers at site	M	1	
3e	Availability of Drinking water facility at work spot		1	
3f	Hygienic Labour colony is provided for workers.		1	
4a	Is heavy/complex critical lifting permit obtained for heavy, complex materials before handling/erection activity?		1	Work Permit records
4b	Whether area below lifting activities barricaded		1	Inspection/ non-conformity records
4c	Availability of experienced rigging foreman		1	Experience details of rigging foreman
4d	Is agency is following proper storage and handling procedure as per manufacturer standard for all hazardous material?		1	Procedure for storage & handling
4e	Are oxygen and acetylene cylinders are transported to work place from storage area in trolleys		1	
5a	Whether all deep excavation has been protected by barrier		1	Inspection/ non-conformity records
5b	Sloping/benching & shoring provided for excavation as per requirement?		1	-do-
5c	Proper access and egress provided for excavations?		1	-do-
5d	Blasting is done in controlled manner?		2	-do-
6a	Whether Electrical booth is equipped with Co ₂ fire extinguishers and fire buckets filled with sand?		2	Inspection/ non-conformity records
6b	Availability of Illumination lamp in electric booth?		1	-do-
6c	whether Caution Boards have been displayed?		1	-do-
6d	Usage of Metal Plug top for all hand power tools ?		1	-do-
6e	Usage of Insulated welding cables.		1	-do-
6f	Electrical Booth/Distribution Board to be covered by proper Canopy.		1	-do-
6g	Availability of functional & individual 3oma ELCB / RCCB and MCB for protection and conducting periodical check-up?		1	-do-
6h	Double earthing for panel boards and all machinery & proper earth pit with regular inspection available?		1	-do-
6i	Whether Electrician is qualified and experienced		1	Qualification & Experience records of electrician
6j	Availability and usage of Rubber hand gloves by electrician?		1	Inspection/ non-conformity records

	POWER SECTOR- HQ	FORMAT NO: HSEP:14-F33
	Checklist for Evaluation of HSE Performance	REV NO.: 00 PAGE NO. 03 OF 3

SL	Parameter for Measurement	M/ O	Wt	Supporting Documents
7a	Whether Scaffolding pipes made with steel or aluminum, are being used and checked periodically by experienced/ certified scaffolder?		2	Inspection/ non-conformity records
7b	8mm Stainless Steel wire rope with plastic cladding is provided for life line (Vertical / Horizontal) during height work?		2	-do-
7c	Availability of emergency lighting in case of power failure		1	-do-
7d	Whether all the openings are covered with Safety Nets made of fire proof Nylon?		1	-do-
7e	Whether MS pipe rails around staircases & platforms in usage are provided with top, middle rails and toe guard ?		1	-do-
7f	Whether Ladder with vertical life line /Fall arrestor is available to climb?		1	-do-
7g	Whether all workers deployed for working at height have been issued height pass after undergoing vertigo test?		1	Height Pass records
7h	Whether all workers deployed for height work / climbing ladder are provided and using Double lanyard safety belt?		1	PPE Issue records, inspection/ non-conformity reports
7i	Is all hand tools/Small material used by height workers is tied firmly to prevent fall?		1	-do-
8a	Flash back arrestors for all gas cutting sets is available on Torch side and cylinder side		1	Inspection/ non-conformity records
8b	Oxygen/Acetylene/LPG cylinders not in use have caps in place and stored separately?		1	-do-
8c	Availability of Face screen, Hand gloves, and Apron, for welders		1	-do-
8d	Protection from falling hot molten metal during metal cutting / welding at height by providing GI sheet below the cutting area especially in fire prone areas		1	-do-
9a	Pre-employment medical check-up done for all workers and submitted?		1	Medical check records
9b	Availability of first aid center, with MBBS doctor(Own or Sharing basis)	M	2	Attendance records
9c	Availability of Ambulance facility 24 hours (Own or sharing basis)	M	2	-do-
9d	Is First aid trained personnel's are available and their names are displayed at site?	M	1	-do-
9e	Availability of Emergency vehicle at site		1	
9f	Periodical medical check-up is conducted for all the workers and submitted?		1	Medical check records
9g	Availability of sufficient number of first aid box as per standard list and maintaining record		1	Inspection records
10a	Availability of Fire extinguishers, buckets at all vulnerable points		2	Fire extinguisher records
10b	Periodic fire mock drill conducted?		1	Fire, Mock drill records
10c	Are all flammable materials are stored separately?		1	
10d	Periodic grass cutting is done in material storage area?		1	
10e	Availability of 24V DC lighting in confined space work area		1	
10f	Availability of exhaust fan in confined space work area		1	

Note:

- **M: Mandatory; O: Optional.** Points other than mandatory can be excluded with appropriate justification (scope etc.) by BHEL
- Additionally: 30 Marks for each Fatal Accident and 10 mark for each major accident shall be deducted.

SECTION-B

Special Requirements

 POWER SECTOR	HEALTH, SAFETY AND ENVIRONMENT PLAN FOR SITE OPERATIONS (SECTION-B)	Doc. No.: HSEP:14-ER Rev.: 01
		Date: 08.05.20
		Page 153 of 170

1. Establishment of Common Facilities for whole Project – cost to be borne in full by subcontractor.

Table 1.1

S. No.	Item	Details as per Clause No. of this Section	Applicable / Not Applicable with Remarks	Package
1	Construction of Medical Centre	a	Applicable	Civil
2	Construction of Worker Training Centre (A part of safety park)	b	Applicable	Civil
3	Construction of Vertigo Test Structure (A part of safety park)	c	Applicable	Civil
4	Deployment of Specialists	d	Applicable	By concerned agencies
5	HSE Equipment	e	Applicable	By concerned agencies
6	HSE measurement devices	f	Applicable	By concerned agencies
7	Urinals in under-construction structures	g	Applicable	By concerned agencies
8	Safety Park	h	Applicable	Civil

Note: Construction of Safety Park with allied infrastructure, is only applicable in those new projects of BHEL-PSER, where there is no established safety park.

a. MEDICAL CENTRE

- i. A medical center shall be setup at site with basic facilities for handling medical emergencies
- ii. Deployment of Medical Professional:
 - 1. A qualified medical professional shall be deployed at site at all times.**
 - 2. When total employee & worker strength at site crosses 500, medical professional with MBBS Degree from recognized institute shall necessarily be deployed**
- iii. Ambulance shall be deployed along with a trained driver and accessories as per Schedule V of BOCW Central Rules, 1998. Ambulance shall be utilized exclusively for transporting the accident victim. Ambulance drivers shall be regularly trained in First Aid.
- iv. Non deployment of Ambulance and First Aider as above shall invite a penalty of Rs. 30000 pm and Rs10000 PM respectively
- v. Medical waste shall be disposed as per prevailing legislation (Bio-Medical Waste – Management and Handling Rules, 1998).
- vi. Above are bare minimum requirements. Any legal requirements over and above these specifications shall supersede the above requirements



POWER
SECTOR

HEALTH, SAFETY AND ENVIRONMENT PLAN
HEALTH, SAFETY AND ENVIRONMENT PLAN
FOR
SITE OPERATIONS
(SECTION-B)

Doc. No.: HSEP:14-ER

Rev.: 01

Date: 08.05.20

Page 153 of 170

b. WORKER TRAINING CENTRE

- i. Indoor Worker Training Center to be developed at site with seating capacity of at least 50 trainees
- ii. Projector with following minimum specifications:

Native Resolution	XGA, 1024x768
Brightness (ANSI lumens)	3300
Contrast Ratio	13000:1
Display Color	30 Bits
Aspect Ratio	4:3

- iii. A Laptop or Desktop PC with following minimum specifications:

Processor	Intel Celeron Dual Core
Memory (RAM)	2 GB
Graphics Card	2GB Video Memory
Hard Disk Capacity	60 GB
Monitor Size	14 inches
Keyboard	
Mouse	

- iv. Stereo speakers with minimum 50W RMS sound output
- v. PA system for Addressing Workers
- vi. Seating arrangement

c. Development of Vertigo Test Structure:

Vertigo test Structure to be developed as per **Annexure 04**

d. Specialists:

Following specialists shall be deployed by the subcontractor, who shall cater to whole project as per BHEL requirements / instructions

- I. **Qualified T&P Inspector: subcontractor** shall engage one qualified T&P inspector having undergone a certification course in the discipline.
- II. **Qualified Scaffolding Erector and Inspector:** Subcontractor shall deploy one qualified Scaffolding Supervisor and Inspector having undergone a certification course in the discipline



**POWER
SECTOR**

**HEALTH, SAFETY AND ENVIRONMENT PLAN
FOR
SITE OPERATIONS
(SECTION-B)**

Doc. No.: HSEP:14-ER

Rev.: 01

Date: 08.05.20

Page 155 of 170

- e. **Tools & Equipment:** Following equipment conforming to relevant IS Codes for the job shall be ensured by subcontractor:

S. No.	Item
1	Lifelines
2	Retractable Fall Arrestors
3	Safety Nets (10m X 5m)
4	Sky Climbers
5	Fire Blanket
6	Honey Bee Removal Suit & Kit
7	Flashback Arrestors
8	Barricading Tape
9	Binoculars
10	Walkie-Talkies
11	LOTO kit
12	24-Volt light
13	Sand Buckets
14	Hard barricading planks
15	Standby Fire kits

S. No.	Item	Type of Job / Purpose	Remarks
1	Lifelines (Steel Rope) and posts	Height work	
2	Retractable Fall Arrestors	Height Work	
3	Safety Nets (for fall protection; railings also to be covered)	Height Work	
4	Sky Climbers	Height Work	
5	Fire Blanket, Spark/ slag collector	Hot Work	
6	Honey Bee Removal Suit & Kit	General	
7	Flashback Arrestors	Hot work	
8	Barricading –Hard (Scaffolding Pipes & Clamps or fabricated using structural/round	Height Work, Excavation, General Barricading	
9	Binoculars	HSE Inspection	
10	Walkie-Talkies	Lifting	
11	LOTO kit	Working on charged line	
12	24-Volt light	Confined Space/ temp work	
13	Sand and Water Buckets	Hot work/Electrical work	
15	Standby Fire kits Fire extinguisher stands	Hot work/Electrical work	



**POWER
SECTOR**

**HEALTH, SAFETY AND ENVIRONMENT PLAN
FOR
SITE OPERATIONS
(SECTION-B)**

Doc. No.: HSEP:14-ER

Rev.: 01

Date: 08.05.20

Page 156 of 170

Above equipment are bare minimum to be essentially maintained at all times. Additional numbers to be deployed as and when required in order to ensure fulfillment of all Safety requirements

f. HSE Measurement Equipment & Tools

S. No	Device
1	ELCB Tester
2	Multi meter (Light cables)
3	Earth Resistance Meter
4	Lux Meter
5	Decibel Meter
6	Anemometer
7	Breath Analyzer (Alcohol)
8	Multi-gas analyzer
9	Gas leakage detector / alarm
10	Gas monitor (confined space)
11	Radiation meter & Badges
12	Blood pressure monitor
13	Fire detectors
14	Dust Particle Detector

g. Urinals in Under-construction structures:

Urinals for in under-construction structures for easy access eg. In case of Boiler elevations etc.

2. Shared Facilities – where part of operating cost is borne by subcontractor in proportion to contract value

The subcontractor shall bear running expenses of above facilities on a 'proportional to contract value sharing basis as finalized by BHEL.

S. No.	Facility
1.	Operation of Ambulance, Nurses, Medical Consumables
2.	Construction, Maintenance & Upkeep of Latrines and Urinals in Common spaces
3.	Drinking Water Provision in Common Spaces
4.	Dust Control / Water Sprinkling, Pest Control, Fumigation at Site



**POWER
SECTOR**

**HEALTH, SAFETY AND ENVIRONMENT PLAN
FOR
SITE OPERATIONS
(SECTION-B)**

Doc. No.: HSEP:14-ER

Rev.: 01

Date: 08.05.20

Page 157 of 170

LIST OF REFERENCES

S. No	Code Name	Title
1	IS: 818-1888 (Reaffirmed 2003)	Code of Practice for Safety and Health requirements in Electric and Gas Welding and Cutting operations.
2	IS: 1179-1967 (Reaffirmed 2003)	Specification for Equipment for Eye & Face protection during welding.
3	IS: 1989 (Part 2):1986 (Reaffirmed 1997)	Specification for Leather Safety Boots & Shoes
4	IS:2925 – 1984 (Reaffirmed 2010)	Specification for Industrial Safety Helmets
5	IS:3521: 1999 (Reaffirmed 2002)	Industrial Safety Belts & Harnesses-Specification
6	IS:3646(Part II) – 1966(Reaffirmed 2003)	Code of Practice for Interior Illumination
7	IS:3696 (Part I) – 1987 (Reaffirmed 2002)	Safety Code for Scaffolds and Ladders
8	IS: 3696(Part 2) : 1991 (Reaffirmed 2002)	Scaffolds and Ladders-Code of Safety
9	IS: 3764:1992	Excavation Work – Code of Safety
10	IS:3786 – 1983 (Reaffirmed 2002)	Method for Computation of Frequency and Severity Rates for Industrial Injuries and Classification of Industrial Accidents
11	IS.4014.2.1967	Steel tubular Scaffolding
12	IS:4770: 1991 (Reaffirmed 2006)	Rubber Gloves Specification (Electricals Purposes)
13	IS:4912: 1978 (Reaffirmed 2002)	Safety Requirements for Floor and Wall Openings, Railings and Toe Boards
14	IS: 5557 – 1969	Industrial and Safety rubber knee boots.
15	IS: 5983 – 1980 (Reaffirmed 2002)	Specification for Eye-Protectors
16	IS:6519 – 1971 (Reaffirmed 1997)	Code of Practice for Selection, Care and Repair of Safety Footwear
17	IS.6549.1972	Glossary of terms used for Lifting tackles
18	IS:6994(Part I)-1973 (Re affirmed 1996)	Specification for Industrial Safety Gloves Leather and Cotton Gloves
19	IS.7215.1974	Steel Structure Fabrication
20	IS.7969.1975	Handling and storage of building material



**POWER
SECTOR**

**HEALTH, SAFETY AND ENVIRONMENT PLAN
FOR
SITE OPERATIONS
(SECTION-B)**

Doc. No.: HSEP:14-ER
Rev.: 01
Date: 08.05.20
Page 158 of 170

21	IS:8519 – 1977 (Reaffirmed 1983)	Guide for Selection of Industrial Safety Equipment for Body Protection.
22	IS:8520 – 1977 (Reaffirmed 2002)	Guide for Selection of Industrial Safety Equipment for Eye, Face and Ear Protection.
23	IS:9167:1979	Specification for Ear-Protectors
24	IS:9473:2002	Respiratory Protective Devices-Filtering Half Masks to protect against Particles-Specification.
25	IS: 9944:1992 (Reaffirmed 2003)	Natural and Man-made Fiber Rope Slings- Recommendations on Safe working loads.
26	IS 11006 : 2011	Flash Back(Flame) Arrestor Specification
27	IS: 11226 – 1985	Leather Safety footwear having direct molding sole.
28	IS:11057 – 1884 (Reaffirmed 2001)	Specification for Industrial Safety Nets
29	IS: 12254:1993 (Reaffirmed 2002)	Polyvinyl Chloride (PVC) Industrial Boots Specification
30	IS:13367(Part 1):1992 (Reaffirmed 2003)	Safe Use of Cranes-Code of Practice
31	IS: 14166:1994 (Reaffirmed 2002)	Respiratory Protective Devices-Full Face Masks Specification
32	IS:14746: 1999 (Reaffirmed 2003)	Respiratory Protective Devices-Half Masks and Quarter Masks - Specification
33	IS: 15397 :2003 (Reaffirmed 2008)	Portable Extinguisher Mechanical Foam Type(Stored Pressure)-Specification
34	IS: 19011:2002	Guidelines for Quality and/or Environmental Management Systems Auditing

 <p>POWER SECTOR</p>	HEALTH, SAFETY AND ENVIRONMENT PLAN FOR SITE OPERATIONS (SECTION-B)	Doc. No.: HSEP:14
		Rev.: 01
		Date:
		Page 159 of 170

As per Contract Labor (Regulation & Abolition Act), Central Rules, 1971,

(1) The first-aid box shall be distinctively marked with a Red Cross on a white background and shall contain the following items, namely:

(a) For establishments in which the number of contract laborers employed does not exceed fifty, each first aid box shall contain the following equipment:

(i)	6 small sterilized dressings
(ii)	3 medium size sterilized dressings
(iii)	3 large size sterilized dressings
(iv)	6 pieces of sterilized eye pads in separate sealed packets.
(v)	6 roller bandages 10 cm wide.
(vi)	6 roller bandages 5 cm wide.
(vii)	One tourniquet
(viii)	A supply of suitable splints
(ix)	Three packets of safety pins.
(x)	Kidney tray.
(xi)	3 large sterilized burn dressings.
(xii)	1 (30ml) bottle containing a two percent alcoholic solution of iodine
(xiii)	1 (30 ml) bottle containing Sal volatile having the dose and mode of administration indicated on the label
(xiv)	1 snake bite lancet
(xv)	1 (30gms) bottle of potassium permanganate crystals.
(xvi)	1 pair scissors
(xvii)	1 copy of the First-Aid leaflet issued by the Director General, Factory Advice Service and Labor Institutes, Government of India.
(xviii)	A bottle containing 100 tablets (each of 5 grains) of aspirin
(xix)	Ointment for burns
(xx)	A bottle of suitable surgical anti-septic solution



HSEP:14 - ANNEXURE 03

Details and Contents of First Aid Box

(b) For establishment in which the number of contract laborers exceeds fifty each first-aid box shall contain the following equipment:

(i)	12 small sterilized dressings
(ii)	6 medium size sterilized dressings
(iii)	6 large size sterilized dressings.
(iv)	6 large size sterilized burn dressings
(v)	6 (15 grams) packets sterilized cotton wool
(vi)	12 pieces of sterilized eye pads in separate sealed packets.
(vii)	12 roller bandages 10 cm wide.
(viii)	12 roller bandages 5 cm wide.
(ix)	One tourniquet.
(x)	A supply of suitable splints.
(xi)	Three packets of safety pins.
(xii)	Kidney tray.
(xiii)	Sufficient number of eye washes bottles filled with distilled water or suitable liquid clearly indicated by a distinctive sign which shall be visible at all times.
(xiv)	4 per cent Xylocaine eye drops, and boric acid eye drops and soda by carbonate eye drops.
(xv)	1 (60ml) bottle containing a two percent alcoholic solution of iodine
(xvi)	One (two hundred ml) bottle of mercurochrome (2 per cent) solution in water.
(xvii)	1 (120ml) bottle containing Sal volatile having the dose and mode of administration indicated on the label.
(xviii)	1 roll of adhesive plaster (6 cmX1 meter)
(xix)	2 rolls of adhesive plaster (2 cmX1 meter)
(xx)	A snake bite lancet.
(xxi)	1 (30 grams) bottle of potassium permanganate crystals.
(xxii)	1 pair scissors
(xxiii)	1 copy of the First-Aid leaflet issued by the Director-General, Factory Advice service and labor Institutes, Government of India.
(xxiv)	a bottle containing 100 tablets (each of 5 grains) of aspirin
(xxv)	Ointment for burns
(xxvi)	A bottle of a suitable surgical anti septic solution.

(2) Adequate arrangement shall be made for immediate recoument of the equipment when necessary.

 <p>POWER SECTOR</p>	HEALTH, SAFETY AND ENVIRONMENT PLAN FOR SITE OPERATIONS (SECTION-B)	Doc. No.: HSEP:14
		Rev.: 01
		Date:
		Page 161 of 170

Table 1

S. No.	Topic
1	Vertigo / Height working Test Structure Layout
2, 3	Structure Layout Sketch
3	Actual Photo of a typical structure
4	Bill of Materials
5	Guidelines for Conducting the Test

**Note:**

- All dimensions are in mm
- Drawing is not to scale
- Inside boundary area to be filled with sand to level with road (external)
- Details of F1 and F2 are shown below

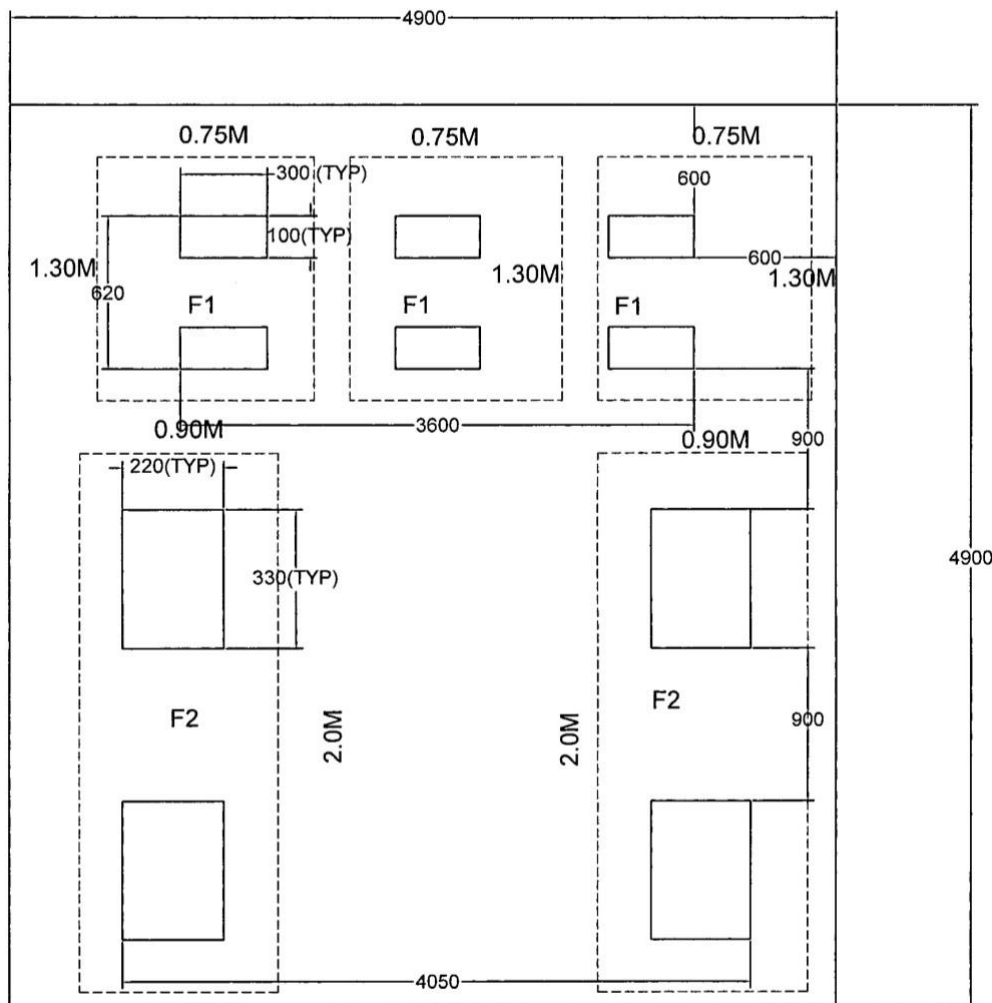
Figure 1: Vertigo / Height Work Test Structure Layout



HSEP:14 - ANNEXURE 04

Vertigo Test Structure Specifications

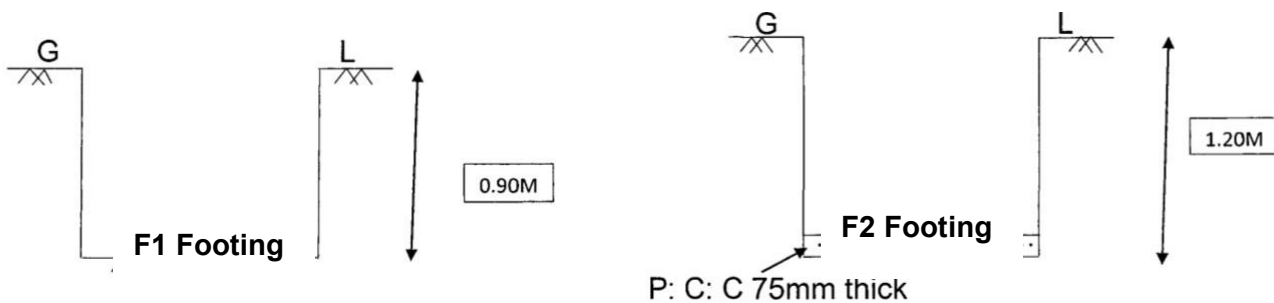

Note:

- Concrete Grade is M15
- Drawing is not to scale
- TOC is at Road Level
- G L refers to Ground Level

Figure 2



HSEP:14 - ANNEXURE 04

Vertigo Test Structure Specifications

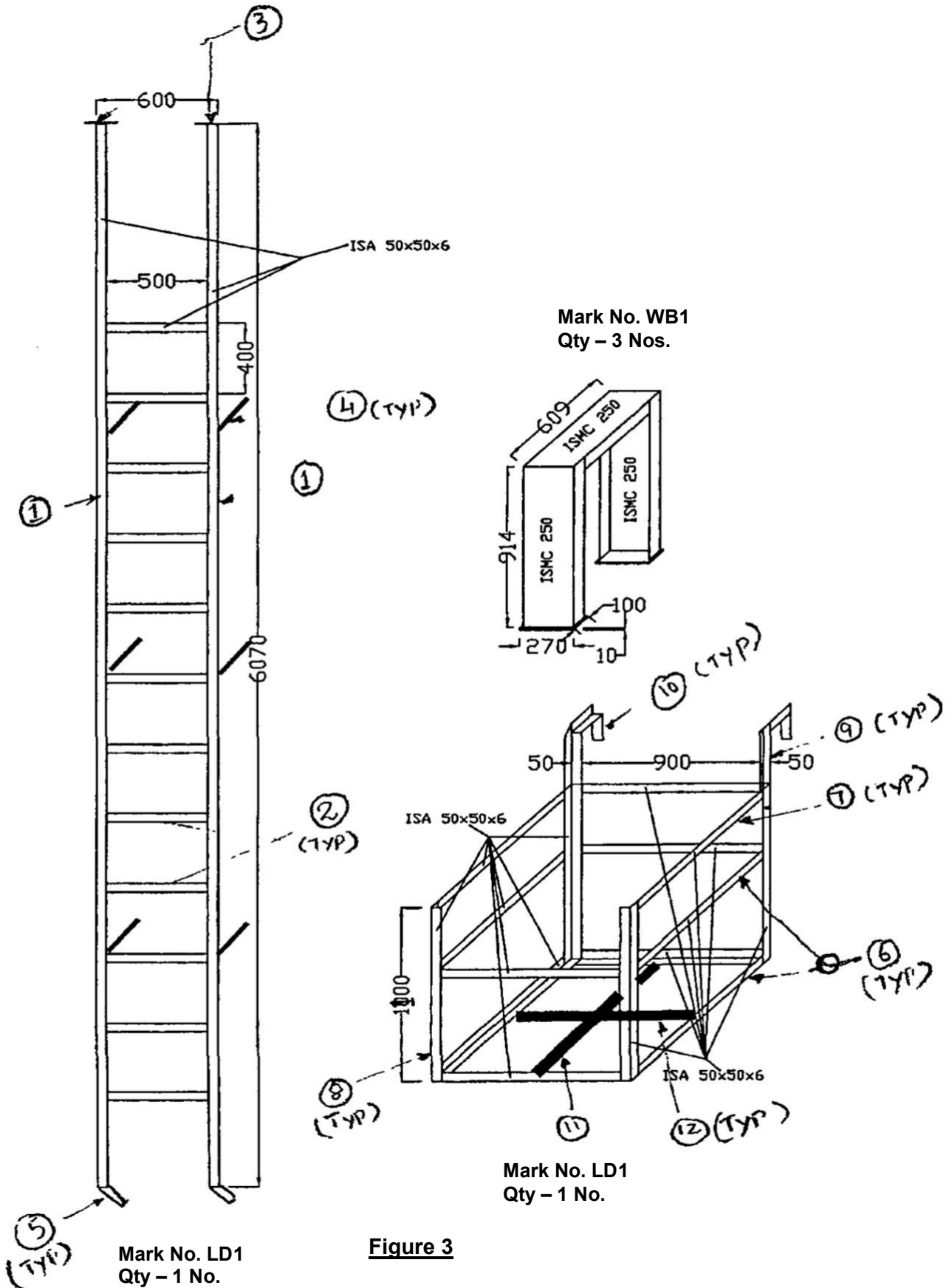

Figure 3



HSEP:14 - ANNEXURE 04

Vertigo Test Structure Specifications

Figure 4

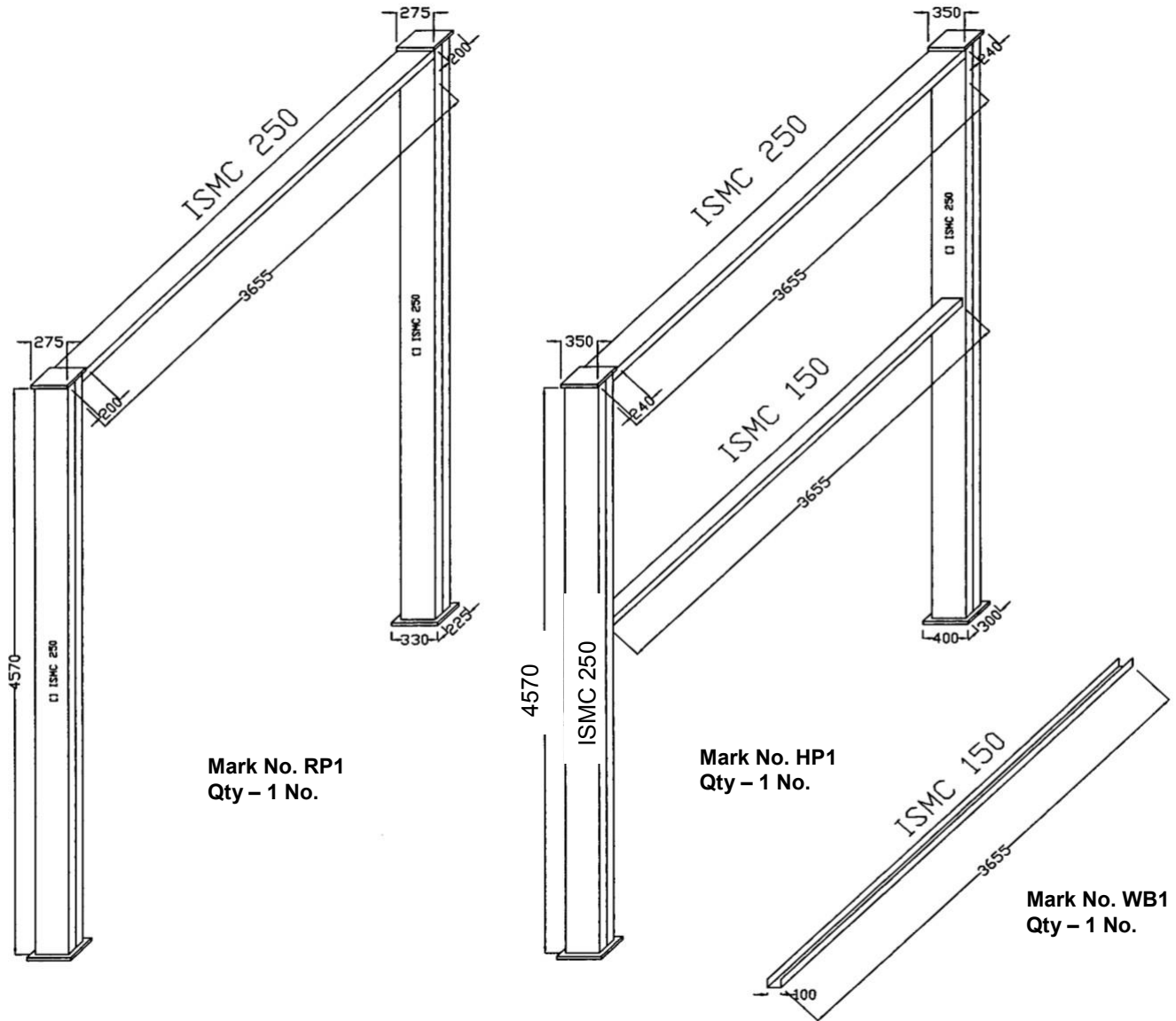

Pic-1: Actual Photo of a Typical Vertigo Test

**HSEP:14 - ANNEXURE 04****Vertigo Test Structure Specifications**

Page 5 of 6

Table 2: BOM FOR HEIGHT WORK INDUCTION TRAINING MODULE

Sl. No.	Description	Width (mm)	Length (mm)	Qty (No's)	Unit Wt (Kgs)	Total Wt. (Kgs)
MKD NO. WB1						
1	ISMC250		609	3	34.20	62.483
2	ISMC250		914	6	34.20	187.553
3	ISMC100		3655	1	9.56	34.942
4	PL10	100	270	6	78.50	12.717
			Total Weight (Kgs)			297.695
MKD NO. RP1						
1	ISMC250		4570	4	34.20	625.176
2	ISMC250		3655	1	34.20	125.001
3	PL25	225	330	2	196.25	29.143
4	PL25	200	275	2	196.25	21.588
			Total Weight (Kgs)			800.908
MKD NO. HP1						
1	ISMC250		4570	4	34.20	625.176
2	ISMC250		3655	1	34.20	125.001
3	ISMC150		3655	1	16.80	61.404
4	PL25	300	400	2	196.25	47.100
5	PL25	240	350	2	196.25	32.970
			Total Weight (Kgs)			891.651
MKD NO. LD1						
1	ISA50X50X6		6070	2	4.50	54.630
2	ISA50X50X6		500	12	4.50	27.000
3	PL12	75	75	2	94.20	1.060
4	ISA50X50X6		300	6	4.50	8.100
5	ISA50X50X6		255	2	4.50	2.295
6	ISA50X50X6		1000	8	4.50	36.000
7	ISA50X50X6		910	3	4.50	12.285
8	ISA50X50X6		1100	4	4.50	19.800
9	ISA50X50X6		650	2	4.50	5.850
10	ISA50X50X6		350	2	4.50	3.150
11	PL8	75	900	1	62.80	4.239
12	PL8	75	410	2	62.80	3.862
			Weight (Kgs)			178.271
			Total Weight (Kgs)			2168.525



HSEP:14 - ANNEXURE 04

Vertigo Test Structure Specifications

Page 6 of 6

A. Test Procedure / Guidelines

Fear of height may be physiological or psychological. Therefore, to rule out any possibility of physiological factor, detailed medical check-up of workers is carried out before vertigo test. Medical check-up of workers includes the following:

history of past illnesses (like epilepsy, drug allergy, diabetics/ hypertension, unconsciousness etc.), general physical examination (like height, weight, BMI, build and nourishment etc.), measurement of pulse rate, Blood Pressure, respiratory rate.

After this check-up, those who are found suitable for height work by examining doctor, are allowed to undergo vertigo test.

During this health check-up, psychology of workers is also studied. If any worker finds it extremely difficult/ frightening to climb the monkey ladder & walk on the beam, during/after performing vertigo test or even before performing, then he is treated as disqualified.

As per standard, during vertigo test, worker is allowed to climb on a foundation through monkey ladder, walk on a beam, then steps down at the other end of beam, through monkey ladder. Height of the beam should be at least six feet from ground level. All necessary safety precautions are taken during this test. Worker has to wear full body harness with double lanyard. A horizontal lifeline is run parallel to the beam and worker has to put his lanyards into the lifeline. Additionally, a safety net is also put below the beam for rescue of the victim in case of a fall from beam.

Following activities are generally carried during testing:

1. Walking Bench Training:

- a. Person should walk over the channel. He should maintain balance & walk without much problem.
- b. If the person has problem to balances himself on repeated chances, he may be having flat foot or some other problem. So, he may not be fit for height work.

2. Rope Climb Training:

Person should be able to climb the rope up to the top channel for ensuring that in case of fall, a person hanging on the safety harness, will be able to safely climb back to the platform within minimum time period before the safety harness start breaking down under the load.

3. Height Work Training:

Person should walk freely on the middle channel while holding the top channel with the help of safety harness.

4. Ladder for Vertical fall arrestor Training:

Vertical fall arrestor rope is fixed from top to bottom of the ladder. It will ensure:

- Usage of vertical fall arrestor.
- Usage of two lanyards of a safety harness.
- Ensure 3-point contact on the ladder while climb.

5. Chair for work at height Training:

- Climb though vertical ladder with two lanyard ropes.
- Hooking of two lanyard ropes to life line. With this safe arrangement, he can walk to chair.
- Sits in the chair safely, comes out & walks back to the vertical ladder & come down from vertical ladder. After completion of vertigo test, blood pressure of worker is again measured. If it is not within acceptable limits for any worker, concerned worker is denied height pass.

Only those who pass the above training are fit for height work.

 <p>POWER SECTOR</p>	HEALTH, SAFETY AND ENVIRONMENT PLAN FOR SITE OPERATIONS (SECTION-B)	Doc. No.: HSEP:14
		Rev.: 01
		Date: Page 167 of 170

Safety Park Requirements

Sl. No.	Training room (capacity 40 persons)	Qty.
1	Class room chair	25
2	Office Table	3
3	Rolling chair	3
4	Almirah	1
5	Visitor chair	10
6	Drawer	2
7	Single bed	1
8	Mattress	1
9	Projector	1
10	Projector screen	1
11	Sound speakers	1
12	Desktop Computer	3
13	Printer	1
14	White Board	1
15	Marker	5
16	Duster	1
17	Door Mat	9
18	Dustbin (Small + BIG)	7+1
19	Mannequin	1
20	Helmet	1
21	Face Shield	1
22	Safety Goggle	1
23	Welding shield	1
24	Ear Muff	1
25	Ear Plug	1
26	Nose Mask	1
27	Breathing Apparatus	1
28	Hand Gloves (Cotton)	1
29	Hand Gloves for Electrician (Rubber)	1
30	Hand gloves Rubber	1
31	Hand Gloves Lather	1
32	Construction Safety Uniform (Boiler Suit)	1
33	Welding Apron	1
34	Safety Shoes	1
35	Leg Guard for Welder	1
36	Poster for Occupational Disease like Pneumoconosis, silicosis etc.	1

37	Gum Boot	1
38	Full Body Harness	1
39	8 MM Wire rope for life line. Length 20 Feet (FT).	1
40	Safety Net for man & materials. Size 15 FT X 15FT.	1
41	Monkey ladder 15 FT.	1
45	Fire Extinguisher All types(DCP,CO2 & Foam)	1
46	Bed Sheet	1
47	Pillow	1
48	Curtain	12
49	curtain fittings	12
50	AC (1.5 TON)	3
51	AC (2 TON)	2
52	Rope pully.	1
53	PP Rope for pully 20 MTR.	
54	Ladder Clamps	6
55	Aluminum ladder 6 MTR.	1
56	Carry Bag	
57	Scaffolding all Materials for 5 Mtr. Height like Scaffolding tubes, Sole plate, base plate, Right angle clamps, Swivel clamps, beam clamps, Joint box/joint pin, toe guard/board,	

RECORD OF REVISION

Clause No.	Rev. No.	Brief Description of Revision	Date
All	00	New Procedure Introduced	25.04.2019
All	01	OCPs-60, 61& 62 introduced, New formats introduced	08.05.2020



Health, Safety & Environment, Power Sector Headquarters

Bharat Heavy Electricals Limited

Regd. Office: BHEL House, Siri Fort, New Delhi – 110049, India

Website: www.bhel.com

	<h2>OPERATIONAL CONTROL PROCEDURE</h2>	Doc. No.: HSEOCP: 61 Rev. No.: 01 Rev. Date: 01.06.2020 Page 1 of 13		
OCP No. : 61	Resumption of Construction Activities After Lock Down and Prevention of Coronavirus Infection during Site Operations			
Purpose	<ul style="list-style-type: none"> ➤ To resume work in a safe manner after Lock down due to COVID-19 Outbreak ➤ To ensure health & safety of personnel and prevention of infection during operations ➤ To ensure HSE Management & Control during operations 	<table border="1" style="width: 100%;"> <tr> <td style="width: 20%;">Scope</td> <td>PS Regions</td> </tr> </table>	Scope	PS Regions
Scope	PS Regions			
Background	<ul style="list-style-type: none"> ➤ The purpose of this procedure is to resume construction works at BHEL project sites in the event of 'Construction activities' being permitted by the Government/District Administration/Statutory Authorities. ➤ By following this OCP the chain of corona spread will largely be contained and works can be done safely. ➤ All precautionary measures are to be ensured at site and labor colonies so that the labor force feels safe and secure at work place and act in a productive manner. ➤ This OCP also lays down guidelines to handle cases of infection 			
Applicability	<ul style="list-style-type: none"> ➤ This OCP applies to all BHEL employees and its subcontractors working at project sites. ➤ It also covers guidelines for medical personnel, security personnel, visitors and others 			
Responsibility	Concerned Site In-charge / Site HSE Head/Package Head			
Performance Criteria	Number of cases of violations from these guidelines. All violations must be recorded and compliance for the same immediately/ within day			
References	<ul style="list-style-type: none"> ➤ Corporate HSE Circular BHEL:CO: SOP: COVID-19 : 01 ➤ Corporate Guidelines regarding disinfection for Prevention of COVID-19 in BHEL Offices, Townships, Hospitals, Factories and other common places (No. AA:HR:MR 1 (C) dated 20-03-2020) ➤ OHSAS : 18001 , ISO : 14001:2015, ISO 45001:2018 ➤ ICMR & WHO Guidelines for COVID 19 ➤ Govt. of India Guidelines being issued from time to time ➤ Guidelines issued by National Centre for Disease Control and other agencies of Govt. of India ➤ WHO Guidelines being issued from time to time 			

Prepared by	Reviewed by	Approved By
Task Force: Rohit Kumar, SM/ PSHQ-HSE Nitesh K. Meena, DM/ PSNR-HSE Saswajeet Raut, SE/PSER-HSE Navin Sadh, SE/ PSWR-HSE Sandeep Dalal, SE/ PSSR-HSE	HSE Heads/ PS-Regions: S. C. Meena, AGM/ PSNR B Tirkey, AGM/ PSER R. O. Jadhao, AGM/ PSWR Mukesh Shrivastava, AGM/ PSSR	Head/ HSE, PSHQ: Santosh Nair, GM



OPERATIONAL CONTROL PROCEDURE

Doc. No.: HSEOCP: 61

Rev. No.: 01

Rev. Date: 01.06.2020

Page 2 of 13

OCP No. : 61







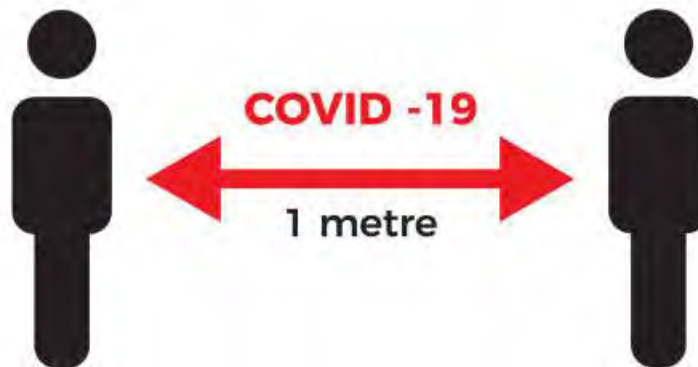

Resumption of Construction Activities After Lock Down and Prevention of Coronavirus Infection during Site Operations

General PPEs & Precautions

Maintain Social Distance of at least 1 meter **Minimum (more the better)**

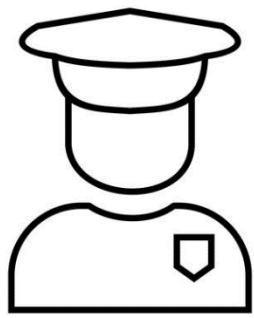

Precautions at all times is necessary. Even a single lapse can lead to infection

	Face shield/ mask must be worn by all at all times and disposed/ cleaned properly		Protective clothing must be worn		Protective gloves as identified in Safety Data Sheet
	Appropriate footwear with substantial uppers must be worn		Mandatory requirements are specified and must be followed. Report any accidents.		
	Spray to disinfect personal items/ areas		Spray to disinfect public places/ infrastructures/ tools etc.	Strictly No Shaking Hands	
	Hazmat suits and special PPEs for medical personnel and other officials with more probability of coming into contact with infected		Strict security & control at Gate to avoid entry into site/office premises of infected persons and persons without necessary PPEs, unauthorized personnel, animals etc.		

	<h2>OPERATIONAL CONTROL PROCEDURE</h2>	Doc. No.: HSEOCP: 61
		Rev. No.: 01 Rev. Date: 01.06.2020 Page 3 of 13
OCP No. : 61	Resumption of Construction Activities After Lock Down and Prevention of Coronavirus Infection during Site Operations	

General

1. This procedure is applicable for all personnel working at Project Site, including staff, workers, officials, medical and security personnel, cleaners, housekeeping staff etc. It also includes visitors including drivers, cleaners, doctors, nurses, etc. entering the site premises
2. These are broad guidelines that may be followed in order to ensure the purpose of this OCP is met.
3. The procedure refers specifically to COVID-19 disease caused by SARS-CoV-2 Virus, but is applicable to similar highly infectious respiratory illnesses as well
4. This procedure is branches out of Corporate HSE Circular **BHEL: CO: SOP: COVID-19: 01 – ‘Standard Operation Procedure for Work Resumption after Lockdown’**. In case of any ambiguity & duplicity, Corporate HSE Circular & Guidelines and **Govt. guidelines** to be followed
5. This procedure is necessary to ensure continuation of business operations in order to avoid mandatory lockdown due to an infection. All precautions to be taken seriously due to the contagiousness and mortality rate of this disease. Even a slight lapse can lead to infections and shut down of site operations for the mandatory notified period
6. The physical distancing guidelines of minimum 1 m indicated in this document to be reviewed in line with latest Govt. guidelines and ensured appropriately

Detailed Procedures & Controls are given below

Procedures and Controls		
S No	Activity	Responsibility
1	<p style="text-align: center;"><u>Deployment/ Nomination of COVID Marshall</u></p> <p>a. BHEL and Agencies shall nominate COVID Marshalls, who will be responsible for monitoring the COVID prevention measures and apprising management on the same.</p> <p>b. Every agency shall nominate COVID Marshall, who shall report to BHEL COVID Marshall</p> <p>c. BHEL COVID Marshall shall be nominated by Site In-charge in consultation with Site HSE Head.</p> <p>d. BHEL COVID Marshall shall be the Nodal COVID Marshall for the site, and having overall responsibility.</p>	Agency, BHEL
2	<p style="text-align: center;"><u>Directions for Newly Joining Workers/ Officials</u></p> <p>a. Mandatory health check-up for every worker/ official joining the site</p> <p>b. An undertaking to be submitted by every worker/ official which shall specify if he/she had been in contact with a Covid-19 positive case, and other health-related details (as per Format HSEOCP61-F01)</p> <p>c. All newly joining workers/ officials, shall follow the applicable procedures/ guidelines as laid out by Govt./ statutory authorities pertaining to quarantine, prior to joining work</p>	Agency, BHEL
3	<p style="text-align: center;"><u>Routine HSE Management Activities During COVID-19</u></p> <p>a. Due to the stress on existing medical facilities due to COVID-19 pandemic, it is imperative to take utmost precautions and avoid any incidents during operations.</p> <p>b. All activities to be carried out in safest manner possible with all necessary precautions.</p> <p>c. All activities to be carried out using least amount of paperwork and physical proximity as far as possible. The methodology to issue Permit etc. can be decided by Site Management. All necessary precautions before starting activity to be ensured and regularly monitored by concerned execution and HSE Team.</p>	Agency, BHEL



OPERATIONAL CONTROL PROCEDURE

Doc. No.: HSEOCP: 61

Rev. No.: 01

Rev. Date: 01.06.2020

Page 4 of 13

OCP No. : 61

Resumption of Construction Activities After Lock Down and Prevention of Coronavirus Infection during Site Operations

	<p>d. As far as possible, meetings & classroom trainings to be avoided. Essential meetings can be carried out by following the relevant guidelines</p> <p>e. HSE Observer App to be used to monitor HSE Activities and follow up with agencies for closure of non-conformities. Follow up can also be carried out through Phone/ Video Call etc.</p> <p>f. Apart from monitoring of HSE requirements, monitoring of COVID-19 precautions by workers and BHEL and Agency Officials also to be carried out</p>	
4	<p style="text-align: center;"><u>Strict Control at Gates</u></p> <p>a. Strict Control at the Gate/ Banning Entry to Anyone Not Wearing Masks</p> <p>i. Security personnel at the gate may erect a barricade preferably approx. 10 meters from the gate and only allow personnel who are wearing proper masks inside.</p> <p>ii. Public address system may be used to warn any non-compliant visitors</p> <p>iii. Near entry gate, round markers at minimum 1-meter distance to be ensured so that distancing is ensured</p> <p>iv. A hand-wash or hand sanitiser facility is preferable at the gate to allow entry after hand wash or hand sanitisation. These are also to be provided at key locations to enable hand wash / hand sanitisation before starting work, before eating, etc.</p> <p>v. Gutkha, Paan, tobacco etc. to be banned from the site. Spitting to be strictly prohibited.</p> <p>vi. Screening at Gate with Contactless Thermometer & Action on Suspected Cases</p> <p>1) Security Personnel at the Gate to screen each person entering the premises using a non-contact infrared thermometer, which is duly serial numbered and calibrated.</p> <p>2) In case any site worker/ official is found to have fever more than 99 Degrees Fahrenheit or found coughing/ sneezing, he/she may be advised rest till recovery and entry to be permitted after obtaining clearance from medical officer/assistance/attendants.</p> <p>b. Any parcel/courier person should be stopped at gate only. Parcel to be collected from gate by concerned person preferably with provision of Special Box (wood/metal/plastic or the like) that can be sanitized daily. A provision of drop box at front of BHEL site office may also be deployed for receiving document like letter/invoice, etc. Parcels to be properly sanitized prior to opening.</p> <p>c. Any construction material received at site, unless properly sanitized, to be kept undisturbed for at least 3 days and to be used only after that period.</p> <p>d. Don't allow any new vehicle without concerned BHEL engineer permission.</p> <p>e. Ensure that number of persons coming inside and going outside is matching, agency wise.</p> <p>f. Visitor entry in site office to be avoided as far as possible.</p>	Security, Agency, BHEL
5	<p><u>Maintaining Strict Social Distancing during site/office activities – minimum 1 meter distance between any two personnel to be Enforced Strictly</u></p> <p>a. During meetings, classroom training programmes like induction training and on-the job training, toolbox talks and other gatherings, following precautions may be ensured:</p> <p>i. Preferably, such meetings to be avoided and communication carried out through other means (email, phone, pamphlets etc.)</p> <p>ii. At door, hand sanitizer or soap and water to be ensured for sanitizing hands during entry & exit by each individual</p> <p>iii. Only limited number of personnel to be called in training/ meeting, so as to ensure distance of minimum 1 meters between two participants</p> <p>iv. Each participant to wear mask</p>	Agency/ BHEL



OPERATIONAL CONTROL PROCEDURE

Doc. No.: HSEOCP: 61

Rev. No.: 01

Rev. Date: 01.06.2020

Page 5 of 13

OCP No. : 61

Resumption of Construction Activities After Lock Down and Prevention of Coronavirus Infection during Site Operations

- v. In case any individual is symptomatic/ coughing/ sneezing, he/ she may be taken to quarantine area by the medical/ first aid personnel, and medical assistance sought from specialized hospital, etc
- vi. Persons may be allowed to attend the induction training/ meeting only after temperature screening if felt necessary.

b. Social Distancing During Toolbox Talks

During Toolbox Talks, minimum 1 meter distance between any two workers to be ensured

c. During site execution activities:

- i. For all site execution activities, social distancing is to be maintained. In case this is not possible due to nature of work, speciality of work, etc, ensure sensitisation of the labour/staff involved and use of appropriate PPEs, especially mandatory face mask. In any case, close working to be allowed only in special circumstances and ensuring these activities are preferably time staggered to the extent possible
- ii. Ensure hand wash / hand sanitisation facility at key places and these are topped up regularly

d. In office premises:

- i. Sharing of items like pens, water bottles etc. in office premises to be avoided
- ii. Seating arrangement to be ensured to ensure minimum 1 meter distance
- iii. Doors preferably to be in open condition to avoid contact
- iv. All common touch points to be regularly disinfected.

6

Mandatory Face Masks for Everyone at All Times

- a. Face masks, and other necessary PPEs to be provided to all workers as per guidelines of Govt/ statutory authorities
- b. Those responsible for sanitation and cleaning of areas to be given coveralls
- c. **The Govt of India advisory available at following link gives details on how to prepare, use and clean such masks.**

<https://www.mohfw.gov.in/pdf/Advisory&ManualonuseofHomemadeProtectiveCoverforFace&Mouth.pdf>

- i. The workmen/staff may use home-made masks/ "gamchha" (गमछा) provided they are used effectively and constantly.
- ii. All site personnel to wear masks as specified at all times except possibly while having lunch/ tea. During that period, a distance of minimum **2 meters** to be maintained between two persons.
- iii. Minimum two masks to be ensured for each person – one can be used and other washed. Daily washing with detergent is mandatory
- iv. Strict directions for usage, washing of mask to be given to workers and officials. Masks are not to be touched from outside, and are to be put in soap solution on reaching residential quarters.
- v. There must not be a sharing of face covers and a face cover must be used by only one individual
- vi. Regular awareness by way of posters or daily briefing to be provided regarding correct usage, handling, washing, disposal etc of face masks/gamchhas/cloth etc

Concerned Individual/ Supervisor



OPERATIONAL CONTROL PROCEDURE

Doc. No.: HSEOCP: 61

Rev. No.: 01

Rev. Date: 01.06.2020

Page 6 of 13

OCP No. : 61

Resumption of Construction Activities After Lock Down and Prevention of Coronavirus Infection during Site Operations

d. Types of Masks and Use case scenarios

i. Homemade/ Reusable Face Covers:

- 1) Such home/ self-made face covers may be preferably used by all personnel. In case they can arrange better masks, same may be allowed.
- 2) In any case, no person to be permitted in site premises without a mask.

ii. Triple Layer Surgical Masks

- 1) These are disposable masks to be given to visitors/ used by workers and officials as per requirement.

iii. N95 Masks

- 1) Medical, security, and other officials, who come into contact with large number of people during the course of the day to be given N95 Masks
- 2) In addition, infected personnel and who are suspected of infection to use specialized masks as indicated by doctor

e. Minimum two sets of masks to be ensured with everyone so that one can be used while other is washed

7

Mask cleaning/ disposal

The Govt of India guidelines in above link also give details on how to wash and dispose the masks. Same to be followed.

In addition,

- a. For re-usable masks, in labor colony, separate area for cleaning masks to be identified, wherein all workers to wash the masks using detergent and water
- b. Cleaning of masks and availability of backup to be ensured by officials as well.
- c. **Safe disposal of Masks, Infected clothing, items etc.**
 - i. Each location to have separate bin for collecting used disposable masks and possibly infected items.
 - ii. All these bins to be collected daily and disposed of by trained staff wearing proper PPEs

Concerned Individual, Agency, BHEL

8

Provision of Food & Refreshments

- a. **Workers:** Tea for workers may be avoided. In case necessary, strict social distancing to be ensured, besides hand washing. It is preferable to let the labour bring their own cups/glasses or else use of disposable paper based cups to be encouraged
 - i. Tea cups may be arranged by the server and picked by worker in contactless manner.
 - ii. Food for workers may be served in packets.
 - iii. **Preparation:** Common food preparation to be carried out under strict hygiene with cooks wearing gloves and masks. A guard specifically to monitor the health of the cooks may be deployed, who can warn the management regarding any possible health issues.
 - iv. At tea/ food distribution area, social distancing norms to be ensured
- b. **Officials:** A far as possible, home cooked food to be preferred. In case not possible, packed food to be delivered at each seat, prepared in hygienic fashion as above

Agency/ BHEL



OPERATIONAL CONTROL PROCEDURE

Doc. No.: HSEOCP: 61

Rev. No.: 01

Rev. Date: 01.06.2020

Page 7 of 13

OCP No. : 61

Resumption of Construction Activities After Lock Down and Prevention of Coronavirus Infection during Site Operations

9	<p style="text-align: center;"><u>General Precautions in Site Areas</u></p> <ol style="list-style-type: none"> a. Workers to be instructed to maintain social distancing of minimum 1 m at all time (tool box meeting, tea time lunch time, gate entry time and drinking/service water area) b. Daily Tool Box Meeting to also include awareness about COVID 19 and precautionary measures to prevent spread. c. No other group meeting to be conducted preferably. d. Contractor to keep their working area clean and hygienic. Disinfectant spray/powders to be applied daily at common places (eating place, drinking water area, service water area and transport vehicles) e. All the workers during resting also, to maintain physical distance of at least 1 meter. Subcontractor has to disinfect the rest shelter at regular intervals. f. Subcontractor may keep sanitizer/hand wash in sufficient numbers at all common points. g. All hanging load must be inspected before starting work. A committee can be formed by each contractor to ensure all these pre start up inspections are done and submit the report to BHEL. h. Sanitizer may be kept at stair case entrance, lift entry point etc. Lifts to be avoided to the extent possible, and staircases preferred i. If any worker is found with COVID-19 symptom, he/she has to be sent to quarantine chamber immediately by medical personnel and medical assistance sought. Contractor to maintain extra room to keep person with symptom in quarantine. j. Workers may be advised to keep separate water bottles. Common water bottles/mugs/glasses to be preferably avoided. k. Contact Biometric attendance system is strictly prohibited till such advisory is in place. l. Regular disinfection of all Areas, Equipment and facilities <ol style="list-style-type: none"> i. Each agency to prepare the disinfecting plan and act accordingly. ii. A dedicated disinfectant gang to be identified for the task by each agency. The disinfectant gang to be provided full body suits for the task. iii. All areas (including office premises, site areas, chairs, tables, furniture etc.), tools & equipment to preferably be disinfected by dedicated gang every day before resumption of work. iv. Common touch points like handrails, lift buttons, door/window knobs or handles, vehicle door handles, taps, conference room & dining hall tables/chairs, common sofas/chairs, visitor sofa/chairs, files & folders, etc to preferably be disinfected regularly at frequent intervals every day. v. Pool vehicles, to be disinfected after every use. Social distancing to be maintained inside the common pool vehicles as per Govt./ statutory body guidelines. m. Provision of Disinfectant Spraying Machine and Disinfectant Chemical <ol style="list-style-type: none"> i. Provision of disinfectant machine may be deployed for faster disinfection of surfaces, premises, offices etc. The indicative composition of disinfectant chemicals is given in Corp HR Circular No. AA:HR:MR 1 (C) dated 20-03-2020 n. Disinfecting the operator/driver touch points of Vehicles/cranes, T&Ps etc. Disinfection to also be carried out for all Cranes, Vehicles, Equipment, consoles, T&Ps etc. which come into contact with operating personnel. o. Mandatory Disinfecting of all PPEs, Tools & Items on daily basis All PPEs, Tools & Items to be disinfected mandatorily before use/ issue and also those in stores 	Agency/ BHEL
---	--	--------------



OPERATIONAL CONTROL PROCEDURE

Doc. No.: HSEOCP: 61

Rev. No.: 01

Rev. Date: 01.06.2020

Page 8 of 13

OCP No. : 61

Resumption of Construction Activities After Lock Down and Prevention of Coronavirus Infection during Site Operations

	<p>p. Posters on COVID-19</p> <p>q. Sufficient Posters on COVID-19 to be ensured across the site in languages understood by most workers. Contractor to display precautionary measures, 'Do's and Don'ts' at prominent places in languages spoken by their workers.</p> <p>r. Provision of Hand-Hygiene at Site</p> <p>1) In order to ensure hand-hygiene at site, wash basins with sufficient flowing water (going to drain after washing – not re-usable) to be installed at various locations. Here flowing water means water flowing from any tap or poured from tanker/sump/tank etc. Dipping hands into water in buckets/tanks/sumps etc for the purpose of washing is strictly prohibited as it is counter-productive.</p> <p>2) Brief guidelines for hand washing are as below:</p> <ol style="list-style-type: none"> i. Soap to be provided at each wash basin and replenished regularly. ii. Washing with soap for at least 20 seconds is recommended. iii. As a general guideline, for every 100 workers, 1 wash-basin may be provided at site areas. iv. Close queue to be avoided near wash-basins and 1-meter distance to be maintained. Round markers at 1-meter distance can be ensured as guidance <p>s. Penalty</p> <ol style="list-style-type: none"> i. To ensure compliance penalty may be imposed in line with district administration norms or higher for not wearing mask or violating social distancing guidelines. ii. Concerned subcontractor may also be warned of stricter penalties in case of continued negligence 	
10	<p style="text-align: center;"><u>Labor Colony</u></p> <p>Following guidelines for COVID Prevention in labor colony may be followed:</p> <ol style="list-style-type: none"> a. All relevant guidelines in Corporate HSE Circular BHEL:CO: SOP : COVID-19 : 01 to be followed b. HSEOCP No. 61A for Labor Colony. c. Any other guidelines issued by applicable Govt/ Statutory authorities 	Agency/ BHEL
11	<p style="text-align: center;"><u>Provision of Quarantine Chambers</u></p> <ol style="list-style-type: none"> a. In labor colony/ near site, a temporary home quarantine/ isolation chamber may be set up to keep possible infected cases (with cough, cold, fever or other symptoms) until further medical help arrives. Quarantine chamber should be away from labor colony tenements. b. Similar arrangement of quarantine chambers may be set up at Site premises. c. Necessary arrangements for quarantine shall be as per Govt./ statutory body guidelines 	Agency/ BHEL
12	<p style="text-align: center;"><u>Action in case any individual is suspected of COVID infection or showing symptoms</u></p> <p>In case any suspected COVID-19 case is found or an individual is showing symptoms like cough/ cold/ fever etc.:</p> <ol style="list-style-type: none"> a. Immediately alert BHEL HQ & Corporate office, Customer, Local authorities/ district administration, etc b. Arrange to take the individual to the COVID testing or COVID care facility as per advise of local authorities/district administration c. Sanitize and disinfect immediately all the areas where the person would have visited in the Project premises and labour colony etc. 	Agency/ BHEL



OPERATIONAL CONTROL PROCEDURE

Doc. No.: HSEOCP: 61

Rev. No.: 01

Rev. Date: 01.06.2020

Page 9 of 13

OCP No. : 61

Resumption of Construction Activities After Lock Down and Prevention of Coronavirus Infection during Site Operations

	<p>d. Co-operate with the local authorities in identifying and tracing individuals who might have come in close contact with the suspected person. Take immediate action as advised by the local authorities/ district administration, customer, etc including cordoning off or sealing of the area.</p> <p>e. Apprise BHEL offices and customer regularly.</p>	
13	<p style="text-align: center;"><u>Liaison with Specialty Hospitals for COVID-19</u></p> <p>a. Liaison with specialty hospitals for COVID-19 test/treatment facility, for timely care to suspected individuals, and advice.</p> <p>b. Information regarding local authorities dealing with COVID to be maintained</p> <p>c. Addresses of COVID centers for possible scenarios to be maintained</p>	BHEL
14	<p style="text-align: center;"><u>Hazmat Suits and N95 Masks for Medical Personnel</u></p> <p>Medical Personnel at site to be provided hazmat suits besides N95 masks</p>	BHEL
15	<p style="text-align: center;"><u>Training/ Awareness regarding COVID-19</u></p> <p>All site personnel to be given inputs on COVID-19 regularly covering following broad topics: (Workers may be given Pep Talk once a month through Audio-Visual Medium and daily through toolbox talks and officials to be informed in internal meetings as and when they happen.</p> <p>Every meeting to begin with brief discussion on COVID-19 and need to ensure precautions like masks and social distancing).</p> <p>Suggested topics are given below:</p> <p>a. What is COVID-19 & How it spreads through coughing, sneezing and touching mucous membranes like mouth, eyes after touching infected surface</p> <p>b. What are the symptoms of COVID-19, namely coughing accompanied with fever and flu-like symptoms including running nose and sneezing</p> <p>c. The highly infectious spread, Number of infections and fatalities in the world from this disease</p> <p>d. Fatality rate from COVID-19 varies from 1-10% and individuals with preexisting conditions like heart diseases, diabetes, kidney & liver problems, smokers are more vulnerable to have serious effects from Coronavirus infection</p> <p>e. How COVID-19 infected individual can be asymptomatic, but can still infect friends and family members. Infected individual can be immune, but friends and family members can develop serious issues, so it is best to be protected to avoid problems for friends & family and especially elders</p> <p>f. According to studies, Coronavirus can stay on surfaces from few hours to few days, so touching of unknown surfaces to be avoided and hands washed/ sanitized frequently</p> <p>g. There is no cure/ vaccine for this disease so far</p> <p>h. Prevention is the only cure</p> <p>i. Best way to save oneself is to wear mask at all times and not to touch surfaces and protect oneself from infection from respiratory droplets</p>	Agency/ BHEL
16	<p style="text-align: center;"><u>Keeping Updated on COVID-19 in the Area/ Locality</u></p> <p>Site to remain vigilant about any reported COVID-19 cases in the vicinity and take appropriate precautions/actions as advised by the local authorities/district administration</p>	Agency/ BHEL

	OPERATIONAL CONTROL PROCEDURE	Doc. No.: HSEOCP: 61
		Rev. No.: 01 Rev. Date: 01.06.2020 Page 10 of 13
OCP No. : 61	Resumption of Construction Activities After Lock Down and Prevention of Coronavirus Infection during Site Operations	

17	<p style="text-align: center;"><u>Staggered Shifts to Avoid Contact during Commute</u></p> <p>a. Staggered deployment of labour/staff to be ensured to prevent accumulation of people in work areas as well as in common transport vehicles. Aim is to ensure distance of minimum 1 meter between two occupants</p> <p>b. Drivers to also wear protective masks, preferably N95</p> <p>c. Proper air circulation and ventilation to be ensured in vehicles</p>	Agency/ BHEL
18	<p style="text-align: center;"><u>Air circulation, filtering and ventilation in Office Premises & Training Halls</u></p> <p>a. Air circulation to be ensured in closed areas</p> <p>b. Well ventilated areas/rooms preferred to air conditioning, to the extent possible</p>	Agency/ BHEL
19	<p style="text-align: center;"><u>Guidelines to handle outside papers (eg. At Weigh bridge area, LR copies, gate passes, documents, etc.)</u></p> <p>1. All involved personnel to strictly maintain 1-meter distance and all social distancing and other guidelines</p> <p>2. PPES like Face mask and gloves to be necessarily worn by the dealing person.</p> <p>3. If required, papers to be handled using long forceps, ironed on both sides using hot iron, and then handled (with gloves)</p> <p>4. The driver/ visitor must always wear mask and maintain distance</p>	Agency/ BHEL
20	<p style="text-align: center;"><u>General/ Other</u></p> <p>1. Shift roster should be followed,</p> <p>2. Mass gathering meetings should not be conducted. Communications/meetings to be preferably through telephone, Mail, WhatsApp, Web-ex, etc. Face to face meetings to be preferably avoided. In case of unavoidable situations, social distancing to be maintained.</p> <p>3. Canteen to remain closed preferably.</p> <p>4. Committee may be formed to monitor implementation of COVID-19 prevention steps besides hygiene and fulfillment of essential needs at labor colony.</p> <p>5. Office common areas may be sanitized daily (door handle, pantry, washrooms, common printers and other common areas)</p> <p>6. Vehicle seats and door handle to be sanitized daily.</p> <p>7. Vehicle arrangement to be made so as to maintain social distancing. Extra persons should not travel in the vehicle. As per Corporate HSE circular, not more than 3 personnel to travel in a single site vehicle (6 seater) at a time</p> <p>8. After lock down period, on resumption of work, all office equipment such as PC, Printers, AC, etc. are to be disinfected and started one by one after checking for any wear & tear due to rodent acts during lockdown.</p> <p>9. Banning animals from site: As per recent reports, Coronavirus is also spreading to animals. Hence, all animals may preferably be expelled from site.</p>	Agency/ BHEL

Note:

1. Other precautions as deemed necessary by concerned sites may be ensured in order to ensure strict precautions to prevent even a single case of Coronavirus Infection
2. Responsibilities are only indicative – to be decided at Site Level

	OPERATIONAL CONTROL PROCEDURE	Doc. No.: HSEOCP: 61 Rev. No.: 01 Rev. Date: 01.06.2020 Page 11 of 13
OCP No. : 61	Resumption of Construction Activities After Lock Down and Prevention of Coronavirus Infection during Site Operations	

Some Useful Links

A. Internet links of Govt and other authoritative sources on COVID-19 and Coronavirus are listed below:

1. MyGov COVID-19-19 Page: <https://www.mygov.in/COVID-19/>
2. Preventive Measures (Advisory) :<https://www.mohfw.gov.in/pdf/PreventivemeasuresDOPT.pdf>
3. Guidelines for Home Quarantine: <https://www.mohfw.gov.in/pdf/Guidelinesforhomequarantine.pdf>
4. Guidelines for COVID-19 Quarantine Facilities:<https://ncdc.gov.in/WriteReadData/l892s/90542653311584546120.pdf>
5. Posters, Dos, Don'ts on COVID-19:<https://www.mohfw.gov.in/>
6. Miscellaneous guidelines and circulars: <https://www.nhp.gov.in/whatsnew>
7. Advisory for Ensuring Safe Drinking Water : <https://www.mohfw.gov.in/pdf/advisorydrinkingwaterpdf.pdf>

B. World Health Organization:

1. Infection Prevention & Control :<https://www.who.int/emergencies/diseases/novel-coronavirus-2019/technical-guidance/infection-prevention-and-control>
2. Advice for Public : <https://www.who.int/emergencies/diseases/novel-coronavirus-2019/advice-for-public>
3. Points of Entry & Mass Gatherings: <https://www.who.int/emergencies/diseases/novel-coronavirus-2019/technical-guidance/points-of-entry-and-mass-gatherings>

Coronavirus Self Declaration Form

- 1) Name:
- 2) Age:
- 3) Father's Name:
- 4) Agency:
- 5) Identification Number.....Identification Type.....
- 6) Arriving from:
- 7) Are you arriving from any COVID Hot Spots or Containment Zones? If Yes, please give details:

8) Have you come in contact in with relatives/ friends/ people infected, suspected or diagnosed with COVID-19 in last 21 days? If Yes, please provide your relationship with people and your last contact date with them:

9) Have you been advised quarantine/ isolation or undergone treatment w.r.t. COVID-19? If Yes, please provide details (date, duration, location, medical report etc.):

10) Please state if you have experienced/ are experiencing any of the following symptoms:

Symptom	Yes	No
i) Fever		
ii) Cough		
iii) Shortness of Breath		
iv) Persistent pain in the Chest		

I acknowledge that the information I have given is accurate and complete.

Date:

Place:

Signature:

	OPERATIONAL CONTROL PROCEDURE	Doc. No.: HSEOCP: 61
		Rev. No.: 01 Rev. Date: 01.06.2020 Page 13 of 13
OCP No. : 61	Resumption of Construction Activities After Lock Down and Prevention of Coronavirus Infection during Site Operations	

Site to follow all the general safety precautions as per this OCP.

In addition, relevant records pertaining to actions taken to be prepared and kept.

Records:

Record Title	Record No.	Location	Responsibility	Retention Period

Verification, Corrective and Preventive Action:

HOD / Site In-charge shall ensure effective implementation of the above procedure. In case of any deviation, shall take suitable corrective and preventive action.

Revision History

Revision Date	Revision No.	Old Text	New Text	Reason	Revised by
18/04/2020	00	-	-	First Issue	As indicated on Page 1
01/06/2020	01	-	Besides general improvements/ corrections, modifications as below: Added (Other clauses shifted by 2): 1. Deployment of COVID Marshalls 2. Directions for newly Joining Workers/ Officials; Addition of Format F1 Edited: 4. Construction material, unless sanitized to be kept undisturbed for 3 days 6. Sanitization staff to be given coveralls 10. Reference to OCP 61A for COVID Prevention in labor colony added	New Govt. guidelines/ general improvements	PSHQ-HSE

	<h2>OPERATIONAL CONTROL PROCEDURE</h2>	Doc. No.: HSEOCP: 61A
		Rev. No.: 00 Rev. Date: 27.04.2020 Page 1 of 3
OCP No. : 61A	Prevention of COVID-19 Infection in Labor Colony	

Purpose	➤ To ensure necessary precautions in Labor Colony in order to prevent spread of Infectious diseases like COVID-19 among residents	Scope	PS Regions
Applicability	➤ This SOP applies to labor colonies at project sites.		
Responsibility	Concerned Site In-charge / Site HSE Head/Package Head		
Performance Criteria	Number of cases of violations from these guidelines. Violations must be recorded and compliances be done for the same immediately/ within a day		
References	➤ HSEOCP:61 and all References therein This OCP is an Annexure to HSEOCP 61)		

Procedures and Controls		
S No	Activity	Responsibility
1	<p style="text-align: center;"><u>General</u></p> <p>a. Norms for social distancing, training/ awareness, face masks, disinfection, sanitization, gate entry, quarantine, medical, action in case of suspect COVID cases etc. as indicated in HSEOCP:61, Corporate HSE Circular BHEL:CO: SOP: COVID-19 : 01 and Govt. guidelines</p> <p>b. Each labor colony will be secured preferably by a boundary wall and gate, manned by a guard. Only workers with valid ID cards to be let inside</p> <p>c. New workers should not be allowed to enter colony without health checkup.</p>	Agency, BHEL
2	<p style="text-align: center;"><u>Precautions for Living Rooms & Common Areas in Labor Colony</u></p> <p>a. Spacing of minimum 2 meters between living areas of workers inside a room may be maintained. Preferably, the living area of each worker may be partitioned using sheet of cloth, plastic etc.</p> <p>b. Rooms to be properly ventilated as far as possible</p> <p>c. Sanitation to be given prime importance and personal hygiene to be promoted</p> <p>d. Outside every common facility, eg. Toilet, washroom, food hall/ canteen etc., provision of washbasin with water (flowing water preferably) and soap (preferably liquid soap) to be ensured</p> <p>e. Round markers with chalk at 1-2 meter distance to prevent crowding at each common facility like toilet, washroom, drinking water point, washing area, mess/ canteen etc.</p> <p>f. Staggered shift planning – In case the capacity of infrastructure and facilities like toilets, washrooms, canteen etc. is not sufficient, workers can be assigned staggered shifts so as to not overwhelm the facilities. A group can depart before the next group starts to get ready. Detailed assessment and planning in this regard is to be carried out by each concerned agency</p> <p>g. Face masks shall be worn by everyone inside the colony premises (Refer 1(a)).</p> <p>h. Sanitisation/Disinfection of all areas to be carried out regularly (Refer 1(a)).</p> <p>i. Spitting of Pan. Gutkha etc. inside the colony and urinating etc. outside the toilets to be strictly avoided</p> <p>j. Regular visits by Doctors to the labor colony can be arranged on non-working day for check-up of all workers</p> <p>k. Banning animals from labor colony: As per recent reports, Coronavirus is also spreading among animals. Hence, all animals to preferably be expelled from labour colony.</p> <p>l. Necessary social distancing to be ensured during cooking and taking food. Separate water bottles, utensils etc to be preferably maintained by each worker to prevent infection. Common cooking to be preferably avoided. In case necessary, adequate care to be taken especially w.r.t. health and well-being of the cook and maintaining proper distance during serving food/ tea etc.</p>	Agency/ BHEL



OPERATIONAL CONTROL PROCEDURE

Doc. No.: HSEOCP: 61A

Rev. No.: 00

Rev. Date: 27.04.2020

Page 2 of 3

OCP No. : 61A

Prevention of COVID-19 Infection in Labor Colony

- | | |
|--|--|
| | <p>m. Identification of “COVID Wardens” (CWs) by each agency for maintaining the following:</p> <ol style="list-style-type: none"> i. Keeping an eye on the health of workers and report any suspected cases of fever, coughing etc. to the management ii. Keeping an eye on the social distancing measures in the labor colony and report any non-conformances to the management. iii. Educate the workers about social distancing and COVID prevention measures. <p>n. Training/ Awareness regarding COVID-19</p> <ol style="list-style-type: none"> i. Workers to be instructed to maintain social distancing of minimum 1 m at all time ii. Posters on COVID-19: Sufficient Posters on COVID-19 to be ensured across the labor colony in languages understood by most workers. iii. All workers to be instructed to inform any suspected cases of illness (individual or others) to an emergency contact number of CW, The emergency contact numbers and CW contact numbers to be displayed at prominent locations <p>o. Commute to/ from Labor Colony</p> <ol style="list-style-type: none"> i. Social distancing precautions and masks to be strictly ensured during commute between labor colony and site. Govt. guidelines on occupancy of the vehicles to be followed. ii. In case vehicles are used, concerned drivers to be instructed to keep a watch on the occupants following the necessary social distancing measures and wearing masks. <p>p. Inspection & Review</p> <ol style="list-style-type: none"> i. Daily Inspection by concerned COVID Wardens and reporting to Agency ii. Regular inspection by Agency & BHEL |
|--|--|

Note:

1. Other precautions as deemed necessary by concerned sites may be ensured in order to prevent Coronavirus Infections. This OCP suggests minimum requirements. However, Sites may consider alternative actions based on feasibility and circumstances, while adhering to GOI/District Administration/Local Authority guidelines, issued from time to time for social distancing, sanitation, use of face masks, etc
2. Responsibility assignments are only indicative – to be decided at Site Level



OPERATIONAL CONTROL PROCEDURE

Doc. No.: HSEOCP: 61A
Rev. No.: 00
Rev. Date: 27.04.2020
Page 3 of 3

OCP No. : 61A

Prevention of COVID-19 Infection in Labor Colony

Site to follow all the general safety precautions as per this OCP.

In addition, relevant records pertaining to actions taken to be prepared and kept.

Records:

Record Title	Record No.	Location	Responsibility	Retention Period

Verification, Corrective and Preventive Action:

HOD / Site In-charge shall ensure effective implementation of the above procedure. In case of any deviation, shall take suitable corrective and preventive action.

Revision History

Revision Date	Revision No.	Old Text	New Text	Reason	Revised by
27/04/2020	00	-	-	First Issue	PSHQ-HSE

PROFORMA OF BANK GUARANTEE (in lieu of SECURITY DEPOSIT)

In consideration of the Bharat Heavy Electricals Limited (hereinafter referred to as the 'Employer' which expression shall unless repugnant to the context or meaning thereof, include its successors and permitted assigns) incorporated under the Companies Act, 1956 and having its registered office at BHEL House, Siri Fort, Asiad, New Delhi – 110049 through its Unit at Bharat Heavy Electricals Limited, Power Sector Eastern Region, BHEL Bhawan, Plot No 9/1, DJ Block, Sector-II, Salt lake City, Kolkata – 700091 having agreed to exempt (Name of the Vendor / Contractor / Supplier) having its registered office at _____¹ (hereinafter called the said Contractor which term includes supplier), from demand under the terms and conditions of the Contract reference No. _____² dated _____² valued at Rs.....² (Rupees -----)² for <Nature of the Work>³ (hereinafter called the said Contract) of Security Deposit for the due fulfilment by the said contractor of the terms and conditions contained in the said Contract, on production of a Bank Guarantee for Rs. _____⁴ (Rupees _____ only), we _____ (indicate the name and address of the Bank) having its Head Office at _____ (address of the head Office) (hereinafter referred to as the Bank) at the request of _____ [Name of Contractor(s)] do hereby undertake to pay to the Employer an amount not exceeding Rs. _____ in the event of any breach by the said Contractor(s) of any of the terms and conditions contained in the said Contract.

We, _____ (indicate the name of the Bank), do hereby undertake to pay the amounts due and payable under this guarantee without any demur, merely on a demand from the Employer. Any such demand made on the bank, shall be conclusive as regards the amount due and payable by the Bank under this guarantee. However, our liability under this guarantee shall be restricted to an amount not exceeding Rs. _____.

We undertake to pay to the Employer any money so demanded notwithstanding any dispute or disputes raised by the Contractor(s) in any suit or proceeding pending before any Court or Tribunal relating thereto our liability under this present being absolute and unequivocal.

The payment so made by us under this guarantee shall be a valid discharge of our liability for payment hereunder and the Contractor(s) shall have no claim against us for making such payment.

We, further agree that the guarantee herein contained shall remain in full force and effect during the period that would be taken for the performance of the said Contract and that it shall continue to be enforceable till all the dues of the Employer under or by virtue of the said Contract have been fully paid and its claim satisfied or discharged or till _____⁵ or till the office/Department/Division of Bharat Heavy Electricals Limited certifies that the terms and conditions of the said Contract have been fully and properly carried out by the said contractor(s) and also including the satisfactory performance of the equipment during guarantee period and accordingly discharges this guarantee. Unless a demand or claim under this guarantee is made on us in writing on or before the _____⁶, (3 months more than the present date of validity of Bank Guarantee) we shall be discharged from all the liability under this guarantee thereafter.

We, _____ (indicate the name of the Bank) _____ further agree with the Employer that the Employer shall have the fullest liberty without our consent and without affecting in any manner our obligations hereunder to vary any of the terms and conditions of the said Contract or to extend time of performance by the said contractor(s) from time to time or to postpone for any time or from time to time any of the powers exercisable by the Employer against the said contractor(s) and to forbear or enforce any of the terms and conditions relating to the said Contract and we shall not be relieved from our liability by any reason of any such variation or extension being granted to the said contractor(s) or for any forbearance, act or omission on the part of the Employer or any indulgence by the Employer to the said contractor(s) or by any such matter or thing whatsoever which under the law relating to sureties would but for this provision have effect of so relieving us.

This guarantee will not be discharged due to the change in the constitution of the Bank or the Contractor(s).

We,..... BANK lastly undertake not to revoke this guarantee during its currency except with the previous consent of the Employer in writing.

Notwithstanding anything to the contrary contained hereinabove:

- a) The liability of the Bank under this Guarantee shall not exceed.....⁷
- b) This Guarantee shall be valid up to⁸
- c) Unless the Bank is served a written claim or demand on or before _____⁹ (3 months more than the present date of validity of Bank Guarantee) all rights under this guarantee shall be forfeited and the Bank shall be relieved and discharged from all liabilities under this guarantee irrespective of whether or not the original bank guarantee is returned to the Bank.

We, _____ (indicate the name of the Bank) _____ lastly undertake not to revoke this guarantee during its currency except with the previous consent of the Employer in writing.

Any claim or dispute arising under the terms of this document shall only be enforced or settled in the courts of at Kolkata only.

Date _____ Day of _____
for _____ (indicate the name of the Bank) _____

(Signature of Authorised signatory)

¹ NAME AND ADDRESS OF THE VENDOR /CONTRACTOR / SUPPLIER .

² DETAILS ABOUT THE NOTICE OF AWARD/CONTRACT REFERENCE

³ PROJECT/SUPPLY DETAILS

⁴ BG AMOUNT IN FIGURES AND WORDS

⁵ VALIDITY DATE

⁶ DATE OF EXPIRY OF CLAIM PERIOD

⁷ BG AMOUNT IN FIGURES AND WORDS.

⁸ VALIDITY DATE

⁹ DATE OF EXPIRY OF CLAIM PERIOD

Note:

1. Units are advised that expiry of claim period may be kept 2/3 months after validity date.
2. In Case of Bank Guarantees submitted by Foreign Vendors-
 - a. From Nationalized/Public Sector / Private Sector/ Foreign Banks (BG issued by Branches in India) can be accepted subject to the condition that the Bank Guarantee should be enforceable in the town/city or at nearest branch where the Unit is located i.e. Demand can be presented at the Branch located in the town/city or at nearest branch where the Unit is located.
 - b. From Foreign Banks (wherein Foreign Vendors intend to provide BG from local branch of the Vendor country's Bank)
 - b.1 In such cases, in the Tender Enquiry/ Contract itself, it may be clearly specified that Bank Guarantee issued by **any of the Consortium Banks only** will be accepted by BHEL. As such, Foreign Vendor needs to make necessary arrangements for issuance of Counter-Guarantee by Foreign Bank in favour of the Indian Bank (BHEL's Consortium Bank). It is

advisable that all charges for issuance of Bank Guarantee/ counter- Guarantee should be borne by the Foreign Vendor. The tender stipulation should clearly specify these requirements.

- b.2** In case, Foreign Vendors intend to provide BG from Overseas Branch of our Consortium Bank (e.g. if a BG is to be issued by SBI Frankfurt), the same is acceptable. However, the procedure at **sl.no. b.1** will required to be followed.
- b.3** The BG issued may preferably be subject to Uniform Rules for Demand Guarantees (URDG) 758 (as amended from time to time). In case, of Foreign Vendors, the BG Format provided to them should clearly specify the same.
- b.4** The BG should clearly specify that the demand or other document can be presented in electronic form.

BANK GUARANTEE FOR PERFORMANCE SECURITY

Bank Guarantee No:

Date:

To

NAME

& ADDRESSES OF THE BENEFICIARY

Dear Sirs,

In consideration of the Bharat Heavy Electricals Limited (hereinafter referred to as the 'Employer' which expression shall unless repugnant to the context or meaning thereof, include its successors and permitted assigns) incorporated under the Companies Act, 1956 and having its registered office at BHEL House, Siri Fort, Asiad, New Delhi – 110049 through its Unit at Bharat Heavy Electricals Limited, Power Sector Eastern Region, BHEL Bhawan, Plot No 9/1, DJ Block, Sector-II, Salt lake City, Kolkata – 700091 having awarded to (Name of the Vendor / Contractor / Supplier) having its registered office at _____¹ hereinafter referred to as the 'Contractor/Supplier', which expression shall unless repugnant to the context or meaning thereof, include its successors and permitted assigns), a contract Ref No.....dated² valued at Rs.....² (Rupees -----)for <Nature of Work>³ (hereinafter called the 'Contract') and the Contractor having agreed to provide a Contract Performance Guarantee, equivalent to% (... Percent) of the said value of the Contract to the Employer for the faithful performance of the Contract,

we,, (hereinafter referred to as the Bank), having registered/Head office at and inter alia a branch at being the Guarantor under this Guarantee, hereby, irrevocably and unconditionally undertake to forthwith and immediately pay to the Employer a maximum amount Rs ----- (Rupees -----)⁴ without any demur, immediately on a demand from the Employer, . Any such demand made on the Bank shall be conclusive as regards the amount due and payable by the Bank under this guarantee. However, our liability under this guarantee shall be restricted to an amount not exceeding Rs. _____.

We undertake to pay to the Employer any money so demanded notwithstanding any dispute or disputes raised by the Contractor/ Supplier in any suit or proceeding pending before any Court or Tribunal relating thereto our liability under this present being absolute and unequivocal.

The payment so made by us under this Guarantee shall be a valid discharge of our liability for payment thereunder and the contractors/supplier shall have no claim against us for making such payment.

We thebank further agree that the guarantee herein contained shall remain in full force and effect during the period that would be taken for the performance of the said Contract and that it shall continue to be enforceable till all the dues of the Employer under or by virtue of the said Contract have been fully paid and its claims satisfied or discharged.

We BANK further agree with the Employer that the Employer shall have the fullest liberty without our consent and without affecting in any manner our obligations hereunder to vary any of the terms and conditions of the said Contract or to extend time of performance by the said Contractor/Supplier from time to time or to postpone for any time or from time to time any of the powers exercisable by the Employer against the said Contractor/Supplier and to forbear or enforce any of the terms and conditions relating to the said Agreement and we shall not be relieved from our liability by reason of any such variation, or extension being granted to the said Contractor/Supplier or for any forbearance, act or omission on the part of the Employer or any indulgence by the Employer to the said Contractor/Supplier or by any such matter or thing whatsoever which under the law relating to sureties would but for this provision have effect of so relieving us.

The Bank also agrees that the Employer at its option shall be entitled to enforce this Guarantee against the Bank as a principal debtor, in the first instance without proceeding against the Contractor and notwithstanding any security or other guarantee that the Employer may have in relation to the Contractor's liabilities.

This Guarantee shall remain in force upto and including.....⁵ and shall be extended from time to time for such period as may be desired by Employer.

This Guarantee shall not be determined or affected by liquidation or winding up, dissolution or change of constitution or insolvency of the Contractor/Supplier but shall in all respects and for all purposes be binding and operative until payment of all money payable to the Employer in terms thereof.

Unless a demand or claim under this guarantee is made on us in writing on or before the⁶ (3 months more than the present date of validity of Bank Guarantee) we shall be discharged from all liabilities under this guarantee thereafter.

We, BANK lastly undertake not to revoke this guarantee during its currency except with the previous consent of the Employer in writing.

Notwithstanding anything to the contrary contained hereinabove:

- a) The liability of the Bank under this Guarantee shall not exceed.....⁷
- b) This Guarantee shall be valid up to⁸
- c) Unless the Bank is served a written claim or demand on or before _____⁹ (3 months more than the present date of validity of Bank Guarantee) all rights under this guarantee shall be forfeited and the Bank shall be relieved and discharged from all liabilities under this guarantee irrespective of whether or not the original bank guarantee is returned to the Bank.

We, _____ Bank, have power to issue this Guarantee under law and the undersigned as a duly authorized person has full powers to sign this Guarantee on behalf of the Bank.

Any claim or dispute arising under the terms of this document shall only be enforced or settled in the courts of at Kolkata only.

For and on behalf of
(Name of the Bank)

Dated.....

Place of Issue.....

¹ NAME AND ADDRESS OF THE VENDOR /CONTRACTOR / SUPPLIER.

² DETAILS ABOUT THE NOTICE OF AWARD/CONTRACT REFERENCE

³ PROJECT/SUPPLY DETAILS

⁴ BG AMOUNT IN FIGURES AND WORDS

⁵ VALIDITY DATE

⁶ DATE OF EXPIRY OF CLAIM PERIOD

⁷ BG AMOUNT IN FIGURES AND WORDS.

⁸ VALIDITY DATE

⁹ DATE OF EXPIRY OF CLAIM PERIOD

Note:

1. Units are advised that expiry of claim period may be kept 2/3 months after validity date.

2. In Case of Bank Guarantees submitted by Foreign Vendors-

a. From Nationalized/Public Sector / Private Sector/ Foreign Banks (BG issued by Branches in India) can be accepted subject to the condition that the Bank Guarantee should be enforceable in the town/city or at nearest branch where the Unit is located i.e. Demand can be presented at the Branch located in the town/city or at nearest branch where the Unit is located.

b. From Foreign Banks (wherein Foreign Vendors intend to provide BG from local branch of the Vendor country's Bank)

b.1 In such cases, in the Tender Enquiry/ Contract itself, it may be clearly specified that Bank Guarantee issued by **any of the Consortium Banks only** will be accepted by BHEL. As such, Foreign Vendor needs to make necessary arrangements for issuance of Counter- Guarantee by Foreign Bank in favour of the Indian Bank (BHEL's Consortium Bank). It is advisable that all charges for issuance of Bank Guarantee/ counter- Guarantee should be borne by the Foreign Vendor. The tender stipulation should clearly specify these requirements.

b.2 In case, Foreign Vendors intend to provide BG from Overseas Branch of our Consortium Bank (e.g. if a BG is to be issued by SBI Frankfurt), the same is acceptable. However, the procedure at **sl.no. b.1** will required to be followed.

- b.3** The BG issued may preferably be subject to Uniform Rules for Demand Guarantees (URDG) 758 (as amended from time to time). In case, of Foreign Vendors, the BG Format provided to them should clearly specify the same.
- b.4** The BG should clearly specify that the demand or other document can be presented in electronic form.

List of Consortium Banks *			
	Nationalised Banks		Nationalised Banks
1	Allahabad bank	19	Vijaya Bank
2	Andhra bank		Public Sector Banks
3	Bank of Baroda	20	IDBI
4	Canara Bank		Foreign banks
5	Corporation bank	21	CITI Bank N.A
6	Central bank	22	Deutsche Bank AG
7	Indian Bank	23	The Hongkong and Shanghai Banking Corporation Limited
8	Indian Oversea Bank	24	Standard Chartered Bank
9	Oriental bank of Commerce	25	J P Morgan
10	Punjab National Bank		
11	Punjab & Sindh Bank		Private banks
12	State Bank of India	26	Axis Bank
13	State Bank of Hyderabad	27	The Federal Bank Limited
14	Syndicate Bank	28	HDFC
15	State Bank of Travancore	29	Kotak Mahindra Bank
16	UCO Bank	30	ICICI
17	Union Bank of India	31	Indusind Bank
18	United Bank of India	32	Yes Bank

* wef 22.03.2016

RTGS FORMAT

Form for getting payment through RTGS (Real Time Gross Settlement)

01. NAME OF VENDOR
02. ADDRESS
03. VENDOR'S BANK A/C NAME
04. VENDOR'S BANK A/C NO.
05. NAME OF BANK
06. NAME OF BRANCH
07. BRANCH PH. NO.
08. CITY
09. IFSC CODE OF THE BRANCH

THE CHARGES IF ANY FOR PAYMENT THROUGH RTGS MAY BE RECOVERED FROM THE BILL SUBMITTED BY US.

SIGNATURE OF AUTHORISED REPRESENTATIVE
OF VENDOR WITH DATE & SEAL

CONFIRMATION BY BANKER WITH
OFFICE SEAL

Note : Incorrect information will create accounting complications and payment will be delayed.

RTGS DETAILS OF BHEL-PSER FOR EFT BY BIDDER/CONTRACTOR

Form for getting payment through RTGS (Real Time Gross Settlement)

01. Name of Vendor **BHARAT HEAVY ELECTRICALS LTD.**
02. Address **~~BHEL~~ BHEL HOUSE, SIRI FORT, N.DELHI**
03. Vendors Bank A/c Name **BHARAT HEAVY ELECTRICALS LTD.**
04. Vendors Bank A/c No. **11107800029**
05. Name of Bank **STATE BANK OF INDIA**
06. Name of Branch **COMMERCIAL BR., SALT LAKE, SECTOR-V**
07. Branch Phone No. **KOLKATA**
08. City **033-23575666**
09. IFSC Code of the Branch **KOLKATA**
SBIN 0004289

The charges if any for payment through RTGS may be recovered from the Bill submitted by us.

Signature of Authorized Representative of Vendor
के. के. कोआरी / K. K. Coari
उप महाप्रबंधक (वित्त) / Dy. General Manager (Fin)
बी. एच. ई. एल. : पी.एस.ई.आर : कोलकाता - 700 091
BHEL: PSER / Kolkata-700 091

Confirmation by Banker with office seal

Note : Incorrect information will create Accounting complications and payment will be delayed



**GENERAL & SPECIAL CONDITIONS
OF CONTRACT [FOR SERVICES JOB]**

**PSER
KOLKATA**

SECTION – I
Instructions to Tenderers
GENERAL INSTRUCTION TO TENDERERS

1.1 Submission of Tender in “Three Parts”.

- (1) Technical Tender: All particulars asked for from the Vendor except the Price Bid & E.M.D in an envelope.
- (2) EMD in a sealed envelope clearly superscribing on the envelope “E.M.D”, the Tender Number, Name of Work, addresses of Vendor and addressee. One time EMD holders needn't enclose this provided that proof of EMD remittance is enclosed in the technical tender.
- (3) Price Bid in the price schedule enclosed in the tender, in sealed envelope, clearly superscribing “Price Bid”, Tender Number, Name of Work, Name of the Vendor and addressee.

All the above “Parts” can be placed in an sufficiently large outer envelope for submission.

1.1.1a This Tender specification as a whole, duly furnishing the following details shall be duly signed and sent in a sealed cover superscribing :

TENDER FOR _____
TENDER SPECIFICATION NO. _____
DUE ON _____

1.1.1b DURATION OF JOB

1.1.1.1 Earnest Money Deposit.

1.1.1.2 Income Tax & Sales Tax Clearance Certificate.

1.1.1.3 Detailed organisation chart for manpower resources available with the tenderer and to be employed for the present jobs.

1.1.1.4 Time to be taken for commencement and completion of Work.

1.1.1.5 A list of experience as mentioned in the tender document.

1.1.1.6 The details of the present jobs being handled.

1.1.1.7 Certificate from the BHEL's scheduled Banks to establish financial capability of the tenderer as per format enclosed at Annexure-I.

1.1.1.8 Attested copies of partnership deed, power of attorney and tender specifications duly signed as mentioned in the tender documents.

1.1.1.9 Price schedule and other relevant information.

NOTE: All Xerox copies enclosed by the Vendor should be attested and sealed for authenticity.



**GENERAL & SPECIAL CONDITIONS
OF CONTRACT [FOR SERVICES JOB]**

**PSER
KOLKATA**

- 1.1.2 The tender shall be addressed to:
**HEAD, PURCHASE DEPARTMENT
BHARAT HEAVY ELECTRICALS LIMITED,
POWER SECTOR, EASTERN REGION, (2ND FLOOR),
PLOT-9/1, BLOCK-DJ, SECTOR-II, SALT LAKE,
KOLKATA – 700091.**
- 1.1.3 Tenders submitted by post shall be sent “REGISTERED POST ACKNOWLEDGEMENT DUE” and shall be posted with the due allowance for any postal delay. The tenders received after the due date and time of opening are liable to be rejected. Telegraphic offers and offers received by telex may not be considered unless confirmed in writing by a detailed offer.
- 1.1.4 Tenders shall be opened by the authorised officer of BHEL at his office at the time and date as specified in the tender notice in the presence of such of those tenderers or their authorised representatives who may be present.
- 1.1.5 The Tenderer shall closely peruse all the clauses, specifications and drawings indicated in the Tender Documents before quoting. Should the tenderer have any doubt about the meaning of any portion of the Tender Specifications or find discrepancies or omission in the drawings or the tender documents issued are incomplete or shall require clarification on any of the technical aspect, scope of work etc., he shall at once contact the authority inviting the tender for clarification before the submission of the offer.
- 1.1.6 Before tendering, the tenderer is advised to inspect the site of work and the environments and be well acquainted with the actual working and other prevalent conditions, facilities available, position of material and labour. No claim will be entertained later on the ground of lack of knowledge.
- 1.1.7 Tenderers must fill up all the schedules and furnish all the required information as per the instructions given in various sections of the tender specification. Each and every page of the Tender Specification & deceleration must be signed bearing seal and submitted along with the offers by the Tender in token of complete acceptance thereof. The information furnished shall be complete by itself. The booklet of G.S.C.C may be retained by the bidder if deceleration is enclosed along with the bid duly filled in and signed and sealed.
- 1.1.8 The tender shall quote the rates in English language and international numerals. The rates shall be in whole rupees. These rates shall be entered in figures as well as in words. For the purpose of the tender, the metric system of units shall be used.
- 1.1.9 All entries in the tender shall either be typed or be in ink. Erasures and overwriting are not permitted and may render such tenders liable to summary rejection. All cancellations and insertions shall be duly attested by the tenderer.
- 1.2 Qualifications of Tenderers:
Only tenderers who have previous experience in work of this nature and description detailed in this tender specification and/or registered with BHEL, PSER-SAS for such works are expected to quote for this work duly detailing their experience along with the offer. Offers from tenderers who do not have established experience in the field are not likely to be considered.



**GENERAL & SPECIAL CONDITIONS
OF CONTRACT [FOR SERVICES JOB]**

**PSER
KOLKATA**

1.3 Data to be enclosed:

Full information shall be given by the tender in respect of following. Non-submission of this information may lead to rejection of the offer/tender.

1.3.1 Financial Status:

- a) A certificate from BHEL's scheduled Bank to prove his financial capacity/capability to undertakes the work of solvency certificate from the concerned Government Authority.
- b) Contractors other than those who are registered in ER, should submit their audited annual accounts for three years preceding the financial year in which tenders are called for.

1.3.2 Income Tax / Sales Tax Certificate :

A certificate of Income Tax / Sales Tax verification from the appropriate authority in the forms prescribed therefor duly indicating annual turnover. The certificates shall be valid for one year from the date of issue or for the period prescribed therein for all tenders submitted during the period.

1.3.3 Previous Experience:

A statement giving particulars duly supported by documentary evidence of the various services rendered for each similar work by the tenderer indicating the particulars and value of each work, the site location and the duration and date of completion and also a list of site locations and particulars and value of various services that are under progress.

1.3.4 Organisation Chart:

The organisation pattern that is totally available with the tenderer and that will be employed by the tenderer for this work duly indicating the number of Engineers and Supervisors, their qualification and experience in the line, the number of skilled and unskilled workmen etc.

1.3.5 An attested copy of the Power of Attorney, in case the tender is signed by an individual other than the sole proprietor, shall also be attached.

1.3.6 In case of an individual:

His full name, address and place and nature of business.

1.3.7 In case of Partnership firms:

The name of all the partners and their addresses. A copy of the Partnership Deed (Instrument of partnership) duly certified by the Notary Public shall be enclosed.

1.3.8 In case of Companies:

Date and place of registration including Date of Commencement Certificate in case of public companies (certified copies of Memorandum and Articles of Associations are also to be furnished).



**GENERAL & SPECIAL CONDITIONS
OF CONTRACT [FOR SERVICES JOB]**

**PSER
KOLKATA**

- 1.3.9 Nature of business carried on by the Company and the provision of the Memorandum relating thereof.
- 1.3.10 Names and particulars including addresses of all the Directors and their previous experience.
- 1.3.11 A list of tools and tackles that the tenderer is having and those that will be earmarked for this job.
- 1.3.12 In addition to the above, the particulars required in various annexures.

1.4 EARNEST MONEY DEPOSIT (EMD):

- 1.4.1 Every tender Must be accompanied by the prescribed amount of Earnest Money Deposit in any one of the following forms:
- 1.4.1.1 **Cash deposit as permissible under the extant Income Tax Act** (Before tender opening) - The amount should be remitted by the party to the Cashier of Bharat Heavy Electricals Limited, PS-ER, Kolkata between 14.00 hours and 16.00 hours on working days and cash receipt issued by him shall be enclosed along with the tender.
- 1.4.1.2 **Electronic Fund Transfer** credited in Bharat Heavy Electricals Limited, PS-ER' account (before tender opening). RTGS details of BHEL-PSER is available in tender.
- 1.4.1.3 **Banker's Cheque/Pay Order/Demand Draft** payable at Kolkata duly pledged in Favour of Bharat Heavy Electricals Limited, Kolkata (along with offer).
- 1.4.1.4 **Fixed Deposit Receipt (FDR)** issued by Scheduled Banks/ Public Financial Institutions as defined in the Companies Act (FDR should be in the name of the Contractor, a/c BHEL).
- 1.4.1.5 **Any other mode as per latest guidelines issued by Govt. of India.**

In addition to above, the EMD amount in excess of Rs. 2 Lakh may also be accepted in the form of Bank Guarantee from scheduled bank. The Bank Guarantee in such cases shall be valid for atleast six months.

- 1.4.1.6 Parties/bidders who have submitted/submits **One Time EMD (OEMD) in this Power Sector Region (i.e. BHEL-PSER) for Service After Sales (SAS) a sum of amount Rs. 5,00,000/- (Rupees Five Lakh only)** are exempted from payment of E.M.D. on each such tender in that unit on case to case basis.
- 1.4.2 Tenders received without Earnest Money in full in the manner prescribed above are liable to be rejected. EMD shall not carry any interest.
- 1.4.3 The Earnest Money Deposit of the successful tenderer will be retained as part of Security Deposit.
- 1.4.4 EMD given by all unsuccessful tenderers shall be refunded normally within 15 days of award of work.
- 1.4.5 BHEL reserves the right of forfeiture of Earnest Money Deposit submitted by the tenderer if:-
- After opening the tender and within the offer validity period, the tenderer revokes his tender or makes any modification in his tender which is not acceptable to BHEL.
 - The Contractor fails to deposit the required Security Deposit or commence the work within the period as per LOI/Contract.

EMD by the tenderer shall be withheld in case any action on the tenderer is envisaged under the provisions of extant "Guidelines on Suspension of business dealings with suppliers/contractors" and forfeited/released based on the action as determined under these guidelines".



**GENERAL & SPECIAL CONDITIONS
OF CONTRACT [FOR SERVICES JOB]**

**PSER
KOLKATA**

1.5 Authorisation and Attestation:

1.5.1 Tenders shall be signed by persons duly authorised/empowered to do so. Certified copies of such authority and relevant documents shall be submitted along with the tenders.

1.6 Validity of Offer:

The rates in the tender shall be kept open for acceptance for a minimum period of six months from the due date of opening of tenders. If a tenderer withdraws or revokes his tender or increases the tender rates and/or conditions for any item within the aforesaid period, his Earnest Money Deposit is liable to be forfeited. In case the Bharat Heavy Electricals Limited calls for negotiations, such negotiation shall not amount to cancellation or withdrawal of the original offer which shall be binding on the tenderers.

1.7 Execution of Contract:

The successful tender's responsibility under this contract commences from the date of issue of the Letter of Intent by Bharat Heavy Electricals Limited. The successful tenderer may be required to execute an agreement in the prescribed form with the BHEL within a reasonable time after the acceptance of his tender and in any case before submitting first RA bill for payment. The expenses for completing and stamping the agreement shall be borne by the tenderer.

1.8 Security Deposit (SD):

1.8.1 Security Deposit means the security provided by the contractor towards fulfilment of any obligations in terms of the provisions of the contract. Upon acceptance of tender, the successful tenderer within the time specified in the Letter of Intent must deposit the required amount towards Security Deposit before start of the work. The Security Deposit shall not carry any interest.

1.8.2 The total amount of **Security Deposit will be 3% (Three per cent)** of the contract value. EMD of the successful tenderer shall be converted and adjusted towards the required amount of Security Deposit.

1.8.3 If the value of the work done at any time exceeds the accepted agreement value, the Security Deposit shall be correspondingly enhanced and the additional Security Deposit shall immediately be deposited by the contractor or recovered from payments due to the contractor.

1.8.4 Regarding adjustment of Earnest Money Deposit towards part of Security Deposit, refer clause 1.8.2 above, the successful tenderer shall not commence any work under the contract before remitting the Security Deposit except as directed by BHEL.

1.8.5 Failure to deposit the Security within the stipulated time may lead to forfeiture of Earnest Money and cancellation of the award of work.

1.8.6 The balance amount to make up the required Security Deposit of 3% of the contract value may be furnished in any one of the following forms:

- i) Cash (as permissible under the Income Tax Act)
- ii) Local cheques of scheduled banks (subject to realization)/Pay Order/Demand Draft/Electronic Fund Transfer credited in Bharat Heavy Electricals Limited, PS-ER' account.



**GENERAL & SPECIAL CONDITIONS
OF CONTRACT [FOR SERVICES JOB]**

**PSER
KOLKATA**

- iii) Bank Guarantee from Scheduled Banks / Public Financial Institutions as defined in the Companies Act. The Bank Guarantee format should have the approval of BHEL. Bank Guarantee for S.D. must be posted by the Bank by registered post directly to us, and it should not be submitted by the bidder directly to us.
- iv) Fixed Deposit Receipt issued by Scheduled Banks / Public Financial Institutions as defined in the Companies Act (FDR should be in the name of the contractor, A/C BHEL).
- v) Securities available from Indian Post Offices such as National Savings Certificates, Kisan Vikas Patras etc. (held in the name of Contractor furnishing the security and duly endorsed/hypothecated/ pledged, as applicable, in favour of BHEL).
- vi) Any other mode as per latest guidelines issued by Govt. of India.

Note: BHEL will not be liable or responsible in any manner for the collection of interest or renewal of the documents or in any other matter connected therewith.

1.8.7 Collection of Security Deposit:

- 1.8.7.1 At least 50% of the required Security Deposit, including EMD, should be collected before start of work. Balance of the Security Deposit can be collected by deducting 10% of the gross amount progressively from each of the running bills of the contractor till the amount of the required Security Deposit is collected.
- 1.8.7.2 If the value of the work done at any time exceeds the accepted agreement value, the Security Deposit shall be correspondingly enhanced and the additional Security Deposit shall immediately be deposited by the contractor or recovered from payments due to the contractor.
- 1.8.7.3 The recoveries made from running bills (cash deduction towards balance SD amount) can be released against submission of equivalent Bank Guarantee in acceptable form, but only once, before completion of work, subject to approval of BHEL.
- 1.8.7.4 In case of SAS jobs, work can be started before the required Security Deposit is collected. However, payment can be released only after collection/recovery of initial 50% Security Deposit.
- 1.8.8 BHEL reserves the right of forfeiture of Security Deposit in addition to other claim and penalties in the event of the contractor's failure to fulfil any of the contractual obligations including statutory or in the event of termination of contract as per terms and conditions of contract.
- 1.8.9 DELETED.
- 1.8.10 No interest shall be payable by BHEL on Earnest Money / Security Deposit or any money due to the contractor from BHEL.
- 1.8.11 In no case Security Deposit can be released before settling all claims under this contract.



**GENERAL & SPECIAL CONDITIONS
OF CONTRACT [FOR SERVICES JOB]**

**PSER
KOLKATA**

1.9 Rejection of Tender and other conditions:

1.9.1 The acceptance of tender will rest with BHEL which does not bind itself to accept the lowest tender or any tender and reserves to itself full rights for the following without assigning any reasons whatsoever:

- a) to reject any or all of the tenders.
- b) To split up the work amongst two or more tenderers.
- c) To award the work in part.
- d) Either of the contingencies stated in (b) and (c) to modify the time for completion suitably.
- e) To modify the scope of work after mutual agreement.

1.9.2 Conditional and unwitnessed tenders:

Tenders containing absurd or unworkable rates and amounts and tenders which are incomplete and otherwise considered defective and tenders not in accordance with the tender conditions, specifications etc. are liable to be rejected.

1.9.3 If a tenderer expires after his submission of the tender or after the acceptance of his tender, BHEL may at their discretion, cancel such tender. If a partner of a firm expires after the submission of the tender or after the acceptance of the tender, BHEL may cancel such tender at their discretion unless the firm retains its character.

1.9.4 BHEL will not be bound by any Power of Attorney granted by the tenderer or by changes in the compositions of the firm made subsequent to the execution of the contract. They may, however, recognise such power of Attorney and changes after obtaining proper legal advice, the cost of which will be chargeable to the contractor concerned.

1.9.5 If the tenderer deliberately gives wrong information in his tender, BHEL reserves the right to reject such tender at any stage or to cancel the contract, if awarded and forfeit the Earnest Money/Security Deposit.

1.9.6 Canvassing in any form in connection with the tenders is strictly prohibited and the tenders submitted by the contractor who resort to canvassing are liable to rejection.

1.9.7 Should a tenderer or contractor or in the case of a firm or Company of Contractors one or more of its Partners/shareholders/Directors have a relation or relations employed in the capacity of an officer of BHEL, the authority inviting tender shall be informed of the fact along with the offer, failing this, BHEL may at its sole discretion, reject the tender or cancel the contract and forfeit the Earnest Money/Security Deposit.

1.9.8 The successful tenderer should not sub-contract the part or complete work detailed in this tender specification undertaken by him without permission of BHEL. The tenderer is solely responsible to BHEL for the work awarded to him. Any deviation in this regard will entail termination of such contract by BHEL at the risk and responsibility of contractor.

1.9.9 The successful tenderer shall inform/keep BHEL informed if he has already undertaken any work/is likely to be awarded any job with the same customer with whom BHEL is entering into contract.



**GENERAL & SPECIAL CONDITIONS
OF CONTRACT [FOR SERVICES JOB]**

**PSER
KOLKATA**

SECTION – II

GENERAL TERMS & CONDITIONS OF THE CONTRACT

2.1 Definition:

The following terms and expressions shall have the meaning hereby assigned to them except where they context otherwise requires:

- 2.1.1 'BHEL' (or B.H.E. Ltd.) shall mean Bharat Heavy Electricals Limited, a company registered under Indian Companies Act., 1956, with its Registered Office at BHEL House, SIRI FORT, NEW DELHI-110049, Power Sector, Eastern Region, Service After Sales – Services, DJ-9/1, Salt Lake, Kolkata – 700091 or its Administrative officers or its site Engineer or the employees authorised to deal with any matters with which these persons are concerned on its behalf.
- 2.1.2 "GENERAL MANAGER"/DEPUTY IN CHARGE" shall mean the Officer in Administrative charge of BHEL, PS-ER, SAS – Services, Kolkata or their other regional offices.
- 2.1.3 "ENGINEER" or "ENGINEER IN CHARGE" shall mean Engineer deputed by BHEL. The terms include "SITE ENGINEER", "RESIDENT ENGINEER" and "ASSISTANT SITE ENGINEER" of BHEL at the site as well s the officers in-charge at Kolkata office.
- 2.1.4 "SITE" shall mean the place or places at which the plants/equipment are to be overhauled and services are to be performed as per the specification of this contract.
- 2.1.5 "CLIENTS OF BHEL" or "CUSTOMER" shall mean the Project authorities to whom BHEL is supplying the equipment/services.
- 2.1.6 "CONTRACTOR" shall mean the individual, firm or company who enters into this contract with BHEL and shall include their executors, administrators, successors and permitted assigns.
- 2.1.7 "CONTRACT" or "CONTRACT DOCUMENT" shall mean and include the agreement or work order, the accepted appendices of rates, schedule of quantities, if any and general condition of contract, the special conditioning of contract instructions of the tenderers, the drawings, the specifications, the special specification, if any, the tender specifications, the special specification, if any, the tender documents and the Letter of Intent/Accepting Letter issued by BHEL. Any conditions or terms stipulated by the contractor in the tender documents or supporting letters shall not form part of the contract unless specifically accepted in writing by BHEL and incorporated in the agreement.
- 2.1.8 "GENERAL CONDITIONS OF CONTRACT" shall mean the instructions to tenderers and general conditions of contract pertaining to the work detailed.
- 2.1.9 "TENDER SPECIFICATION" shall mean the "Specific Conditions, technical specifications, appendices, site information and drawings, "pertaining to the work for which the tenderers are required to submit their offer. Also this will include the specifications detailed in NIT of client of BHEL for overhauling, erection, testing and commissioning of plant. Individual specification no. will be assigned to each tender specification.



**GENERAL & SPECIAL CONDITIONS
OF CONTRACT [FOR SERVICES JOB]**

**PSER
KOLKATA**

- 2.1.10 "TENDER DOCUMENTS" shall mean the General conditions of contract (2.1.8) and tender specification (2.1.9)
- 2.1.11 "LETTER OF INTENT" shall mean the intimation by a letter to the tenderer that the tender has been accepted in accordance with provisions contained in that letters. The responsibility of the contractor commences from the date of issue of this letter and all the terms and conditions of contract are applicable from this date.
- 2.1.12 "COMPLETION TIME" shall mean the period by date specified in the acceptance of tender for handing over the overhauled equipment/plant which are found acceptable by the engineer being of required standard and conforming to the specification of the contract or recommissioning of the machine successfully whichever is later. Completion time will be reckoned from the date of LOI with the period for mobilisation as prided with LOI, added to the same.
- 2.1.13 "PLANT" shall mean and cannot the entire assembly of the plant and equipments covered by the contract.
- 2.1.14 "EQUIPMENT" shall mean all equipments, machineries, materials, structurals, electricals and other components of the plant covered by the contract.
- 2.1.15 "TESTS" shall mean and include such test or tests to be carried out on the part of the contractor as are prescribed in the contract or considered necessary by BHEL, in order to ascertain the quality workmanship, performance and efficiency of the contract work or part thereof.
- 2.1.16 "APPROVED" "DIRECTED" or "INSTRUCTED" shall mean approved, directed or instructed by BHEL.
- 2.1.17 "WORK OR CONTRACT WORK" shall mean and include supply of all categories of labour, specified consumables, tools and tackles required for complete and satisfactory site transportation, handling, stacking, storing, overhauling erection, testing and commissioning of the equipment to the entire satisfaction of BHEL.
- 2.1.18 "SINGULAR AND PLURAL ETC" words carrying singular number shall also include plural and vice versa, where the context so requires, words importing the masculine gender shall be taken to include any company or Association or body of individuals, whether incorporated or not.
- 2.1.19 "HEADINGS" The Leadings in these general conditions are solely for the purpose of facilitating reference and shall not be deemed to be part thereof or be taken into consideration in interpretation or construction thereof or of the contract.
- 2.1.20 "MONTH" shall mean calendar month.
- 2.1.21 "WRITING" shall include any manuscript, type written or printed statement under the signature or seal as the case may be.
- 2.2 Law governing the contract and Court Jurisdiction:

The contract shall be governing by the Law for the time being in force in the Republic of India. The Civil Court having ordinary original civil jurisdiction, Kolkata shall alone have exclusive Jurisdiction in regard to all claims in respective of this contract.



**GENERAL & SPECIAL CONDITIONS
OF CONTRACT [FOR SERVICES JOB]**

**PSER
KOLKATA**

2.3 Issue of Notice:

The contractor shall furnish to the BHEL Engineer the name, designation and address of his authorised agent and all complaints, notices, communications and reference shall be deemed to have been duly given to the contractor if delivered to the contractor or his authorised agent or left at or posted to the address either of the contractor or of his representative and shall be deemed to have been so given in the case of posting on the day on which they would have reached such address in the ordinary course of past or on which they were so delivered or/or left.

2.4 Use of Land:

No land belonging to BHEL or their customer, under temporary possession of BHEL shall be occupied by the contractor without the written permission of BHEL.

2.5 Commencement of Work:

2.5.1 The contractor shall commence the work within the time indicated in the Letter of Intent from BHEL and shall proceed with the same with due expedition without delay. For computing the scheduled completion date, commencement, of work will be reckoned from the date of complete mobilisation as per LOI, unless specifically amended by Head (Services), BHEL, Kolkata.

2.5.2 If the successful tenderer fails to start the work within the stipulated time, BHEL as its discretion will have the right to cancel the contract. His Earnest Money and / or Security Deposit with BHEL will stand forfeited without any further reference to him, without prejudice to any and all of BHEL's other rights and remedies in this regard.

2.5.3 All the works shall be carried out under the direction and to the satisfaction of BHEL.

2.5.4 The erected overhauled plant or work performed under the contract shall be taken over when it has been completed in all respects and or satisfactorily put into operation at site.

2.6 Mode of payment and measurement of the work completed.

2.6.1 "All payment due to the contractor shall be paid only by Account payee Cheques"

2.6.2 The contractor shall present his bill on the format prescribed by BHEL for every payment. After verification of such bills by BHEL, all items having financial value shall be entered and certified in BHEL Measurement Book by BHEL Engineer and the bills prepared based on the same and connected technical documents which form part of this tender specification.

2.6.3 Lump sum omission will be entered for deduction. Measurement shall be restricted to that for which it is required to ascertain the financial liability of BHEL under this Contract.

2.6.4 Work which is to be measured in details shall be measured as per standard procedure without reference to any local procedures without reference to any local procedures excepting where it is otherwise stated in the tender documents. The measurement shall be taken jointly by person duly authorised on the part of BHEL and by the contractor.



**GENERAL & SPECIAL CONDITIONS
OF CONTRACT [FOR SERVICES JOB]**

**PSER
KOLKATA**

- 2.6.5 If, at any time due to reason whatsoever, it becomes necessary to remeasure the work done in full or in part, the expenses towards such remeasurement shall be borne by the contractor.
- 2.6.6.1 The contractor shall bear the expenditure involved, if any, in making the measurement. The Contractor shall, without extra charges, provide all the assistance with appliances with appliance and other things necessary for measurement.
- 2.6.7 The measurement entered in the Measurement Books and the bills prepared shall be signed and dated by both the contracting parties.
- 2.6.8 The Contractor will be intimated in writing by the site Engineer, the proposed date of measurement. If the contractor, representative fails to participate in the joint measurement, the BHEL engineer shall have the power to proceed by himself to take measurement in which case the measurement shall be accepted by the contractor as final.
- 2.6.9 Passing of measurement as per bills does not amount to acceptance of the completion of work mentioned. Any left out work has to be completed if pointed out at a later date by BHEL.

2.7 Rights of BHEL:

- 2.7.1 To withdraw any portion of work and/or to restrict / alter the quantum of work as indicated in the contract during the progress of work and get it done through other agency and/or by departmental labour to suit BHEL's commitment to its customer or in case BHEL decides to advance the date of completion due to other emergency reasons / BHEL's obligation to its customer.
- 2.7.2 To terminate the contract or withdraw portion of work and get it done through other agency, at the risk and cost of the contractor after due notice of a period of 14 days' by BHEL in any of the following cases:
- i) Contractor's poor progress of the work vis-à-vis execution timeline as stipulated in the Contract, backlog attributable to contractor including unexecuted portion of work does not appear to be executable within balance available (#) period considering its performance of execution.
 - ii) Withdrawal from or abandonment of the work by contractor before completion of the work as per contract.
 - iii) Non-completion of work by the Contractor within scheduled completion period as per Contract or as extended from time to time, for the reasons attributable to the contractor.
 - iv) Termination of Contract on account of any other reason (s) attributable to Contractor.
 - v) Assignment, transfer, subletting of Contract without BHEL's written permission.
 - vi) Non-compliance to any contractual condition or any other default attributable to Contractor.
- (#) In-case inputs from BHEL/Customer are likely to be delayed or are actually delayed, this delay may also be taken into account while considering balance period available for execution of Contract.

Risk & Cost Amount against Balance Work:

Risk & Cost amount against balance work shall be calculated as follows:

$$\text{Risk \& Cost Amount} = [(A-B) + (A \times H/100)]$$

Where,

A= Value of Balance scope of Work (*) as per rates of new contract

B= Value of Balance scope of Work (*) as per rates of old contract being paid to the contractor at the time of termination of contract i.e. inclusive of PVC & ORC, if any.

H = Overhead Factor to be taken as 5

In case (A-B) is less than 0 (zero), value of (A-B) shall be taken as 0 (zero).



**GENERAL & SPECIAL CONDITIONS
OF CONTRACT [FOR SERVICES JOB]**

**PSER
KOLKATA**

(* Balance scope of work (in case of termination of contract):

Difference of Contract Quantities and Executed Quantities as on the date of issue of Letter for 'Termination of Contract', shall be taken as balance scope of Work for calculating risk & cost amount. Contract quantities are the quantities as per original contract. If, Contract has been amended, quantities as per amended Contract shall be considered as Contract Quantities.

Items for which total quantities to be executed have exceeded the Contract Quantities based on drawings issued to contractor from time to time till issue of Termination letter, then for these items total Quantities as per issued drawings would be deemed to be contract quantities.

Substitute/ extra items whose rates have already been approved would form part of contract quantities for this purpose. Substitute/ extra items which have been executed but rates have not been approved, would also form part of contract quantities for this purpose and rates of such items shall be determined in line with contractual provisions.

However, increase in quantities on account of additional scope in new tender shall not be considered for this purpose.

NOTE: In-case portion of work is being withdrawn at risk & cost of contractor instead of termination of contract, contract quantities pertaining to portion of work withdrawn shall be considered as 'Balance scope of work' for calculating Risk & Cost amount.

LD against delay in executed work in case of Termination of Contract:

LD against delay in executed work shall be calculated in line with LD clause as per GCC/SCC/TCC/Special note/any other annexure of tender document (in compliance with order of precedence), for the delay attributable to contractor. For limiting the maximum value of LD, contract value shall be taken as Executed Value of work till termination of contract.

Method for calculation of "LD against delay in executed work in case of termination of contract" is given below.

- i) Let the time period from scheduled date of start of work till termination of contract excluding the period of Hold (if any) not attributable to contractor = T1
- ii) Let the value of executed work till the time of termination of contract = X
- iii) Let the Total Executable Value of work for which inputs/fronts were made available to contractor and were planned for execution till termination of contract = Y
- iv) Delay in executed work attributable to contractor i.e. $T2 = [1 - (X/Y)] \times T1$
- v) LD shall be calculated in line with LD clause [as per GCC/SCC/TCC/Special note/any other annexure of tender document (in compliance with order of precedence)] of the Contract for the delay attributable to contractor taking "X" as Contract Value and "T2" as period of delay attributable to contractor.

2.7.3 Recoveries arising out of Risk & Cost and LD or any other recoveries due from Contractor

Following sequence shall be applicable for recoveries from contractor:

- a) Dues available in the form of Bills payable to contractor, SD, BGs against the same contract.
- b) Demand notice for deposit of balance recovery amount shall be sent to contractor, if funds are insufficient to effect complete recovery against dues indicated in (a) above.
- c) If contractor fails to deposit the balance amount to be recovered within the period as prescribed in demand notice, following action shall be taken for balance recovery:
 - i) Dues payable to contractor against other contracts in the same Region shall be considered for recovery.
 - ii) If recovery cannot be made out of dues payable to the contractor as above, balance amount to be recovered, shall be informed to other Regions/Units for making recovery from the Unpaid Bills/Running Bills/SD/BGs/Final Bills of contractor.
 - iii) In-case recoveries are not possible with any of the above available options, Legal action shall be initiated for recovery against contractor.

2.7.4 To terminate the contract or to restrict the quantum of work and pay for the portion of work executed in case BHEL's contract with their customers are terminated for any reason.



**GENERAL & SPECIAL CONDITIONS
OF CONTRACT [FOR SERVICES JOB]**

**PSER
KOLKATA**

- 2.7.5 While every endeavour will be made by BHEL they cannot guarantee uninterrupted work due to conditions beyond their control. Contractor will not be entitled to any compensation / extra payment on this account.
- 2.8 Responsibilities of the Contractor:
The following are the responsibilities of the contractor in respect of observation of local laws, employment of personnel, payment of taxes and execution of job etc.
- 2.8.1 As far as possible, unskilled workers shall be engaged from the local areas in which the work is being executed.
- 2.8.2 The Contractor at all times during the continuance of this contract, shall in all his dealing with local labour for the time being employed on or in connection with the work, have due regard to all local festivals and religious and other customs.
- 2.8.3 The contractor shall comply with all state and central Laws, Statutory Rules, Regulations etc., such as:
The payment of wages Act, Minimum Wage Act, Workmen compensation Act, Employers Liability Act, Industrial Disputes Act, Employees Provident Fund Scheme, Employees Insurance Scheme, Contract Labour (Regulation & Abolition) Act 1970 and other Acts, Rules & Regulations for labour as may be enacted by the Government during the tenure of the Contract and having force or jurisdiction at site. The Contractor shall give to the local Governing Body, Police and other relevant authorities all such notices as may be required by law.
- 2.8.4 The Contractor shall pay all taxes, fees, licence charges, deposits duties, tools, royalty, commission or other charges which may be leviable on account of any of his operations in executing the contract. In case, BHEL is forced to pay any of such taxes, BHEL shall have the right to recover the same from the contractor either from his bills or otherwise as deemed fit.
- 2.8.5 The Contractor shall be responsible for provision of health and sanitary arrangements, more particularly described in contract Labour (Regulation & Abolition Act) safety precautions etc., as may be required of same and satisfactory execution of the contract.
- 2.8.6 The contractor shall fulfil all his obligation in respect of accommodation including proper medical facilities for the personnel employed by him.
- 2.8.7 The contractor shall be responsible for the proper behaviour at site and observance of all regulations by the staff employed by him.
- 2.8.8 The Contractor shall ensure that no damage is caused to any person / property of other parties working at site. If any such damages is caused, it is the responsibility of the contractor to make the losses or compensate for the same.
- 2.8.9 All the properties / equipments / components of BHEL / their client loaned with or without deposit to the contractor in connection with the contract shall remain the properties of BHEL / their client. The Contractor shall use such properties for the purpose of execution of this contract. All such properties / equipment / components shall be deemed to be in good condition when received by the contractor unless he notified within 48 hours to the contrary. The Contractor shall return them in good conditions as and when required by BHEL / their client. In case of non-return, loss damage, repairs, etc. the cost thereof, as may be fixed by the site Engineer, will be recovered from the contractor.



**GENERAL & SPECIAL CONDITIONS
OF CONTRACT [FOR SERVICES JOB]**

**PSER
KOLKATA**

- 2.8.10 It is not obligatory on the part of BHEL to supply any tools and tackles or other materials other than those specifically agreed to do so by BHEL. However, depending upon the availability / possibility BHEL's customers' handling equipment and other plants may be made available to the contractor on payment of the hire charges / free of charges as fixed, subject to the condition laid down by BHEL. Customer form time to time, Unless paid in advance, such hire charges if applicable shall be recovered from contractor's bill / security Deposit in one instalment.
- 2.8.11 The contractor shall not claim any compensation of the scope of the work, due to changes in design which curtails quantum.
- 2.8.12 The Contractor shall fully indemnify BHEL against all claims of whatsoever nature arising during the course of erection / overhauling / performing work under the contract.
- 2.8.13 In case the contractor is required to undertake any major work outside the scope of this contract the rates payable shall be decided by BHEL Resident Engineer.
- 2.8.14 The contractor shall keep the area of work clean and shall remove debris etc., while executing day to day work. Upon completion of work, the contractor shall remove from the vicinity of work, all scrap, packing materials, rubbish, unused and other materials and deposit them in places to be specified by the BHEL Engineer. The contractor will also demolish all hutments, sheds, partitions, offices, constructed and used by him and shall clean the debris. In the event of his failure to do so, the same will be arranged to be removed by the BHEL. The expenses thereof will be recovered from contractor.
- 2.8.15 The contractor shall arrange and co-ordinate his work in such a manner as to cause no inconvenience to other agencies working in the area.
- 2.8.16 All safety rules and codes applied by the client / BHEL at site shall be observed by the contractor without exception. The contractor shall be responsible for the safety of the equipment / material and work to be performed by him and shall maintain all light, fencing guards, signs etc. or other protection necessary for the purpose. Contractor shall also take such additional precautions as may be indicated from time to time by the Engineer with a view to prevent pilferage, accidents, fire hazards and atmospheric conditions. Suitable number of electrical staff, watch and ward, store keepers to take care of the equipment, materials and construction tools and tackles, shall be posted at site by the contractor till completion of the work under this contract. The contractor shall arrange for such safety devices as are necessary for such type of work and carry out the requisite tests of handling equipment, lifting tools, tackles etc, as per prescribed standards and practices.
- 2.8.17 The contractor will be directly responsible for payment of wages to his women. A pay roll sheet giving all the payments given to workers and duly signed by the contractor's representative should be furnished to BHEL site office for record purpose. BHEL site In-charge may be intimated the date of disbursement of wages to the workmen engaged for the work, so that his representative can witness the same.
- 2.8.18 The intent of specification, is to provide services according to most modern and proven techniques and codes. The omission of specific reference to any method, requirement or material necessary for the proper and efficient performance of work shall not relieve the contractor of the responsibility of providing such facilities to complete the work.



**GENERAL & SPECIAL CONDITIONS
OF CONTRACT [FOR SERVICES JOB]**

**PSER
KOLKATA**

- 2.8.19 In case of any clause of the work for which there is no such specification as laid down in the contract, such work shall be carried out in accordance with the instructions and requirements of the BHEL Engineer.
- 2.8.20 No levy or payment or charge made or imposed shall be impeached by reason of any clerical error or by reason of any mistake in the amount levied or demanded or charged.
- 2.8.21 The details drawings, specifications, instructions manual, if any available with the BHEL Engineer will form part of tender specification. These documents will be made available for reference only to the contractor during execution of work.
- 2.8.22 Should any error or ambiguity be discovered in the specification or information, the contractor shall forthwith bring the same to the notice of BHEL before commencement of work. BHEL's interpretation in such cases shall be final and binding on the contractor.
- 2.8.23 No idle labour charges will be admissible in the event of any stoppage caused in the work resulting in contractor's labour being rendered idle due to any cause of any type.
- 2.8.24 **No over run charges shall be paid in the event of the completion period being extended for any reason whatsoever.**
- 2.8.25 It is possible that some repair/rectification, modification may be needed on the equipments to be overhauled / work to be performed under this specification, for reasons not attributions to the contractor. All such repair / rectification / modification work which can be done, with the available facilities at site shall be carried out by the contractor free of cost and no extra charges shall be paid to contractor.
- 2.8.26 The quality and progress of work will be regularly reviewed. The schedule and progress of work will be given to the contractor in advance and it will be the obligation / responsibility of the contractor to achieve the desired quality and progress of work by suitably reinforcing their labour force and/or by working extra hours or in more than one shift without any extra cost. Workmen found unsuitable for the work will be replaced immediately by the contractor on being informed by BHEL.
- 2.8.27 During the overhauling work under the contract it is very essential that proper and adequate inspection should made constantly to maintain the quality or workmanship so that any deviation from design dimension does not exceed permissible limits. The proper functioning of the unit, while in operation, depends to a great extent on the above factors. The fact that effective supervision and inspection at the execution stage is less costly than any down time of running unit even for a short period need not be over emphasized. For the details regarding alignment and permissible dimensional deviations in the sub-assemblies BHEL Engineer may be consulted.
- 2.8.28 The contractor shall be furnish fortnightly labour report showing by classification of number of employees engaged in various categories or work date wise and submit a progress report of work as required by BHEL Engineer.
- 2.8.29 The contractor shall execute the work in the most substantial and workmen-like manner in stipulated time. Accuracy of work and timely execution are the essence of this contract. The contractor shall be responsible to ensure that the assembly and workmanship conform to the dimensions and clearances given in the drawings and/or as per instructions of BHEL Engineers.
- 2.8.30 The contractor shall take all responsible care to protect the materials and work till such time the plant/equipment has been taken over by BHEL / their client. Where necessary, suitable temporary fencing and lighting shall have to be provided by the contractor as a safety measure against accident and damage of property of BHEL. Suitable caution notice shall be displayed where access to any part may be deemed to be unsafe and hazardous.
- 2.8.31 It will be the responsibility of the contractor to ensure safe lifting of the equipments taking due precautions to avoid any accidents and damage to other equipments and personnel.
- 2.9 **Void**



**GENERAL & SPECIAL CONDITIONS
OF CONTRACT [FOR SERVICES JOB]**

**PSER
KOLKATA**

2.10 Insurance:

2.10.1 BHEL / their customer shall arrange for insuring the materials / properties of BHEL/customer covering risks during transit, storage, overhauling, erection and commissioning.

2.10.2 It is the sole responsibility of the contractor to insure his workman against accident and injury while at work as required by relevant rules and to pay compensation, if any, to workmen as per workmen's compensation Act. Contractor shall insure his staff against accidents. The work will be carried out in a protected area and all the rules and regulations of the client / BHEL in the area of project which are in force from time to time, will have to be followed by the contractor.

2.10.3 If due to negligence and /or non-observations of safety and other precautions, any accident / injury occurs to any other person/public, the Contractor shall have to pay necessary compensation and other expenses, if so decided by the appropriate authorities. Third party insurance coverage is to be made by the contractor.

2.10.4 If due to contractor's carelessness, negligence or non-observance of safety precautions damage to BHEL's /Customer's property and personnel should occur, and if BHEL is unable to recover, in full, cost from the Insurance Company, the balance will be recovered from the Contractor.

2.11 Strikes & Lockouts :

The contractor will be fully responsible for all the disputes and other issues connected with his labour. In the event of the contractor's labour resorting to strike or the lockout declared is not settled within a period of one week BHEL shall have the right to get the work executed employing the own labour or through any other agencies or both and the cost so incurred by BHEL, shall be deducted from the contractor's bills as per clause 2.7. For all purposes whatsoever, the employees of the contractor shall not be deemed to be in the employment of BHEL.

2.12. Force Majeure :

2.12.1 The following shall amount to Force Majeure :

Acts of God, Acts of any Government, war, sabotage, riots, civil commotion, police action, revolution, flood, fire, cyclones, earthquake and epidemic and other similar causes over which the contractor has no control.

2.12.2 If the contractor suffers delay in the due execution of the contractual obligation due to delays caused by Force Majeure as defined above, the agreed time of completion of the job covered by this contract or the obligations of the Contractor shall be extended by a period of time equal to the period of delay provided that on the occurrence of any such contingency the Contractor immediately reports to BHEL in writing the causes of delay and the contractor shall not be eligible for any compensation.

2.13 Performance Guarantee:

Even though the work will be carried out under supervision of BHEL Engineers. The contractor shall guarantee against defects attributable to faulty workmanship or procedure adopted in the overhaul for items covered in the contract for a period of six months from the date of re-commissioning of the set after the capital overhaul. The guarantee should cover all defects notified during this period and shall have to be attended to free of cost immediately or at the time our clients are able to give shut down of the set for the required period. when necessary. In case of failure of contractor to attend to such defects as and when required in time, BHEL shall arrange to attend the defects and the charges shall be levied to contractor's account and shall be recoverable from the security deposit / progressive payments.



**GENERAL & SPECIAL CONDITIONS
OF CONTRACT [FOR SERVICES JOB]**

**PSER
KOLKATA**

2.14. ARBITRATION & CONCILIATION:

2.14.1 ARBITRATION:

2.14.1.1 Except as provided elsewhere in this Contract, in case Parties are unable to reach amicable settlement (whether by Conciliation to be conducted as provided in Clause 2.14.2 herein below or otherwise) in respect of any dispute or difference; arising out of the formation, breach, termination, validity or execution of the Contract; or, the respective rights and liabilities of the Parties; or, in relation to interpretation of any provision of the Contract; or, in any manner touching upon the Contract (hereinafter referred to as the 'Dispute'), then, either Party may, commence arbitration in respect of such Dispute by issuance of a notice in terms of section 21 of the Arbitration & Conciliation Act, 1996 (hereinafter referred to as the 'Notice'). The Notice shall contain the particulars of all claims to be referred to arbitration in sufficient detail and shall also indicate the monetary amount of such claim. The arbitration shall be conducted by a sole arbitrator to be appointed by the Head of the BHEL Power Sector Region issuing the Contract within 60 days of receipt of the complete Notice. The language of arbitration shall be English.

The Arbitrator shall pass a reasoned award.

Subject as aforesaid, the provisions of Arbitration and Conciliation Act 1996 (India) or statutory modifications or re-enactments thereof and the rules made thereunder as in force from time to time shall apply to the arbitration proceedings under this clause. The seat of arbitration shall be Kolkata (the place from where the contract is Issued). The Contract shall be governed by and be construed as per provisions of the laws of India. Subject to this provision 2.14.1.1 regarding ARBITRATION, the principal civil court exercising ordinary civil jurisdiction over the area where the seat of arbitration is located shall have exclusive jurisdiction over any DISPUTE to the exclusion of any other court.

2.14.1.2 In case of Contract with Public Sector Enterprise (PSE) or a Government Department, the following shall be applicable:

In the event of any dispute or difference relating to the interpretation and application of the provisions of commercial contract(s) between Central Public Sector Enterprises (CPSEs)/ Port Trusts inter se and also between CPSEs and Government Departments/Organizations (excluding disputes concerning Railways, Income Tax, Customs & Excise Departments), such dispute or difference shall be taken up by either party for resolution through AMRCD (Administrative Mechanism for Resolution of CPSEs Disputes) as mentioned in DPE OM No. 4(1)/2013-DPE(GM)/FTS-1835 dated 22-05-2018 as amended from time to time.

2.14.1.3 The cost of arbitration shall initially be borne equally by the Parties subject to the final allocation thereof as per the award/order passed by the Arbitrator.

2.14.1.4 Notwithstanding the existence of any dispute or differences and/or reference for the arbitration, the Contractor shall proceed with and continue without hindrance the performance of its obligations under this Contract with due diligence and expedition in a professional manner unless the dispute inter-alia relates to cancellation, termination or short-closure of the Contract by BHEL.



**GENERAL & SPECIAL CONDITIONS
OF CONTRACT [FOR SERVICES JOB]**

**PSER
KOLKATA**

2.14.2 CONCILIATION:

If at any time (whether before, during or after the arbitral or judicial proceedings), any Disputes (which term shall mean and include any dispute, difference, question or disagreement arising in connection with construction, meaning, operation effect, interpretation or breach of the agreement, contract), which the Parties are unable to settle mutually, arise inter-se the Parties, the same may, be referred by either party to Conciliation to be conducted through Independent Experts Committee (IEC) to be appointed by competent authority of BHEL from the BHEL Panel of Conciliators.

Notes:

1. No serving or a retired employee of BHEL/Administrative Ministry of BHEL shall be included in the BHEL Panel of Conciliators.
2. Any other person(s) can be appointed as Conciliator(s) who is/are mutually agreeable to both the parties from outside the BHEL Panel of Conciliators.

The proceedings of Conciliation shall broadly be governed by Part-III of the Arbitration and Conciliation Act 1996 or any statutory modification thereof and as provided in Procedure 2.3 : "Procedure for conduct of conciliation proceedings" (as available in www.bhel.com). The Procedure 2.3: "Procedure for conduct of conciliation proceedings" (as available in www.bhel.com) together with its Formats (as available in www.bhel.com) will be treated as if the same is part and parcel hereof and shall be as effectual as if set out herein in this GCC.

The Contractor hereby agrees that BHEL may make any amendments or modifications to the provisions stipulated in the Procedure 2.3 : "Procedure for conduct of conciliation proceedings" (as available in www.bhel.com) from time to time and confirms that it shall be bound by such amended or modified provisions of the Procedure 2.3 : "Procedure for conduct of conciliation proceedings" (as available in www.bhel.com) with effect from the date as intimated by BHEL to it.

2.14.3 NO INTEREST PAYABLE TO CONTRACTOR:

Notwithstanding anything to the contrary contained in any other document comprising in the Contract, no interest shall be payable by BHEL to Contractor on any moneys or balances including but not limited to the Security Deposit, EMD, Retention Money, RA Bills or the Final Bill, or any amount withheld and/or appropriated by BHEL etc., which becomes or as the case may be, is adjudged to be due from BHEL to Contractor whether under the Contract or otherwise.



**GENERAL & SPECIAL CONDITIONS
OF CONTRACT [FOR SERVICES JOB]**

**PSER
KOLKATA**

SECTION – III
SPECIAL CONDITIONS OR CONTRACT

3.1 Quantum of Work:

3.1.1 The scope of work given in the tender specification is only approximate and is liable to variation and alternation at the discretion of BHEL Resident Engineer. No compensation on this account shall be payable to the contractor unless specifically recommended by BHEL Resident Engineer as the variation forming major additions to the original scope of work. All repair / rectification work arising out of normal wear and tear, seizure of parts etc. have to be done by the contractor and the same will be covered by the scope of work of the contract.

3.1.2 The scope of work details out the major activities only. However, as per the general maintenance requirement and site condition, certain related activities may have to be carried out without any extra cost.

3.2 Commencement and completion of work :

3.2.1 The starting time and completion time is the essence of the of the tender. As the time bound programme is firmly committed to customer, the starting time and completion time should be strictly adhered to. It will be not be possible to grant extension in completion time except in extraordinary circumstance, which will be decided entirely at the discretion of BHEL Resident Engineer. Work should normally be carried out in two shifts and sometimes also in three shifts in consultation with BHEL Resident Engineer.

A detailed programme of the various activities covered under this contract with specific time period to fall in the overall frame work of the above dates should be prepared and got approved by BHEL Resident Engineer. The progress against this programme shall be reviewed with BHEL Resident Engineer at the end of each day and critical areas identified and suitable steps taken in time.

If during the review, at any stage of overhauling, BHEL Resident Engineer feels that the delays are not likely to be made up, BHEL reserves the right to take corrective steps as considered necessary by BHEL Resident Engineer to complete work in scheduled time and debit the cost incurred thereon to the contractor. This does not however absolve the contractor of his own efforts in consultation with BHEL Resident Engineer. Every endeavour will be made to see that work proceeds uninterruptedly.

3.2.2 The tenderers should indicate the time required for starting the work once the letter of intent is issued and the time required for completion. The work may have to commence immediately after opening of the tenders. Hence, preference may be given to those tenderers who can commence the work earlier, and also ensure early completion.

3.2.3 The Contractor shall ensure completion of the job in all respects within the day from the date of commencement of work as given in contract.

3.3 Penalty for delay:

3.3.1 In the event of failure to complete the work in given time, an amount equal to ½% [half percent] of the contract value per day subject to a maximum of 10% [ten percent] of the contract value will be levied as penalty, in case the balance work is allowed to be completed by the contractor beyond the scheduled time of completion, which is at the discretion of BHEL. In case of delays on contractor's part, at any stage during the scheduled period or after, BHEL shall have the option of ensuring completion of the job by any other means at its disposal and the charges on this account shall be levied on the contractor. These shall be adjusted against contractor's bills or Security Deposit.

In case of LD recovery, the applicable GST shall also be recovered from vendor.



**GENERAL & SPECIAL CONDITIONS
OF CONTRACT [FOR SERVICES JOB]**

**PSER
KOLKATA**

3.4 Terms of Payment:

A minimum time of 15 days will be required for processing the bills and release of payment after the bills are presented to BHEL.

3.4.1 As per STC

All payments are subjects to income tax deductions @1% of the bill amount at source or as per Central Government Laws. No request for advance payment will be entertained by BHEL.

3.5 Inspection and Completion:

The work being carried out by the contractor will be supervised and inspected by our Site Engineers under the overall supervision of BHEL Resident Engineer.

3.6 The work will be deemed as complete when it is finally accepted by BHEL Resident Engineer and job completion certificate is issued. No extra payment will be made for any rework carried out by the contractor to rectify any defective work.

3.6 The contractor shall not be entitled for labour idling charges under any circumstances.

3.6 Tools, Tackles, Test Equipments & Consumables:

3.6.1 All tools and tackles and consumables required for day-to-day work like gas and gas cutting sets with accessories, AC/DC welding sets, TIG welding kits, welding cables, electrodes, all necessary power connection at his own cost. However, in case of emergency, BHEL may supply certain items if available, to contractor at actual cost plus handling charges, these will be deducted from contractors' running bills, testing equipment for conducting various tests, during the progress of overhauling / re-commissioning shall have to be provided by the contractor. Spare parts going into permanent installation shall only be provided by BHEL.

3.7 Accommodation for site staff and store space:

3.7.1 Contractor has to arrange for the stores and office at site; space for the same shall be made available as per the availability at site. The contractor shall be responsible to provide all necessary facilities like residential accommodation with sanitary facilities, transport, electricity, water, medical bonus etc. as required under various labour laws and statutory rules and regulations framed thereunder to the personnel employed by him.

3.8 Responsibilities of the contractor:

3.9 Supervisory staff and labour:

The contractor shall employ, specially skilled labour, supervisor and engineers thoroughly conversant with particular type of work to ensure quality work. BHEL reserves the right to decide on the suitability of the workers and other staff employed by the contractor. BHEL reserves the right to insist on removal of any employees of the contractor at any time if they find him unsuitable and the contractor should forthwith remove him.

3.9 Planning and Execution:

Contractor shall submit a job planning in form of Bar Chart or PERT Chart. A List of manpower category wise, indicating individuals responsibility job activity wise, shall have to be submitted. Daily programme of job shall be displayed on board near work site on day in advance. A daily progress report along with Manpower utilities has to be submitted and backlog of the work, if any, shall be covered up in consultation with BHEL Resident Engineer.



**GENERAL & SPECIAL CONDITIONS
OF CONTRACT [FOR SERVICES JOB]**

**PSER
KOLKATA**

3.9 Safety and Accident Coverage

Contractor shall ensure safety of all his employees at site of work. All employees shall be covered by insurance (workmen compensation) against accident, failing which proper action will be taken against the contractor.

Contractor shall ensure proper safety of the equipments under overhauling by deputing personnel to guard the equipments round the clock. Open oil spaces, steam spaces shall be covered properly against ingress of foreign materials while working.

RESPONSIBILITIES OF THE CONTRACTOR IN RESPECT OF SAFETY OF MAN, EQUIPMENT, MATERIAL AND ENVIRONMENT

- 3.8.3.1 Before commencing the work, contractor shall submit a 'SAFETY PLAN' to the authorised BHEL official. The 'Safety Plan' shall indicate in detail the measures that would be taken by the contractor to ensure safety of men, equipment, material and environment during execution of the work. The plan shall take care to satisfy all requirements specified here under. The contractor shall submit safety plan along with his offer. During negotiations before placing or work order and during execution of the contract, BHEL shall have right to review and suggest modifications in the safety Plan. Contractor shall abide by BHEL decision in this respect.
- 3.8.3.2 The contractor shall take all necessary safety precautions and arrange for appropriate appliances as per direction of BHEL or it's authorised officials to prevent loss of human lives, injuries to personnel engaged, and damage to property and environment.
- 3.8.3.3 The contractor shall provide to it's work force and ensure the use of the following personal protective equipment as found necessary and as directed by the authorised BHEL officials:
- a. Safety Helmets conforming to IS-2925 : 1984
 - b. Safety Belts confirming to IS – 3521 : 1983
 - c. Safety shoes conforming to IS-1989 : 1978
 - d. Eye & Face Protection devices conforming to IS-8520 : 1987 and IS-8940 : 1978
 - e. Hand & body protection devices conforming to :
 - IS – 2573 : 1975
 - IS – 6994 : 1973
 - IS – 8807 : 1973
 - IS – 8513 : 1977
- 3.8.3.4 All tools tackles, lifting appliances, material handling equipment scaffolds, cradles, safety nets, ladders, equipment etc. used by the contractor shall be of safe design and construction. These shall be tested and certificate of fitness obtained before putting them to use and from time to time as instructed by authorised BHEL official who shall have the right to ban the use of any item.
- 3.8.3.5 All electrical equipment, connections and wiring for construction power, its distribution and use shall conform to the requirements of Indian Electricity Act & Rules. Only electricians licensed by the appropriate statutory authority shall be employed by the contractor to carry out all types of electrical works. All electrical appliance including portable electrical tools used by the contractor shall have safe plugging system to source of power and be appropriately earthed.



**GENERAL & SPECIAL CONDITIONS
OF CONTRACT [FOR SERVICES JOB]**

**PSER
KOLKATA**

- 3.8.3.6 The contractor shall not use any hand – lamp energised by electric power with supply voltage of more than 24 volts. For work in confined spaces, lighting shall be arranged with power source not more than 24 volts.
- 3.8.3.7 The contractor shall adopt all fire safety measures as laid down in the “Code for Fire Safety at Construction Sites” issued by the safety Department of the Construction Management (HQ) of BHEL and as per directions of the authorised BHEL official. A copy of the above referred “Code for Fire Safety at Construction Sites” shall be made available by BHEL to the contractor for reference, on demand by the contractor, during tendering stage itself.
- 3.8.3.8 Where it become necessary to provide and / or store petroleum products, explosives, chemicals, and liquid or gaseous fuel or any other substance that may cause fire or explosion, the contractor shall be responsible for carrying out such provisions and / or storage in accordance with the rules and regulations laid down in the relevant government acts, such as Petroleum Act, Explosives Act, Petroleum & Carbides of Calcium Manual of the Chief Controller of Explosives, Govt. of India, etc. Prior approval of the authorised BHEL official at the site shall also be taken by the contractor in all such matters.
- 3.8.3.9 The contractor shall arrange at his cost (wherever not specified) appropriate illumination at all work spots for safe working, when natural daylight may not be adequate for clear visibility.
- 3.8.3.10 The contractor shall be held responsible for any violation of statutory regulations (local, state or central) and BHEL instructions, that may endanger safety of men, equipment, material and environment in his scope of work or another contractor’s or agency’s Cost of damage if any, to life and property arising out of such violation of statutory regulations and BHEL instructions shall be borne by the contractor.
- 3.8.3.11 In case of a fatal or disabling injury, accident to any person at construction site due to lapses by the contractor, the victim and / or his / her dependents shall be compensated by the contractor as per statutory requirements. However, if considered necessary, BHEL shall have the right to impose appropriate financial penalty on the contractor and recover the same from payments due to the contractor for suitably compensating the victim and / or his/her dependents. Before imposing any such penalty, appropriate enquiry shall be held by BHEL giving opportunity to the contractor to present his case.
- 3.8.3.12 In case of any damage to property due to lapses by the contractor, BHEL shall have the right to recover cost of such damages from payments due to the contractor after holding an appropriate enquiry.
- 3.8.3.13 In case of any delay in the completion of a job due to mishaps attributable to lapses by the contractor, BHEL shall have right to recover cost of such delay from payments due to the contractor, after notifying the contractor suitably and giving him opportunity to present his case.
- 3.8.3.14 If the contractor fails to improve the standards of safety in its operation to the satisfaction of BHEL after being given a reasonable opportunity to do so, and/or if the contractor fails to take appropriate safety precautions or to provide necessary safety devices and equipment or to carry out instructions regarding safety issued by the authorised BHEL official, BHEL shall have the right to take corrective steps at the risk and cost of the contractor after giving a notice of not less than seven days indicating the steps that would be taken by BHEL.



**GENERAL & SPECIAL CONDITIONS
OF CONTRACT [FOR SERVICES JOB]**

**PSER
KOLKATA**

3.8.3.15 The contractor shall submit report of the accidents, fires and property damage, dangerous occurrences, to the authorised BHEL official immediately after such occurrence, but in any case not later than twelve hours of the occurrence. Such reports shall be furnished in the manner prescribed by BHEL. In addition, periodic reports on safety shall also be submitted by the contractor to the authorised BHEL official from time to time as prescribed.

3.8.3.16 Before commencing the work, the contractor shall appoint / nominate a responsible officer to supervise implementation of all safety measures and liaison with his counterpart of BHEL.

3.8.3.17 If safety record of the contractor in execution of the awarded job is to the satisfaction of safety Department of BHEL, issue of an appropriate certificate to recognise the safety performance of the contractor may be considered by BHEL after completion of the jobs.

3.9 Housekeeping and preservation:

3.9 Work floor/area shall be cleaned every day and be kept absolutely clean. A regular cleaning gang may be engaged for the purpose.

All dismantled components of the equipments under overhauling should be tag marked and stored properly according to type of components, namely all loose/small parts shall be kept in boxes bearing and matching components shall be kept on wooden planks. A list of such components shall be maintained to identify / locate be preserved properly against probable damages.

No floor shall be damaged while working and necessary steps shall be taken by the contractor for repair in case of any damage.

3.9 Tools stores and Consumables:

Tools & tackles, other than special tools and tackles supplied along with the equipments, shall be arranged and kept properly by the contractor. A register must be maintained and updated regularly.

All consumables, other than those going permanently into the equipment, shall be stored by the contractor for daily use. Regular check shall be made at end of each day's work and exhausted consumables shall be replenished immediately.

The store may be visited by BHEL Engineers without notice for verification.

3.9 The contractor shall make all necessary arrangement to receive spares from BHEL/Customer's stores, as and when required. The unused and scrap materials shall be returned to BHEL / Customer's stores on completion of the work.

A detailed account shall be submitted by the contractor to this effect at the end of the work certifying no dues remained against them duly signed by Resident Engineer BHEL/Customer.



**GENERAL & SPECIAL CONDITIONS
OF CONTRACT [FOR SERVICES JOB]**

**PSER
KOLKATA**

3.9 General:

- 3.9.1 Standard printed conditions if enclosed with the offer by the tenderers will not be accepted and only those in main body of the offer will be considered for acceptance.
- 3.9.2 The tenders are likely to be rejected if the tendered is not acceptable to the ultimate customer.
- 3.9.3 It will be the responsibility of the contractor to carry out trial run of all the equipments overhauled and confirm the satisfactory operation of equipment. The contractor's personnel shall also be present at time of final commissioning and attend to any defects that shall occur during this time.



SPECIFIC TERMS AND CONDITIONS
FOR SERVICES JOBS

PSER
KOLKATA

Annexure – V

A) TENDERING

1. Tenders may be submitted through Registered post with acknowledgement due, in the name of the addressee only indicated, or by hand delivery or by courier service obtaining acknowledgements of receipt. Telegraphic / Telex offers received in time can be considered, if only followed by acceptable written tender documents in accordance with the telex / telegram and does not result in any advantage over other tenderers because of any possible manipulation in price or date of completion etc.
2. Each and every page of tender documents from declaration of bidders to Annexure VI enclosed should be signed by the tenderer providing his / their seal and date as taken of their full acceptance of the scope of work, terms and conditions etc., and should be returned along with the tender offers.
3. The tenders should be quoted in English language and international numbers.
4. All entries in the tender shall be typed in ink legibly written without ambiguity.
5. Qualifications of Tenderers : for open tenders only, the tenderers who have previous experience in the similar nature of work as detailed in this tender specifications are expected to quote duly detailing their relevant experience / credentials along with the offer. Offers of other than the above are not likely to be considered. (List of similar jobs done) - Enclosure – 1
6. Financial Status : A current / valid certificate from a scheduled bank to provide the financial soundness / capability of the bidder to undertake the work, is required to be submitted along with offer. - Enclosure – 2
7. Income Tax / Sales Tax certificates : A certificate of income tax / sales tax clearance from the appropriate authority, is to be submitted in the form prescribed therefor, valid for the period of contract. - Enclosure - 3
8. Organization Chart : The organization pattern and that will be deployed by the tenderer for this work duly indicating the number of supervisors, their qualifications and experience in the line, the number of skilled and unskilled persons / etc. is required to be indicated in the offer. - Enclosure – 4
9. THE FOLLOWING DOCUMENTS SHOULD ALSO BE ENCLOSED.
 - a) An attested copy of the power of attorney in case the tender is signed by an individual other than the sole proprietor.
 - b) In case of an individual his full name, address, nature of business and valid trade licence.



SPECIFIC TERMS AND CONDITIONS
FOR SERVICES JOBS

PSER
KOLKATA

- c) In case of partnership firm, the names of all partners and their addresses. (A copy of the partnership deed / instrument of partnership, duly attested by the Notary public shall be enclosed.)
- d) In case of companies, date and place of incorporation / registration including date of commencement certificate (for public companies). (Certified copies of Memorandum and articles of association are also to be furnished).

B) EARNEST MONEY DEPOSIT :

For this, please refer article 1.4 (page 4 of 23) of the General and special conditions of contract – 1991 (GSCC) enclosed / supplied with the form issued for empanelment.

C) VALIDITY OF OFFER :

The rates in the tender shall be kept open for acceptance for a minimum period of six months from the due date of opening of tenders. For details, please refer article 1.6 (page 7) of GSCC enclosed.

D) SECURITY DEPOSIT:

As per clause no. 1.8 of GENERAL & SPECIAL CONDITIONS OF CONTRACT [FOR SERVICES JOB].

Return of Security Deposit:

If the contractor duly fulfils the contractual obligations as per contract in all respects to the entire satisfaction of BHEL, and presents an absolute “No Demand Certificate” in the prescribed form and return properties belonging to BHEL handed over, lent or hired by him for carrying out the said works the security deposit will be released to the contractor after deducting all costs or expenses or other contracts entered into with the contractor, irrespective of release of last 10% payment. In no case Security Deposit can be released before settling all claims of BHEL on contractor under this contract.

No interest shall be payable by BHEL on Earnest Money / Security Deposit or any money due to the contractor from BHEL.

E) ACCEPTANCE / REJECTION OF TENDERS :

For this, please refer article 1.9 (pages 6 to 10) of GSCC enclosed. Also acceptance of customer is pre-requisite for consideration of bid, wherever applicable.

F) ADDITIONAL SPECIFIC TERMS AND CONDITIONS :

01. EXECUTION.

- i) If the site in question is subjected to industrial relations unrest / disturbances / problems, then the successful bidder should take adequate precautionary measures against dislocation of the job on account short



SPECIFIC TERMS AND CONDITIONS
FOR SERVICES JOBS

PSER
KOLKATA

problems. Any liability on this account, lies entirely with the contractor.

- ii) The contractor shall commence the work at site with full manpower, T&P etc. and complete as specified in the particulars of the tender. In case of any delay on the completion of work attributable to the contractor BHEL reserves full rights to cancel the contract fully or partly and to award the job in full or part to an alternate agency and recover the costs towards the same including BHEL's overheads from the contractor.
- iii) In the event of termination of contract or restriction of quantum of job by our client, before or during the execution of contract, BHEL reserves the right to terminate the contract or restrict the quantum of work of sub-contractors accordingly without paying any compensation.
- iv) Manpower: For various category of manpower and their numbers recommended, please refer to the Annexure IV of the tender enquiry. The contractor shall engage proper skilled / qualified personnel and ensure the expected quality of work. If any of their personnel has been found to be unsuitable, by BHEL / or their client, the contractor shall withdraw them and provide suitable replacement immediately, failing which BHEL reserves full rights to get the job done by alternate suitable persons at risk and cost of the contractor. The delay on this account is attributable to the contractor.
- v) TOOLS (TACKLES & PLANTS) : All tools, tackles and plants including precision measuring instruments, lifting devices shall have to be arranged by the contractor. (List of recommended T&P, for guidance, is provided in Annexure II of the tender enquiry). All lifting tackles and pulling devices to be used must bear valid / latest test certificates for their suitability, and the sales tax furnished along with the offer itself.

Also certificates of test / calibration with date of validity for various measuring / test instruments have to be submitted by the tenderer preferably along with the offer itself, or else the same is required to be produced at site before start of job failing which the LOI / W.O. is liable to be cancelled without any compensation.

Successful bidder shall provide valid calibration certificates for IMTEs, fitness certificates for T&Ps and Construction Equipment (e.g. wire ropes, hand operated chain pulley blocks, pulling and lifting machines, electric welding generators, arc welding transformers etc.). Calibration of IMTEs is to be arranged from the accredited agencies. Calibration certificates should have the traceability as per national/international standards. At work site the IMTEs, T&Ps and Construction Equipment shall be checked/tested/inspected by BHEL engineers. The procedure for fitness testing and storage preservation and maintenance of Construction Equipment and T&Ps shall be as per Doc. Nos. PSER:FEX:001:94, PSER:SAS(CAL):016:95 and PSER:FEX:002:94 available with BHEL site engineers.

- vi) CONSUMABLES: All consumables required (list for guidance is given in Annexure III of the tender enquiry) for the job shall be arranged by the contractor



SPECIFIC TERMS AND CONDITIONS
FOR SERVICES JOBS

PSER
KOLKATA

at his cost. However, any spares / components / consumables / materials going permanently into the clients equipment shall be provided to the contractor.

- vii) Successful bidder has to arrange proper storing facilities at site with traceabilities for IMTEs, T&Ps, construction equipments and consumables used during job execution.
- viii) All the T&Ps, consumables etc. must be mobilized at site at least three days prior to actual start of the job. They must be in accordance with those recommended in the Annexure – II and III respectively of the Tender Enquiry and must be got verified to that effect. Formal clearance in writing must be obtained from BHEL's resident engineer before the contractor starts the job.

T&P found defective / improper / insufficient or not having valid test / calibration certificate should be made good immediately.

If the contractor fails to mobilize at least 90% of the recommended T&P and manpower within the stipulated period, the order on the contractor is liable to be cancelled without paying any compensation on to him.

- viii) Storage : The contractor shall be responsible for proper storing of all dismantled components, spares, T&P etc., identify them properly and preserve them throughout the execution of the job. Any loss or damage of the components caused due to the lapses attributable to the contractor or his personnel, shall be chargeable to the contractor.

- ix) Transportation of Spares / materials / consumables :

Any material / components / spares required for the work must be collected by the vendor and carried safely to the work site from the point of issue in our clients premises, through his own resources and cost.

Similarly, excess materials / spares etc. must be returned to the client's stores / any other place, within the client's premises, indicated by site-in-charge of BHEL.

Any debris, rubbish at the work spot must be cleared very day by the contractor using his own resources and cost, and disposed off at a placement for, as to be informed to him.

- x) Space / Accommodation :

The contractor will be allowed to have his site office, stores etc. by erecting temporary partitions / chambers / sheds etc. at the work spot according to the availability of space, which will have to be vacated and dismantled at the end of the jobs to restore the space to the client. The contractor should make his own arrangements for the security / watch and ward.

No residential accommodation / spare can be provided by BHEL to the contractor for any residential accommodation of his personnel. Contractor



SPECIFIC TERMS AND CONDITIONS
FOR SERVICES JOBS

PSER
KOLKATA

has to make arrangements/accommodation at site at his cost.

xi) The contractor shall ensure responsible execution of the job and proper behavior of their personnel and observance of all the rules and regulations of our clients.

xii) Safety :

a) Standard safety norms/ regulations shall be conserved by the contractor during the execution of the job. The contractor should provide the necessary / stipulated safety devices to his personnel deputed to the site, such as grinding / welding goggles, masks, safety belts, helmets etc. No worker will be permitted to work without necessary safety appliances. Delay of work due to work without necessary safety appliances. Delay of work due to these lapses are attributable to the contractor.

b) All norms related to Health, Safety & Environmental (HSE) norms conforming to ISO-14001 & OHSAS-18001 shall be followed by successful bidder. Bidders may contact SAS-PSER office for getting detailed norms to be followed by bidder at Site

c) The contractor shall comprehensively insure all his site personnel against any hazard / accident and submit a copy of the insurance certificate covering all his site personnel to our resident engineer before commencement of work.

d) In case of any accident / hazard, the contractor shall arrange for medical attendance immediately shall compensate the personnel concerned in accordance with the workmen's compensations act in force and shall keep BHEL indemnified against any provisions of the act.

e) The successful bidder is to arrange a full set of First Aid kit for attending to manpower deployed by him at site as per requirement.

f) Successful bidder should follow all safety norms at work site. The Doc. No. PSER:PMX:004:94 in this regard is available with BHEL engineer at site.

02. STATUTORY COMPLIANCE :

i) The contractor shall comply with all state and central laws, statutory rules regulations etc. such as :

The payment of wages act, maximum wages act, workmen's compensation act., industrial disputes act, employees provident funds act / scheme, Employees' state insurance scheme, contract labour (Regulation & abolition) act, 1970 etc. and all other acts, rules & regulations for employment of labour as may have been and as may be enacted by the Government during the tenure of the contract and having force or jurisdiction at site. The contractor shall give to the local government body, police, labour authorities and other relevant authorities and all such intimation and notices as may be required by law and appraise BHEL site-in-charge of such compliance.



SPECIFIC TERMS AND CONDITIONS
FOR SERVICES JOBS

PSER
KOLKATA

- ii) The contractor shall pay all taxes, fees, licence charges, deposits, duties, fines, royalty commissions or other charges which may be leviable on account of any of his operations in executing the contract. In case, BHEL is forced to pay any of such taxes, BHEL shall have the right to recover the same from the contractor either form his bills or other issue as deemed fit.
- iii) The contractor shall obtain requisite licence from appropriate authority of the ministry of labour under the provision of the contract labour (Regulation and abolition) Act as soon as the work is avoided to him and indemnify BHEL against the application of any provisions of the act.
- iv) The contractor shall be responsible for provision of welfare and health of his employees / workmen, more particularly described in the contract labour (Regulation & abolition) act / rules, and safety precautions etc., as may be required for satisfactory execution of the contract.
- v) The contractor shall fulfil all his obligations in respect of canteens, rest rooms, accommodation including proper medical facilities etc. for the personnel employed by him, more particularly described in the contract labour (regulation & abolition) act / rules.
- vi) The contractor will be directly responsible for payment of wages to his workmen more specifically described in the contract labour (regulation and abolition) act / rules. A pay roll sheet showing all the wage payments representative should be furnished to BHEL site office for record purpose. BHEL site in-charge may be intimated the date of disbursement of wages to the workmen engaged for the work; so that his representative can witness the same. The contractor shall indemnify BHEL against any statutory liability on account of dues to his workmen.
- vii) The bidders should be having appropriate licence from the local Boiler Inspectorate if the job involves welding of pressure parts. Also they should be having alloy steel / carbon steel high pressure welders (for PIG and submerged arc welding approved by the local Boiler Inspectorate for welding the pressure parts. The bidders should clearly indicate the same in the offer.



**SPECIFIC TERMS AND CONDITIONS
FOR SERVICES JOBS**

**PSER
KOLKATA**

03. TERMS OF PAYMENT:

- i) No advance shall be payable to the contractor unless specifically spelt out in the tender enquiry.
- ii) A minimum time of fifteen days will be required for the processing of bills presented and for their payment.
- iii)
 - a) **80% of the contract value shall be payable against submission of three progressive running bills. Each of the billed amount shall correspond to the quantum of job actually completed and to that effect the claim can be preferred based on percentage allotments (to be given in the work order) made. This, however, has to be certified by the resident manager / engineer of the site.**
 - b) **10% of contract value shall be payable on submission of statutory documents & 'no due certificate from customer's personal department/receipt of final payment by BHEL from customer'.**
 - c) **Balance 10% of contract value shall be payable after successful synchronization / commissioning and on receipt of final payment by BHEL from Customer.**

BHEL at its discretion may further split up the percentage break up given in billing schedule and effect payment to suit site condition, cash flow requirement etc. according to progress of work.

- iv) The bidder should be financially sound to maintain the site establishment with regard to timely payment of wages to his workmen, arrangements of other inputs viz. T&P consumables etc.

Non-receipt of progressive payment from BHEL due to any reasons should not be a constraint for the smooth execution of the job at site.

- v) The bidder should make all out efforts to provide all inputs in consultation with BHEL engineers at site for completing the job in the specified time frame.
- vi) No over run/escalation / idle charges are payable against any services job under any circumstances. (in exceptional cases such claims may be considered provided BHEL's customer admits of such payment).
- vii) Extra work rate being admitted off by BHEL for other similar contracts have been stated on the page no.10 of this annexure.

For any additional work not envisaged in the scope of work or quantities exceeding the stated quantities, these rates shall be applicable.

- viii) All claims for extra works should be settled before claiming the final (10%) bill. The contractor should prefer the final claim with the certificate that 'no other claim is due from BHEL against this contract', without which final bill cannot be processed for payment.
- ix) For reduction / deletion / withdrawal in the scope of work proportionate deduction in contract value will be made.

4. PERFORMANCE:

- i) As soon as job is awarded, the contractor has to submit a barchart to the



SPECIFIC TERMS AND CONDITIONS
FOR SERVICES JOBS

PSER
KOLKATA

resident engineer nominated showing the detailed schedule for all activities.

This schedule will be reviewed by the resident engineer from time to time to enable the contractor to recast the barchart matching the planned completion of the job.

- ii) It shall be the responsibility of the contractor's supervisor to distribute the work among his workmen deployed at site and get day to day activities executed as per BHEL's requirement.

BHEL's engineers / supervisors will check the correctness of the job done and will also give the daily programme of work to the contractors supervisor. The contractor has to ensure completion of daily programme and if there is any spill over, the same has to be completed by putting in same additional resources. (Technical guidance wherever required will be provided by BHEL).

- iii) The scope of work mentioned in this tender enquiry gives the broad outline of the actual work involved and it not is possible to mention all minute details of the work. For proper evaluation, the bidders may seek clarifications from this office. Or else, they may visit site and study the job content before submitting offers and be well informed and acquainted with the actual working and other prevalent conditions of the site, facilities available etc.

No claim will be entertained later on the ground of lack of knowledge. iv)

The bidders have to furnish the bio-data and experience details of the site-in-charge, other key workmen, supervisors, senior technicians etc. to be deployed. In case of award of contract, the key members of the contractor's team may be interviewed at site by BHEL's resident engineer to ascertain their suitability. Replacement of non-acceptable personnel will have to be arranged by the contractor immediately at his own cost.

- v) Penalty for the delay in job completion will be 0.5% per day of delay, limiting to maximum 10% of the contract value, to be imposed on the contractor in case the delay in work completion is attributable to the lapses on the part of the contractor.

In case of LD recovery, the applicable GST shall also be recovered from vendor.

- vi) **Performance Security towards Warranty Obligations/ Defect Liability:**

The value of Performance Security towards Warranty Obligations/ Defect Liability to cover the performance guarantee period shall be 5% of the contract value.

Performance Security towards Warranty Obligations/ Defect Liability may be collected in any one of the two alternatives:

- i) SD amounting to 3% may be retained as part of Performance Security and thereafter the same shall be termed as 1st part of Performance Security valid up to the entire performance guarantee period.



**SPECIFIC TERMS AND CONDITIONS
FOR SERVICES JOBS**

**PSER
KOLKATA**

The balance amount of performance Security to cover the total amount of performance Security shall be submitted (valid from the date of commissioning/synchronization of the set after the overhaul and valid up to entire performance guarantee period/defect liability period) by contractor in the form & manner as mentioned under cl. No. 1.8 of General & Special Conditions of Contract [For Services Job]. In case the SD submitted in BG, conversion of the same as part of Performance Security shall be done on vendor's request and if the balance 2% performance security is submitted in the form of BG, same shall be submitted in PBG format prescribed in tender documents.

OR

ii) Contractor may also submit performance security of 5% of contract value at the start of guarantee period in the form of PBG valid up to entire guarantee period. In such case sl. No. i) shall not be applicable.

If requisite Performance Security is not submitted within 7 days of commissioning/synchronization/job completion (as appl.), Interest @ SBI PLR +2% will be charged.

Performance Guarantee: Even though the work will be carried out under supervision of BHEL Engineers, the contractor shall guarantee against defects attributable to faulty workmanship or procedure adopted in the overhaul for items covered in the contract for a period of Six months from the date of commissioning/synchronization of the set after the overhaul. The guarantee should cover all defects notified during this period and shall have to be attended free of cost immediately or at the time our clients are able to give shutdown of the set for the required period, when necessary. In case of failure of contractor to attend to the defect as and when required in time, BHEL shall arrange to attend the defects and the charges shall be levied to the contractor's account and shall be recoverable from the Performance Security towards Warranty Obligations/ Defect Liability / Performance Bank Guarantee / progressive payments.

Return of Performance Security towards Warranty Obligations/ Defect Liability: This Performance Security shall be released after successful completion of performance guarantee period.

5. **MISCELLANEOUS :**

- i) The bidders shall submit a list of jobs being carried out by them or expected to be taken up by them during the period as called for in the participation of the tender.

Enclosure – 6.



SPECIFIC TERMS AND CONDITIONS
FOR SERVICES JOBS

PSER
KOLKATA

- ii) The contractor has to engage a cleaning gang at site to ensure continuous cleaning of the floor at work site to protect the parts and to give safe access at the work site.
- iii) Obtaining licenses / permits / road permits in connection with the fulfillment of the contractual obligations is entirely the contractors responsibility. However, wherever applicable BHEL can only offer support to the extent possible.
- iv) For all matters bearing on the execution of the job at site, the decisions of the resident engineer are final and binding upon the contractor.
- v) The contractor has to retain suitable minimum work force at site for a period of one month from the date of completion or work / commissioning, to attend any small / miscellaneous problems, as leakage etc.
- vi) The contractor has to mobilize on a short notice (within 4 days) to attend any troubles encountered in the equipment worked on, during warranty period of six months.
- vii) After dismantling and during execution of the job, successful bidder has to suitably tag the components and sub-assemblies for traceability and store properly before final assembly. This is as per Doc. Nos. PSER:PMX:002:94 & PSER:PMX:001:94.
- viii) Process control of Special Processes like Welding and Heat Treatment shall be carried by successful bidder as per Doc. Nos. PSER:QLY:001:99, PSER:QLY:001:94 (3 VOL) and PSER:QLY: 003:99.
- ix) Proper segregation, identification, tagging and up-keep of all dismantled items at work site during job execution have to be done by successful bidder.
- x) Successful bidder is to obtain necessary "No Dues" certificates before de-mobilisation from site.
- xi) Any NDT within the scope shall be as per Non-Destructive Examination manual (Doc. No. PSER:QLY:002:99 available with BHEL site engineer).
- xii) Unless otherwise mentioned specifically in this tender elsewhere, the storage & preservation of components, sub-assemblies, IMTEs, T&Ps, Construction Equipments etc, maintenance of stores, watch and ward of stores and BHEL site office is in the scope of the successful bidder.
- xiii) The successful bidder is to arrange extra illumination at work site to augment the existing site illumination if required to enable round-the-clock safe working.

Note: Any of the documents mentioned above can be referred before submission of tender at the office of PSER:SAS(CAL).



SPECIFIC TERMS AND CONDITIONS
FOR SERVICES JOBS

PSER
KOLKATA

EXTRA WORK RATES CURRENTLY BEING ADMITTED BY BHEL, PS-ER

A. **MAN-HOUR RATE FOR ELIGIBLE EXTRA WORKS:** Single composite average labour man-hour rate, including overtime if any, supervision, use of tools and tackles and other site expenses and incidentals, consumables for carrying out any major rework/repairs/rectification/modification/fabrication as certified by site as may arise during the course of erection, testing, commissioning or extra works arising out of transit, storage and erection damages, payment, if found due will be at Rs.108/- per man hour.

B. The following all inclusive rates will be applicable for modification work involving welding of high pressure butt joints only. Extra work involving other types of joints will be done on the above manpower basis.

Unit rate per equivalent joint of size OD 63.5 mm x 6.3 mm thick

Average unit rate per equivalent joint,
including NDT and stress relieving.

Carbon Steel

Rs.200/- (Rs. Two hundred only)

Alloy Steel

Rs.250/- (Rs. Two hundred fifty only)



SPECIFIC TERMS AND CONDITIONS
FOR SERVICES JOBS

PSER
KOLKATA

List of enclosure to be furnished by the bidder along with tender documents.

- | | | |
|----|---|----------------|
| a) | Experience certificate | Enclosure 1 * |
| b) | Banker's certificate of financial soundness as per BHEL' format | Enclosure 2 * |
| c) | IT / ST clearance certificate | Enclosure 3. |
| d) | Organisation Chart | Enclosure 4. * |
| e) | List of concurrent jobs held by the contractor / bidder. | Enclosure 5. |
- (* Vendors registered with BHEL should submit documents in support of sl. no. c only.)

List of documents to be furnished by the contractor to the resident engineer before commencement of the jobs / during the execution.

- i) Barchart (if not furnished in the offer)
- ii) List of T&P being mobilized. Test / Calibration certificate with date of validity for lifting / pulling devices and measuring / test instrument (if not furnished in the offer).
- iii) Category wise list of manpower being mobilized. iv)
List of consumables being mobilized.
- v) Licence from the department of Labour under contract Labour (Regulation & Abolition) Act / Proof of Application for Licence.
- vi) ESI coverage, if applicable.
- vii) Insurance certificate covering the site personnel.
- viii) Proof of remittance of provident fund to the concerned authorities, for all workmen employed for this job.
- ix) Third party insurance coverage.



**SPECIFIC TERMS AND CONDITIONS
FOR SERVICES JOBS**

**PSER
KOLKATA**

ANNEXURE - VI

QUESTIONNAIRE TO BE FILLED IN BY THE BIDDER, SIGNED WITH DATE AND
SEAL, AND TO BE RETURNED ALONG WITH TECHNICAL TENDER.

BIDDER'S NON-ACCEPTANCE OF TENDER REQUIREMENTS CAN DISQUALIFY HIS BID FOR OPENING OF "PRICE BID"

TENDER NO: PSER:SCT:

DATE:/...../20.....

- 01 NAME OF THE ORGANISATION.
ADDRESS, TELEPHONE / FAX NO. :
-
.....
.....
.....
- 02 MODE AND PARTICULARS OF EMD
ENCLOSED
- 03 BANKER'S CERTIFICATE FOR FINANCIAL SOUNDNESS / CAPABILITY TO UNDERTAKE WORK. : Enclosed / Not enclosed.
04. IS THE FIRM HAVING VALID TESTED / CALIBRATED TOOLS AND MEASURING INSTRUMENT REQUIRED FOR THIS TYPE OF JOB AND EQUIPMENT. : YES / NO.
05. ORGANISATION CHART / MANPOWER : Enclosed / Not enclosed.
06. STATUTORY REQUIREMENTS AS PER RELEVANT ACTS WITH LATEST AMENDMENT (Pl. tick out) :
- i) LICENCE FOR EMPLOYING CONTRACT LABOUR : Will be complied with
- ii) MINIMUM WAGES ACT : - do -
- iii) INSURANCE OF SITE PERSONNEL EMPLOYED. : - do -
- iv) WORKMEN'S COMPENSATION ACT : - do -
- v) THIRD PARTY INSURANCE : Will be complied with
- vi) EMPLOYEE'S LIABILITY ACT
- vii) INDUSTRIAL DISPUTES ACT : - do -
- viii) EMPLOYEE'S PROVIDENT FUNDS ACT : - do -



SPECIFIC TERMS AND CONDITIONS
FOR SERVICES JOBS

PSER
KOLKATA

- ix) CONTRACT LABOUR : - do -
(REGULATION AND ABOLITION)
ACT / RULES
- x) SAFETY APPLIANCES / DEVICES : - do -
FOR WORKMEN
- xi) BOILER INSPECTORATE : - do -
- xii) ARBITRATION ACT : - do -
07. **AGREEABILITY TO “NO OVERRUN : Agreeable
CHARGES” CLAUSE**
08. **AGREEABILITY TO “NO IDLE TIME : Agreeable
CHARGES” CLAUSE**
09. **AGREEABILITY TO EXECUTE FULL : Agreeable
SCOPE OF WORK OF TENDER ENQUIRY
(INCLUDING RELATED MINOR
ACTIVITIES).**

Signature of the bidder :

Date :

Name of the person signing :

Designation :

SEAL
